

index.

diagnostic endoscopy.	4 - 41
arthroscopy.	42 - 83
laparoscopy.	84 - 113
devices.	114 - 136





passion for animals.

Spitz VetCare is your competent partner for endoscopic technologies. We provide all for your minimal invasive approach, from laparoscopy, arthroscopy to diagnostics.

From needle holders to high-resolution 4K UHD cameras or customized special products, we have an exclusive product portfolio for your needs.

Dr. med vet Markus Spies has been in veterinary medicine for 20 years, as a clinician and in industry. SPITZ VetCare was founded in 2021 as a subsidiary of the Tuttlingen-based family company RZ Medizintechnik GmbH.

And that is what Spitz VetCare is all about: The clinical experience and passion of veterinarians combined with experience in developing and manufacturing medical technology make Spitz VetCare a strong partner.

For us, veterinary medicine is not just a subsidiary of human medicine, but an important part of modern medical technology.





diagnostic endoscopy.





- Wide range of flexible, semiflexible and rigid instruments
- Dedicated equipment for the Rhinoscopy, Laryngoscopy, Otoscopy or Vaginoscopy and Cystoscopy
- Different scopes and sheaths for all kind of indications
- For diagnosis and treatment in all natural orifices

Universal and flexible "All in One Solution" for diagnostics and endoscopic therapy. The complete system can be easily transported, intuitively set up and used. The ultra-high resolution monitor and FullHD camera produce a high-quality image and the 60W equivalent light source provides good illumination.

- 4K HD 17,3" monitor
- LED Light Source, 60W equivalent
- Disinfectable FullHD camera for flexible and rigid optics with zoom adapter
- Endoscopic platform with video and image recorder and network connection

300-490-001

ALL IN ONE FULL HD SYSTEM

consisting of:

- A Camera head, Full HD
- B TV-Adapter, f1.4 to f3.5
- C Light guide cable with adapter
- D Laptop with software, LED Light source
- E Suitcase



Mobile endoscopy becomes possible with this High Definition camera that allows endoscopic examination with all required parts in one complete set. Integrated illumination and a high-performance camera head, powered by an external Desktop-Computer or Laptop via USB 3.0 makes examination and clinical surgery possible.

- Full HD (1920 x 1080) recording function (images / video)
- Powered by USB connection (USB 3.0 required)
- Long-life LED illumination
- Programmable camera head with adjustable brightness
- Easy software installation and interface (Software incl. patient management/storage)
- Lightweight, ready-to use design

300-001-480

FULL HD CAMERA SET

consisting of:

- A Camera head
- B Endoscope coupler
- C Light source
- D Suitcase
- E Software



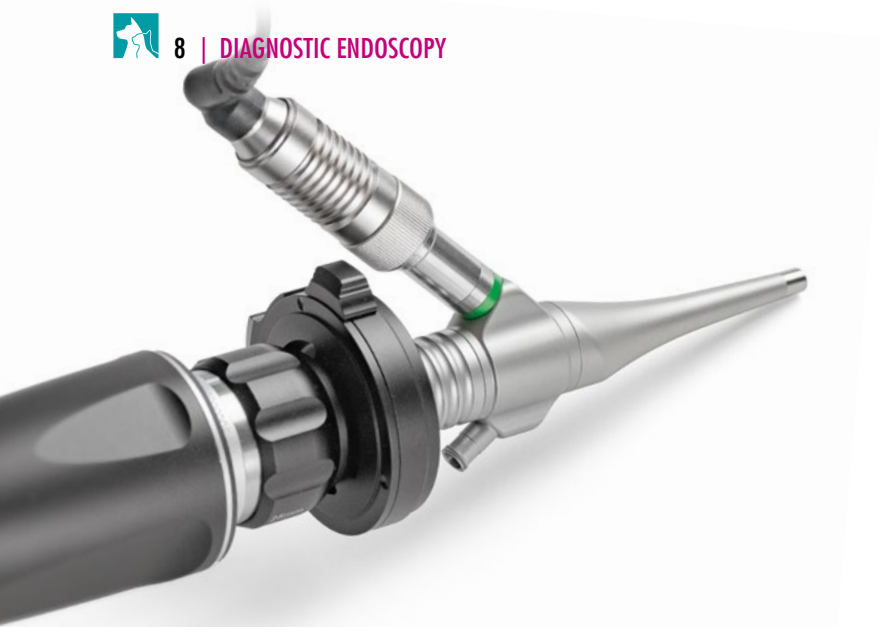

Otoscope, 5 Charr., Ø 4mm, 65mm working length

0°

410-005-000

Semi-rigid Instruments

- 280mm working length
- 5 Charr.



Stone Grasping Forceps, double action

semi-flexible

253-200-128

flexible

253-202-005

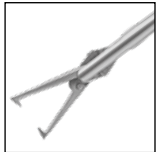

Large Stone Grasping Forceps, double action

semi-flexible

253-200-228



Biopsy Forceps, double action

semi-flexible

253-200-328

flexible

253-204-005



LuerLock connection, rotatable

253-000-302



LuerLock tube connector with stopcock

300-011-179

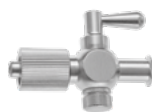

LuerLock one-way stopcock

300-011-515

ENT
Otoscopy

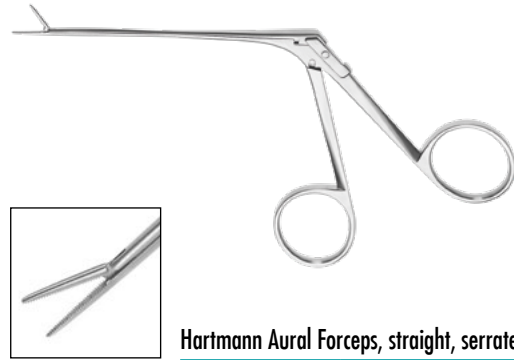

Hartmann Aural Forceps, straight, serrated
1 x 8mm 410-210-085

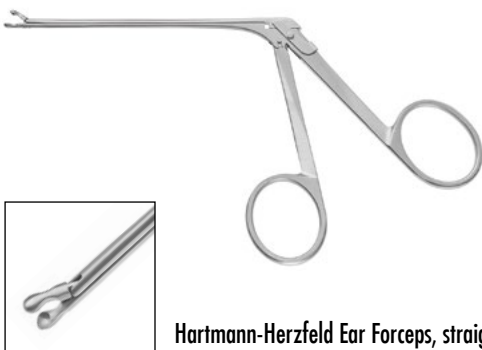

Hartmann-Herzfeld Ear Forceps, straight, 87mm working length
2.5mm spoon 410-338-136

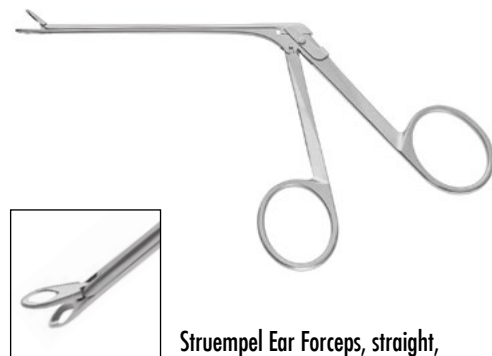

Struempel Ear Forceps, straight, 87mm working length
2.5 x 7.0mm 410-338-134

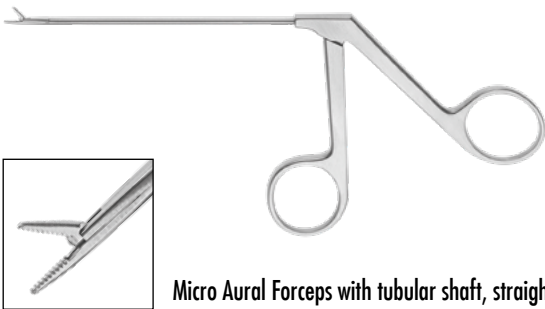

Micro Aural Forceps with tubular shaft, straight 80mm working length
0.8 x 3.5mm 410-330-000



Cotton Applicator, rough spiral end, Ø 1.5mm
180mm 160-412-180



Farrell Cotton Applicator, triangular, Ø 0.9mm
120mm 160-426-120
140mm 160-426-140

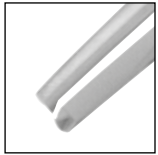

**Troeltsch Aural Tissue Forceps, 1 x 2 teeth,
knee bent**

125mm

410-377-120



**House Curette, sharp, double ended, oval cups,
strongly curved, 1.0 x 1.2mm**

150mm

410-044-003



**Williger Double Curette, oval/oval
#0/1 (Ø 3.0/3.5mm)**

140mm

210-216-001



ENT

Rhino/Naso

Rhinology / Nasopharyngeal Endoscopy

Equipment and instruments for the visualization in
the nasopharyngeal area





Set for
DOGS

Ø2.7mm



Sinuscope, Ø 2.7mm, 180mm working length

- 0° 252-127-000
- 30° 252-127-030
- 70° 252-127-070

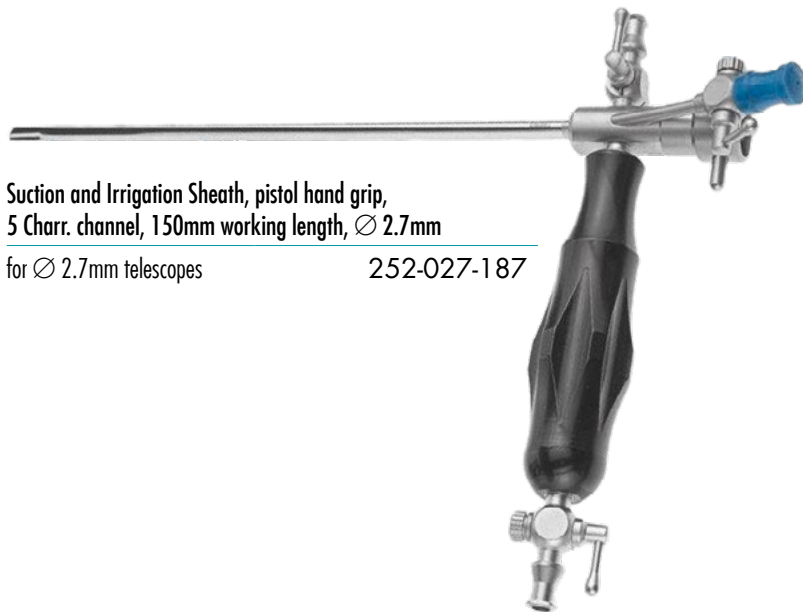

Suction and Irrigation Sheath, pistol hand grip,
5 Charr. channel, 150mm working length, Ø 2.7mm

for Ø 2.7mm telescopes 252-027-187

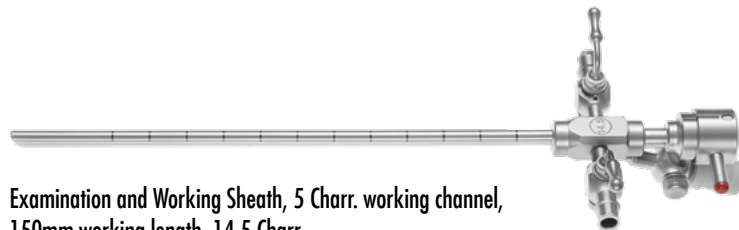

Examination and Working Sheath, 5 Charr. working channel,
150mm working length, 14.5 Charr.

for Ø 2.7mm telescopes 252-027-185



Cleaning brush, flexible, Ø2.5mm
120cm length, for 5 Charr working channel

253-961-102



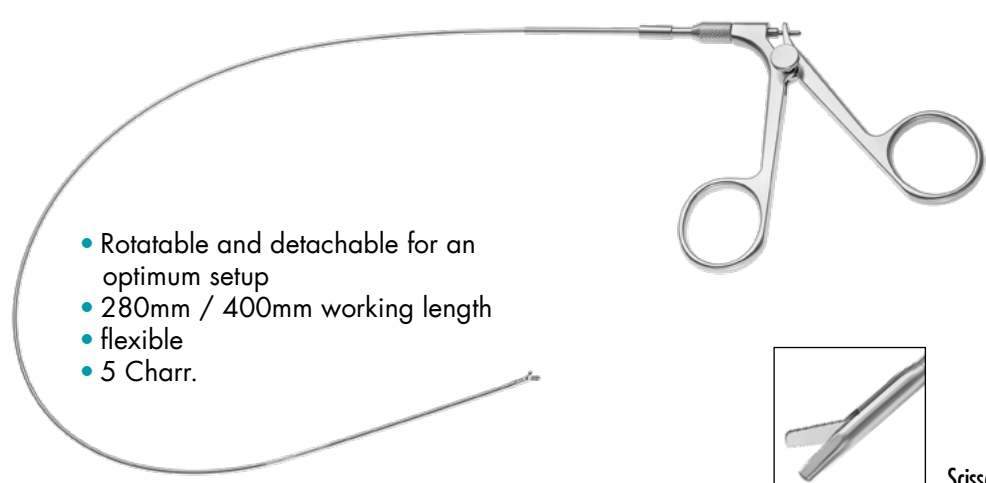

- Rotatable and detachable for an optimum setup
- 280mm / 400mm working length
- flexible
- 5 Charr.

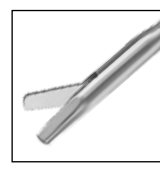

Scissors, single action	
400mm	351-100-105
280mm	253-203-003



Grasping Forceps, serrated jaws, double action	
400mm	351-114-105
280mm	351-202-005

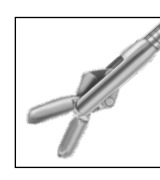

Biopsy Forceps, oval cup, double action	
400mm	351-120-105
280mm	253-202-005

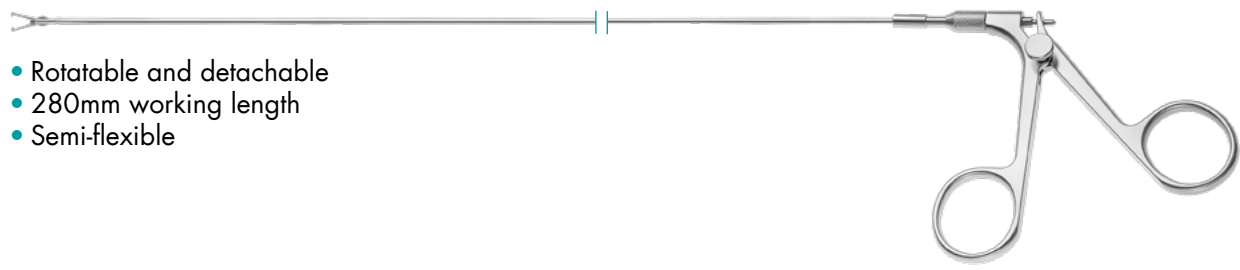

- Rotatable and detachable
- 280mm working length
- Semi-flexible

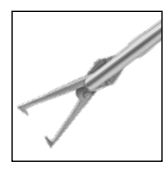

Large Stone Grasping Forceps, double action	
5 Charr.	253-200-228



Scissors, single action	
5 Charr.	253-200-228

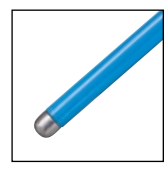

Ball Electrode, monopolar, 530mm length	
5 Charr.	253-370-005



Needle Electrode, monopolar, 530mm length	
5 Charr.	253-371-005

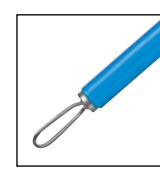

Loop Electrode, monopolar, 250mm length	
5 Charr.	253-372-005



Set for
CATS

Ø2.0mm



Mini Scope, Ø 2.0mm, 120mm working length

0°	253-221-000
30°	253-221-030

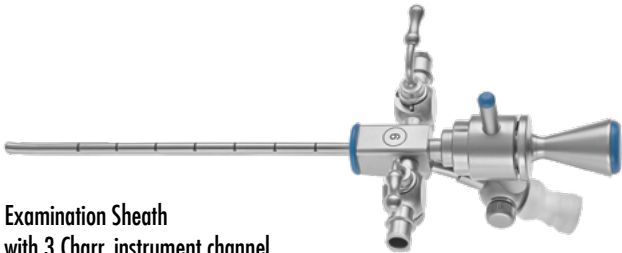

Examination Sheath
with 3 Charr. instrument channel,
atraumatic tip

9 Charr. / 3mm	253-200-009
----------------	-------------

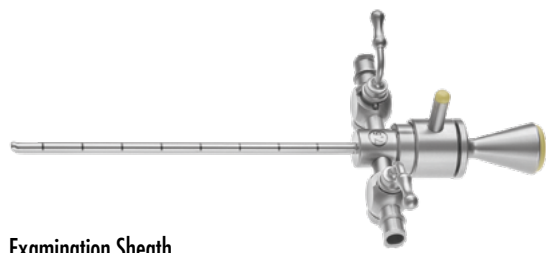

Examination Sheath,
atraumatic tip

7.5 Charr. / 2.5mm	253-200-007
--------------------	-------------

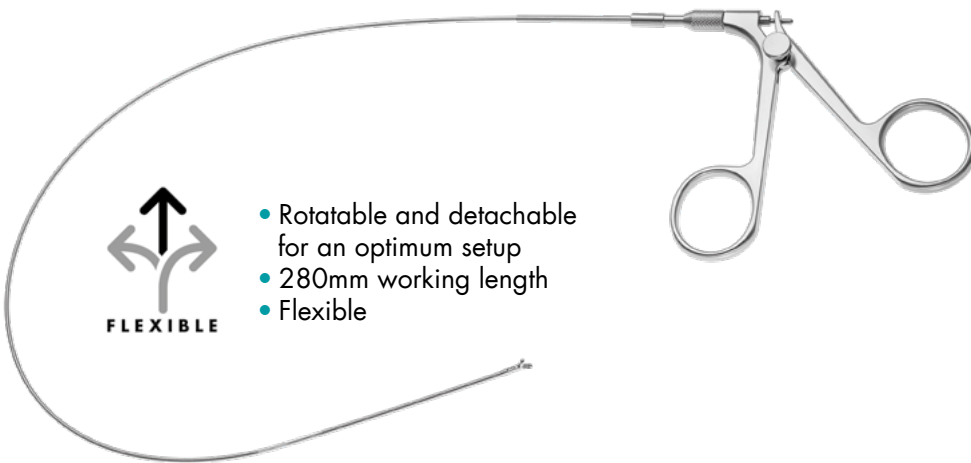

- Rotatable and detachable for an optimum setup
- 280mm working length
- Flexible



Alligator Grasping Forceps, double action, 3 Charr.

semi-flexible	253-202-003
flexible	253-203-003

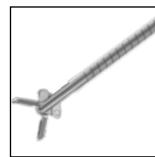

Biopsy Forceps, double action

3 Charr.	253-204-003
----------	-------------

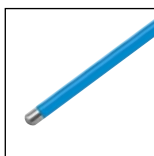

Ball Electrode, monopolar, 250mm length

3 Charr.	253-370-253
----------	-------------

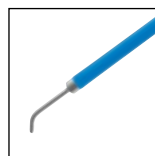

Needle Electrode, monopolar, 250mm length

3 Charr.	253-371-253
----------	-------------





*Visualization
with minimal equipment*

LED Portable Lightsource, with 1700mAh charger

300-001-183





Instruments for endoscopically assisted and open treatment



Halle-Tieck Nasal Speculum, screw joint, 130mm total length

17.5mm blade length

420-140-135



**DJ Forceps, double action
400mm working length**

7 Charr.



FLEXIBLE

351-107-107



**DJ Forceps, double action
400mm working length**

7 Charr.



**SEMI
FLEXIBLE**

351-107-307

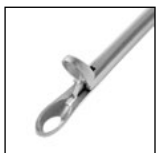

Blakesley Nasal Forceps, 150mm working length

3.5mm

252-035-150

4.0mm

252-040-150

5.0mm

252-050-150

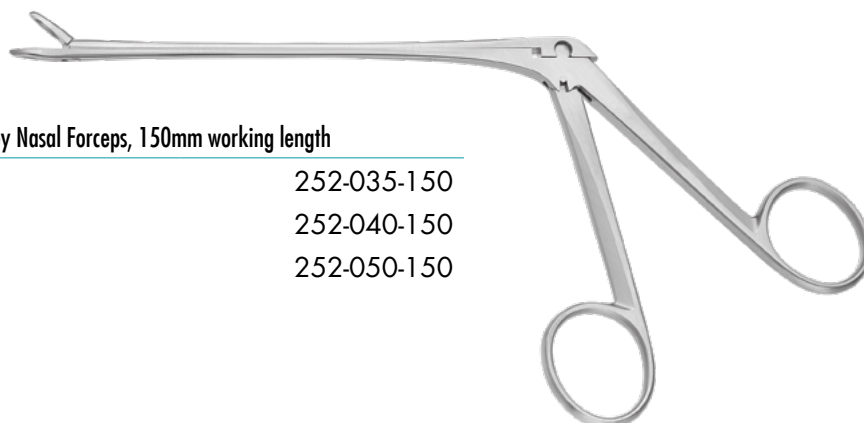



Noyes Nasal Forceps, 115mm working length

fenestrated jaw

252-527-115



**Biopsy and Grasping Forceps, delicate pattern,
140mm working length**

3mm oval cup

252-503-140

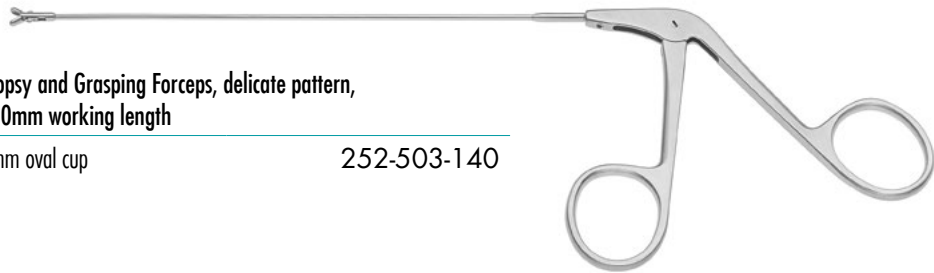

**Struempel Nasal Forceps with
oval fenestrated cupped jaws
120mm working length**

straight

252-031-120

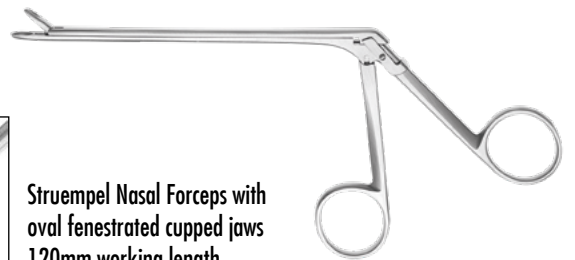

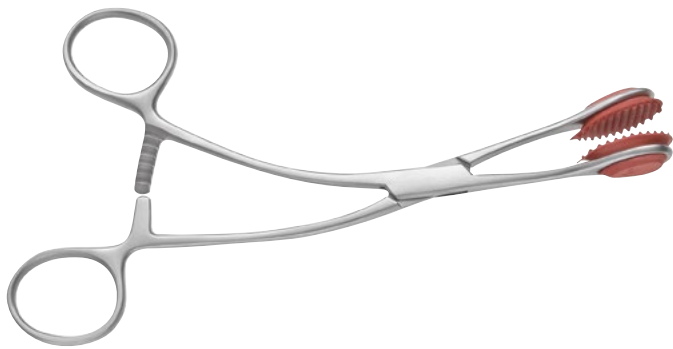

Young Tongue Holding Forceps

170mm

430-467-170



Hurd Elevator

230mm

430-522-230



Green Retractor, 20 x 23mm

220mm

170-319-220



Lange Choana Hook

230mm

420-413-230



Laryngeal mirror with hexagonal handle, 180mm

Fig. 00, Ø8mm	230-330-008
Fig. 1, Ø12mm	230-330-012
Fig. 3, Ø16mm	230-330-016
Fig. 5, Ø20mm	230-330-020

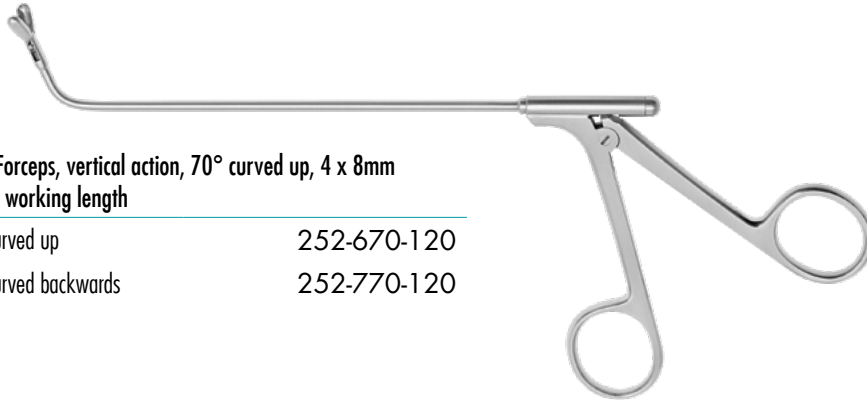

**Biopsy Forceps, vertical action, 70° curved up, 4 x 8mm
130mm working length**

70° curved up	252-670-120
110° curved backwards	252-770-120





Bronchoscopy/ Esophago-Gastroscopy

Instruments and rigid scopes for the respiratory
and gastrointestinal area



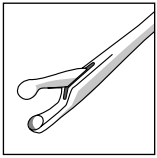
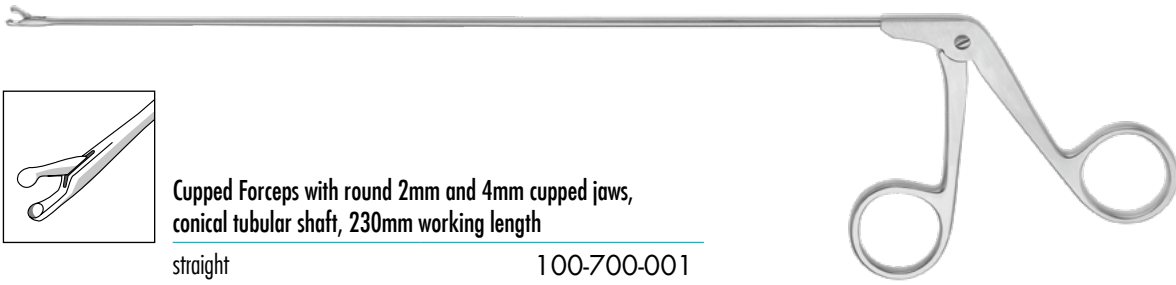

Cupped Forceps with round 2mm and 4mm cupped jaws, conical tubular shaft, 230mm working length

straight 100-700-001

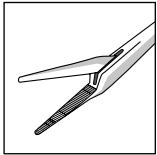

Alligator Forceps, standard model, conical tubular shaft 2mm, 230mm working length

straight, serrated 100-700-020

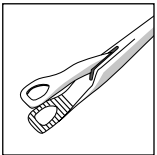

Alligator Forceps, standard model, conical tubular shaft 2mm, triangular jaws, 230mm working length

straight 100-700-026

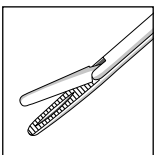
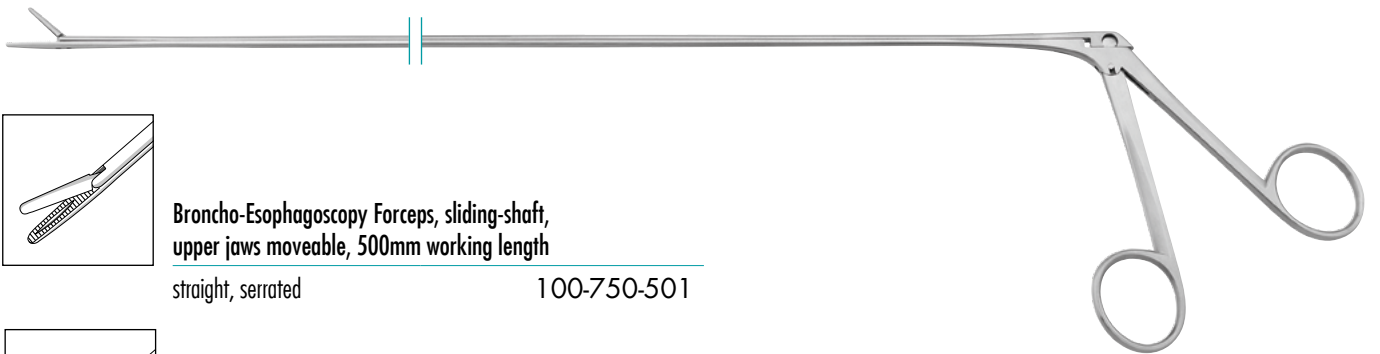

Broncho-Esophagoscopy Forceps, sliding-shaft, upper jaws moveable, 500mm working length

straight, serrated 100-750-501

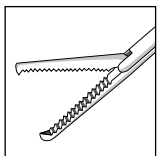

straight, 1x2 teeth 100-750-502

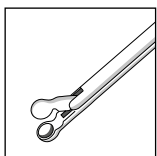

straight, cupped jaws 100-750-504

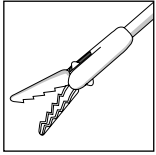
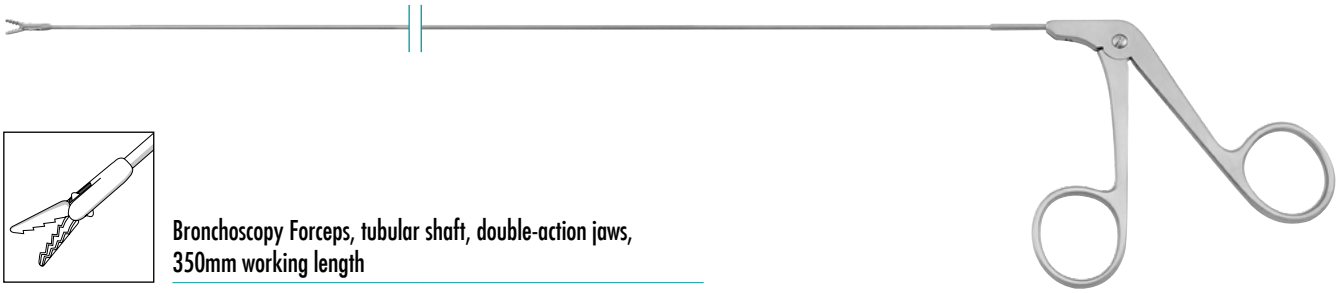

**Bronchoscopy Forceps, tubular shaft, double-action jaws,
350mm working length**

Alligator jaw

100-720-021

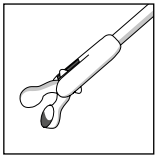

**Bronchoscopy Forceps, tubular shaft, double-action jaws,
biopsy cup, 350mm working length**

straight, round cup

100-720-023



Bronchoscope, rigid, 540mm working length, 30°

Ø 5.5mm

100-655-100

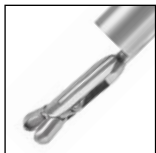
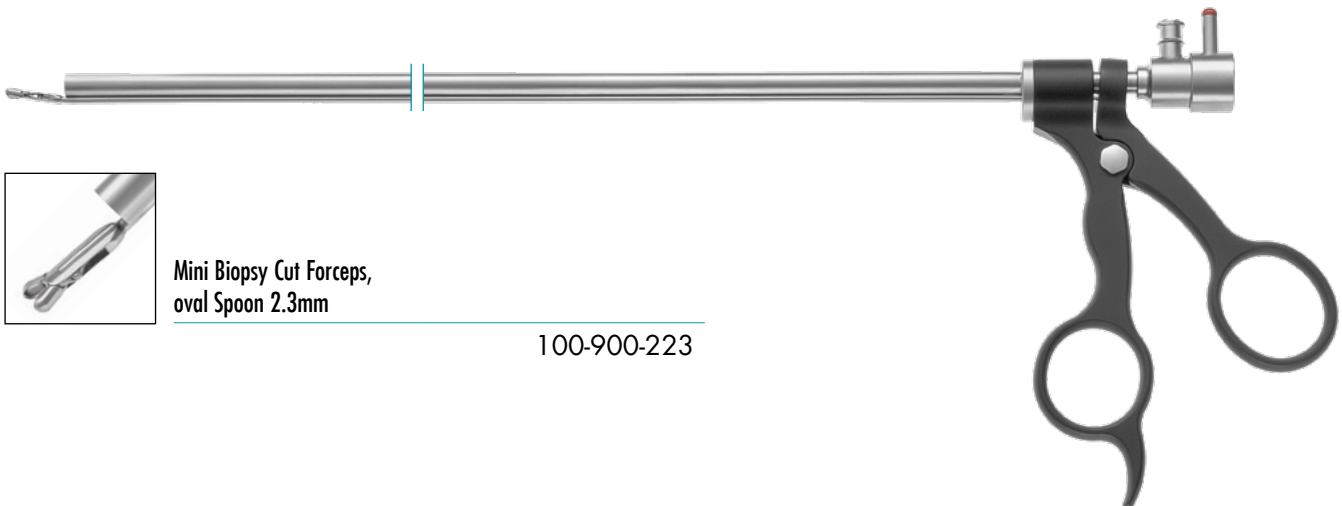

**Mini Biopsy Cut Forceps,
oval Spoon 2.3mm**

100-900-223



Bronchoscope, rigid, 300mm working length, 0°
 Ø 2.9mm 100-629-000

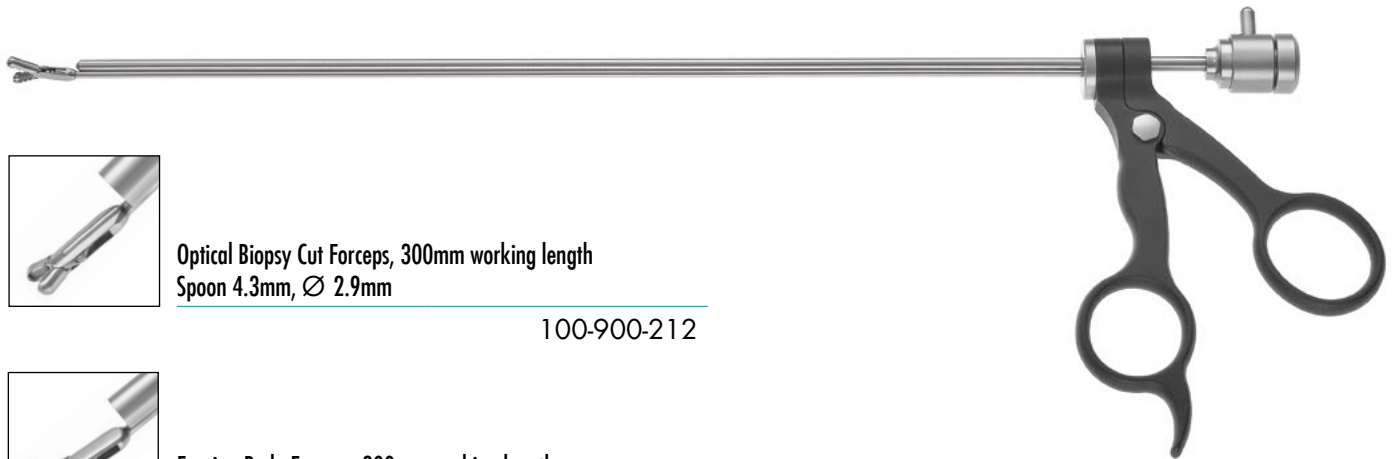

Optical Biopsy Cut Forceps, 300mm working length
 Spoon 4.3mm, Ø 2.9mm
 100-900-212



Foreign Body Forceps, 300mm working length
 for Bronchoscope 100-629-000
 100-900-217



Suction Tube, 250mm working length
 Ø 2.5mm 100-860-025



Suction Tube, with flexible rubber tip
 350mm 100-852-350
 500mm 100-852-500



VERSATIP Detachable, 360° rotatable Instruments

- ▼ Detachable – one handle for all inserts
- ▼ Color code – the easy identification of the tip
- ▼ Two handles – self holding and standard
- ▼ The easy connection – the reliable ball tip technique
- ▼ Light weight handle – the perfect fit for your fingers
- ▼ Make cleaning easy – flushing port for the complete instrument
- ▼ 360° rotation - just with your finger tip
- ▼ All parts can be ordered separately



PATENTED
10 2022 107 371.8



Color coded inserts

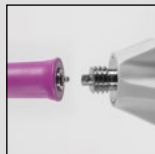

Unique, detachable system



Flushing port for easy cleaning



Two handles - multiple options

Forceps & punches

- Automatic self-holding
- Black color coded

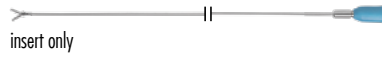

351-100-500
Self-holding handle for
forceps and punches
(recommended handle)



**Grasping Forceps with toothed cup,
rigid, double action**

insert only	351-116-535
complete instrument	351-116-335



**Tenaculum Forceps, 1x1 teeth,
semi-rigid, double action**

insert only	351-117-535
complete instrument	351-117-335



**SHARK Tenaculum Grasping Forceps,
semi-rigid, double action**

insert only	351-115-535
complete instrument	351-115-335

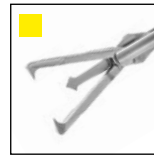

**ACCARDI Harpoon Grasping Forceps,
semi-rigid, double action**

insert only	351-119-535
complete instrument	351-119-335



**Biopsy Forceps,
rigid, double action**

insert only	351-120-535
complete instrument	351-120-335

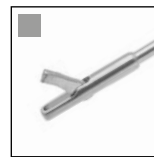

**Biopsy Punch
rigid, single action**

insert only	351-126-535
complete instrument	351-126-335

Scissors

- Standard handle
- White color coded

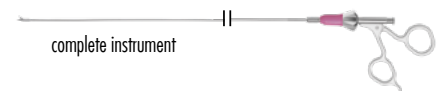

351-100-550
Standard handle
for scissors
(recommended handle)



Scissors, sharp tips, single action

insert only	351-118-535
complete instrument	351-118-335

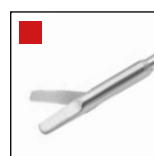

Scissors, blunt tips, rigid, single action

insert only	351-100-535
complete instrument	351-100-335



Flexible Endoscopy

VIPER Video Endoscopy System & Gastroscope

- Plug & Play - one unit for all optics
- Bright LED light
- Up to 210° angulation
- 140° wide angle



VIPER Video Endoscopy System



VIPER Endoscopy System
consisting of: Main Unit, White Balance Hood,
USB Flash drive

310-800-300



White Balance Hood
included

Delivery contains:

- Main Unit
- White Balance Hood
- USB Flash Drive
- Mains Cable, IFU, Fuse

VIPER Gastroscope



Gastroscope

Working length	Diameter	Working Channel	
3500mm	12.8mm	3.7mm	310-800-301
1500mm	8.0mm	2.8mm	310-800-302
1000mm	6.0mm	2.0mm	310-800-303
Bronchoscope			
600mm	5.8mm	2.8mm	310-800-304
600mm	3.5mm	1.2mm	310-800-305

Delivery contains:

- Endoscope
- Flushing Bottle
- Pressure Meter
- Cleaning Hose
- Cleaning Accessories
- Connection Cables
- Carry Bag
- IFU



Accessories for flexible endoscopes



FLEXIBLE



3 prongs Grasper, 600mm working length

∅ 1.6mm	253-940-005
∅ 1.0mm	253-940-003



Foreign Body Retriever, 2x2 teeth

∅ 1.8mm, 2300mm working length	310-970-230
∅ 2.3mm, 2300mm working length	310-971-230

2x1 teeth

∅ 2.3mm, 2300mm working length	310-973-230
∅ 1.8mm, 1800mm working length	310-972-180



3 prongs Retriever, round

∅ 1.8mm, 1800mm working length	310-981-180
∅ 2.3mm, 1800mm working length	310-982-180
∅ 2.3mm, 2300mm working length	310-982-230



4 prongs Retriever, sharp

∅ 2.3mm, 2300mm working length	310-983-230
--------------------------------	-------------





Long Oval Cup, serrated

∅ 1.0mm, 1200mm WL	310-935-100
∅ 1.8mm, 1200mm WL	310-935-120
∅ 1.8mm, 1800mm WL	310-935-180
∅ 2.3mm, 2300mm WL	310-937-230



Long Oval Cup, fenestrated

∅ 1.0mm, 1200mm WL	310-901-120
∅ 1.8mm, 1800mm WL	310-904-180
∅ 2.3mm, 2300mm WL	310-906-230



Biopsy Forceps, oval cup with fine teeth

∅ 1.8mm, 1800mm WL	310-944-180
∅ 2.3mm, 2300mm WL	310-945-230



Long Oval Cup, fenestrated, with needle

∅ 1.8mm, 1600mm WL	310-907-160
∅ 2.3mm, 2300mm WL	310-909-230



Alligator Forceps

∅ 1.0mm, 1200mm WL	310-960-120
∅ 1.6mm, 1600mm WL	310-962-160
∅ 1.8mm, 1800mm WL	310-963-180
∅ 2.3mm, 2300mm WL	310-964-230



Round Cup, fenestrated

∅ 1.8mm, 2300mm WL	310-930-230
∅ 2.5mm, 1500mm WL	310-929-180



Rat Tooth, 2x1 teeth

∅ 1.8mm, 1800mm WL	310-952-180
∅ 2.3mm, 2300mm WL	310-953-230



Dormia Metal Stone Basket

7 Charr., 2.3mm / 2300mm WL	253-585-237
5 Charr., 1.6mm / 1800mm WL	253-585-185
5 Charr., 1.6mm / 600mm WL	253-585-005
3 Charr., 1.0mm / 600mm WL	253-585-003

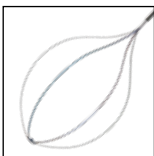
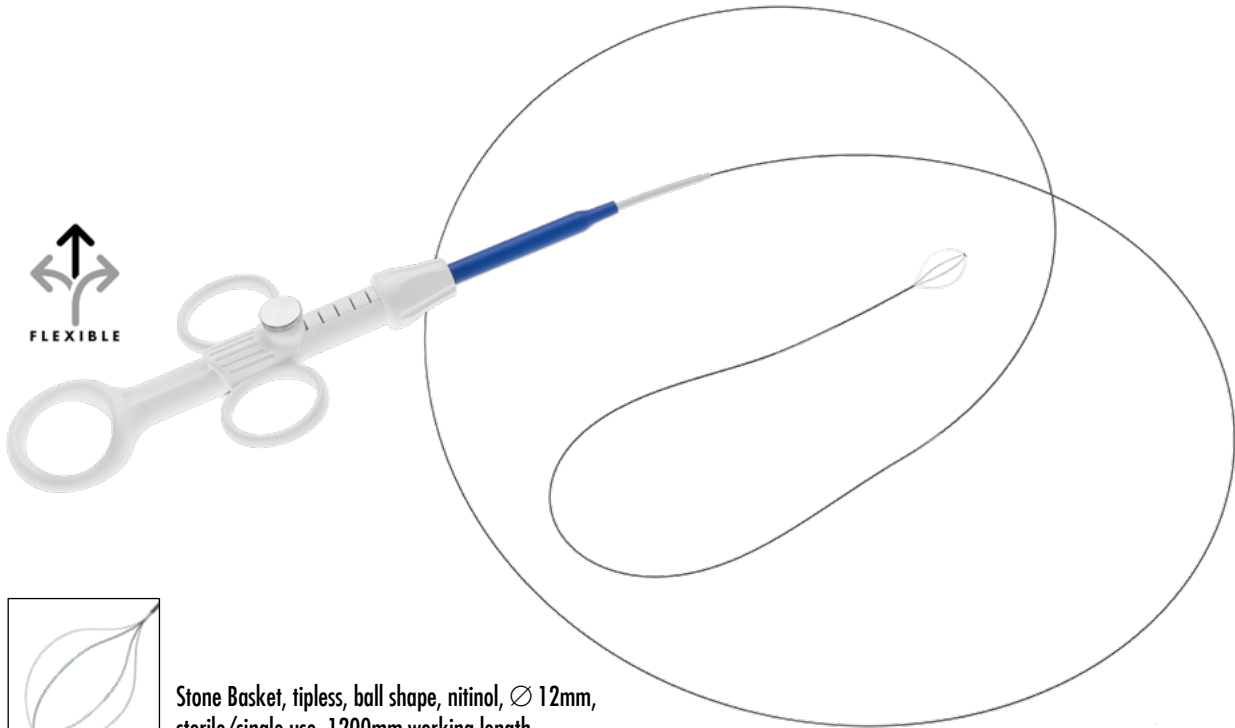

Stone Basket, tipless, ball shape, nitinol, Ø 12mm, sterile/single use, 1200mm working length

1.3 Charr.	253-960-013
1.9 Charr.	253-960-019

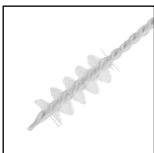

Brush for Cystology, 3.0 Charr., single use, package of 5 pieces

3.0 Charr.	253-962-003
------------	-------------

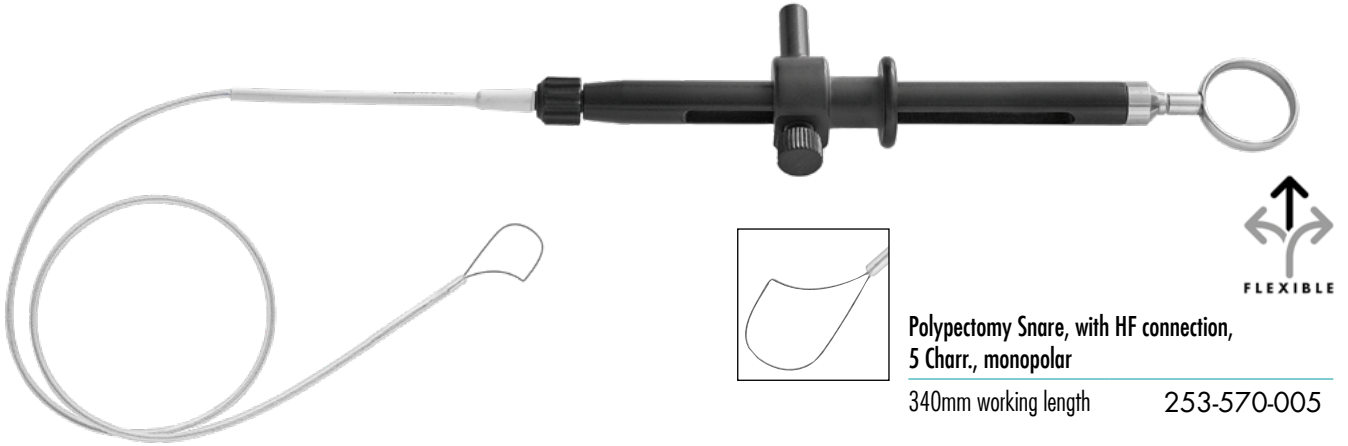

**Polypectomy Snare, with HF connection,
5 Charr., monopolar**

340mm working length 253-570-005

FLEXIBLE

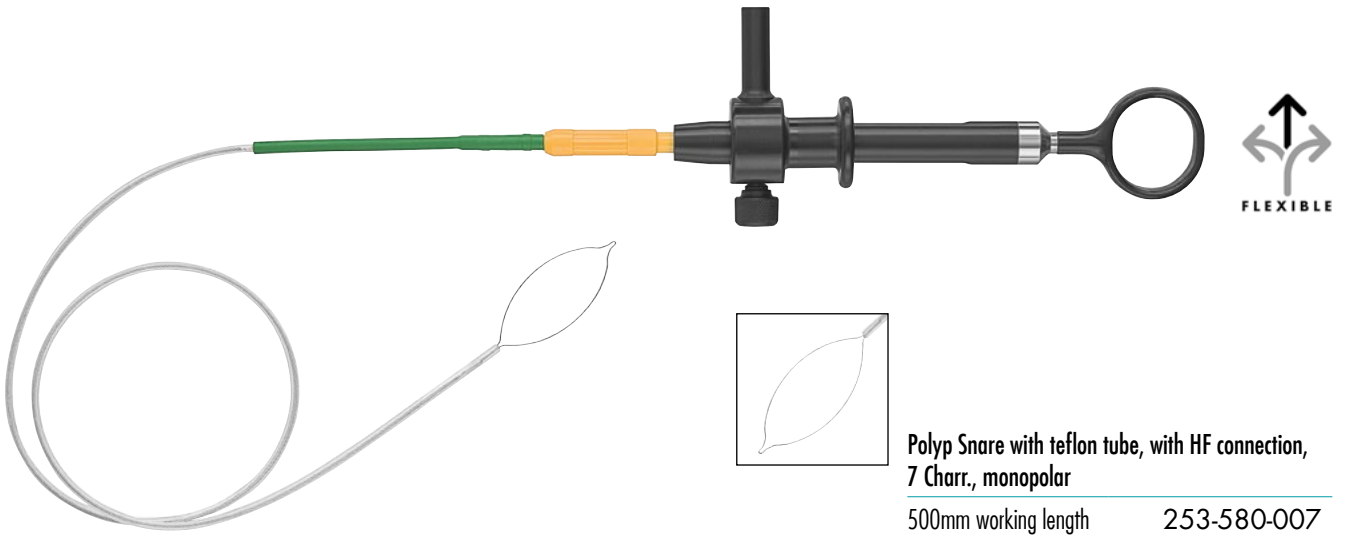

**Polyp Snare with teflon tube, with HF connection,
7 Charr., monopolar**

500mm working length 253-580-007

FLEXIBLE

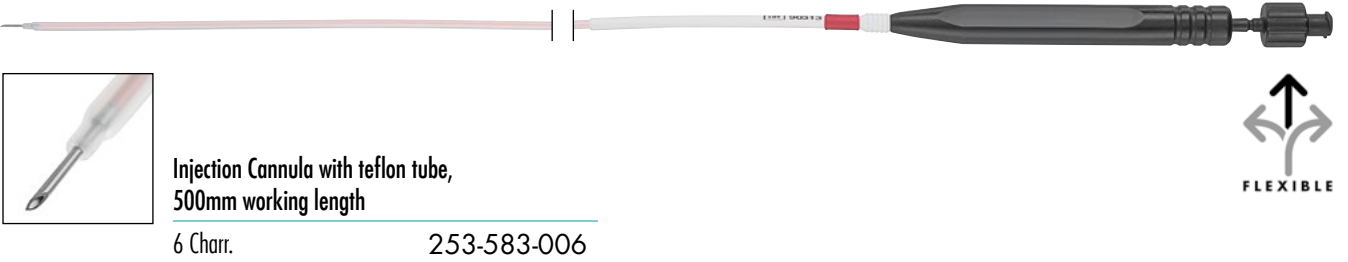

**Injection Cannula with teflon tube,
500mm working length**

6 Charr. 253-583-006

FLEXIBLE

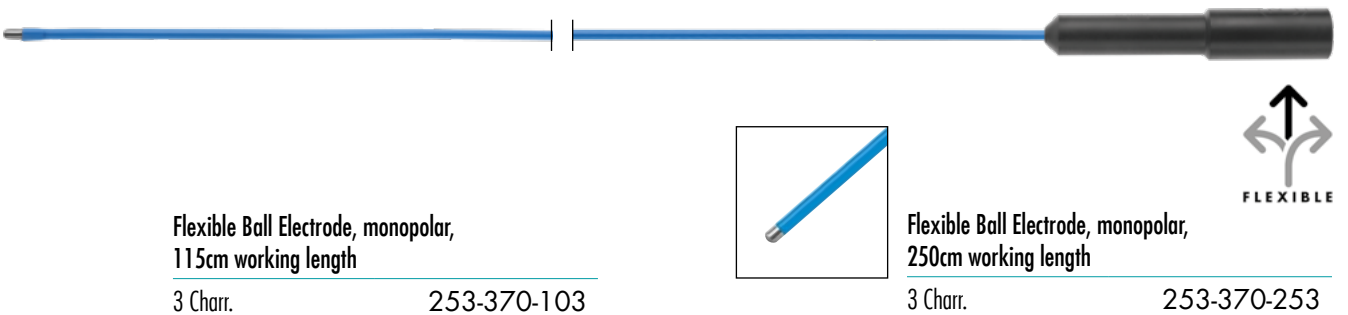

**Flexible Ball Electrode, monopolar,
115cm working length**

3 Charr. 253-370-103

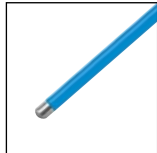

**Flexible Ball Electrode, monopolar,
250cm working length**

3 Charr. 253-370-253

FLEXIBLE

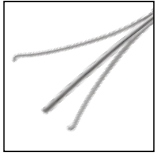

Stone Grasping Forceps, rigid, 400mm working length, triple toothed jaw, U-spring handle

5 Charr.

253-960-360



Stone Grasping Forceps with spring handle and finger platform, Ø 4mm, Luer-Lock connection fenestrated jaws

360mm

253-900-205

450mm

253-900-245



Stone Grasping Forceps with spring handle and finger platform, Ø 4mm, Luer-Lock connection, 3 prongs

360mm

253-900-206

450mm

253-900-246

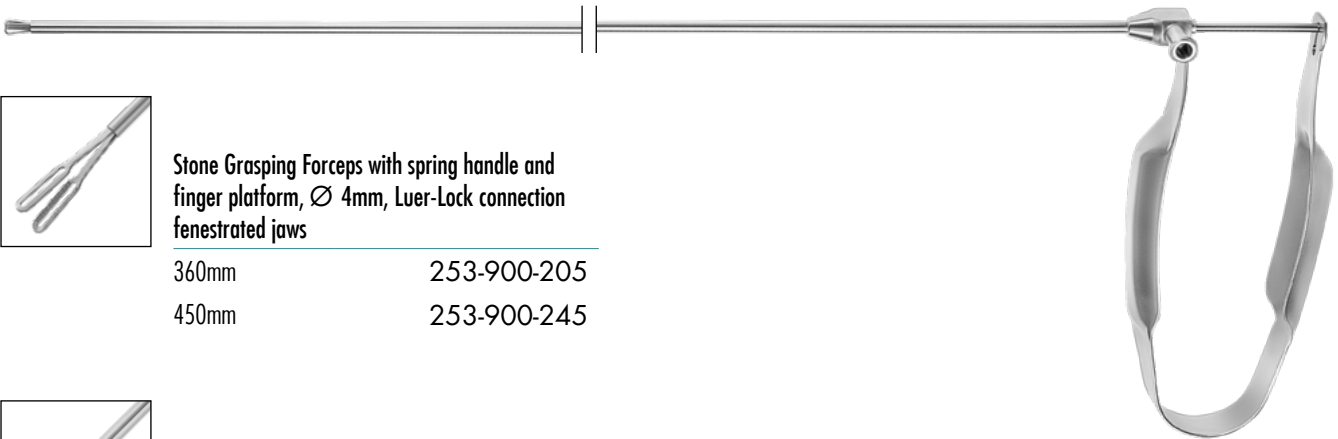

Urology/Vaginoscopy
Hysteroscopy





SMALL

Ø2.0mm

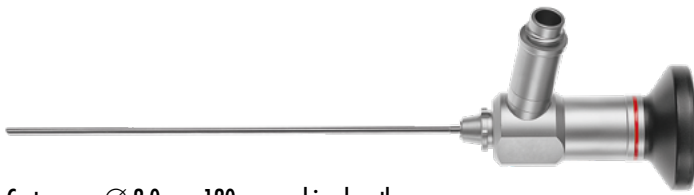

Cystoscope, Ø 2.0mm, 120mm working length

0°	253-221-000
30°	253-221-030

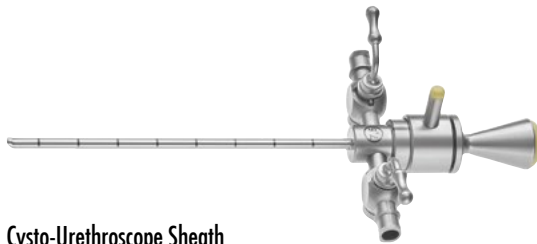

Cysto-Urethroscope Sheath

7.5 Charr.	253-200-007
------------	-------------

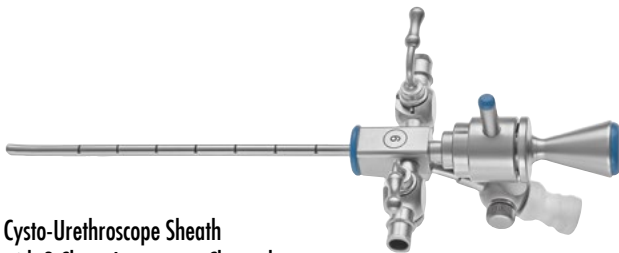

Cysto-Urethroscope Sheath
with 3 Charr. Instrument Channel

9 Charr.	253-200-009
----------	-------------



LARGE

Ø2.7mm



Cystoscope, Ø 2.7mm, 187mm working length

0°	253-227-000
30°	253-227-030

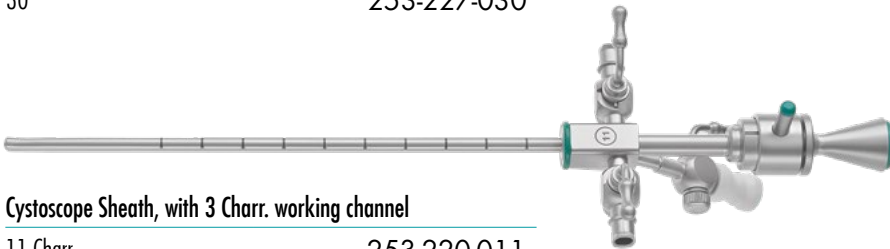

Cystoscope Sheath, with 3 Charr. working channel

11 Charr.	253-220-011
-----------	-------------

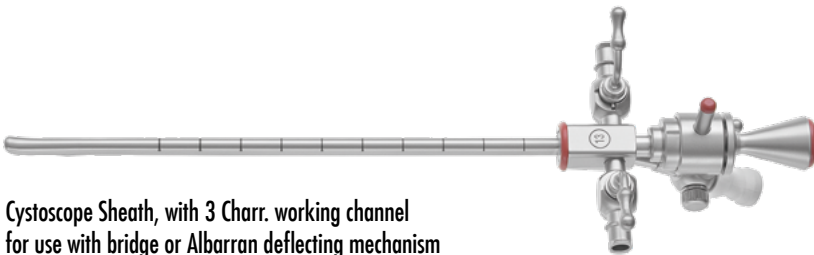

**Cystoscope Sheath, with 3 Charr. working channel
for use with bridge or Albarran deflecting mechanism**

13 Charr.	253-220-014
-----------	-------------



Albarran deflecting mechanism

for use with 253-220-014	253-220-025
for use with 3 Charr. Instruments	253-202-003 + 253-204-003

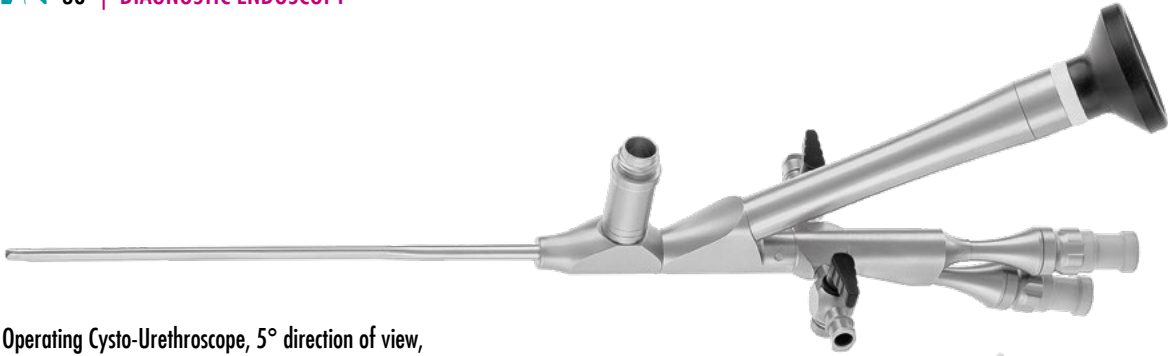

**Operating Cysto-Urethroscope, 5° direction of view,
2 lateral suction/irrigation connections, 140mm working length**

6.0 Charr. / 5.0 Charr. working channel 253-200-600

4.5 Charr. / 3.5 Charr. working channel 253-200-500



Silicone Valve

pack of 5 pcs.

253-905-400



Sinuscope, Ø 2.7mm, 180mm working length

30° 252-127-030

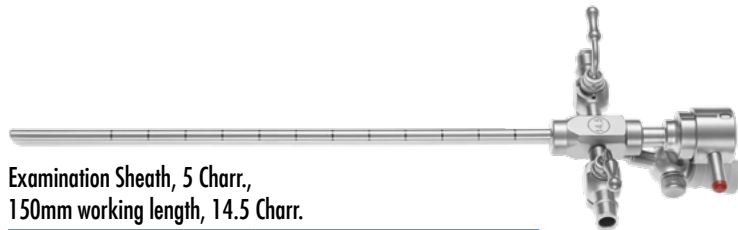

**Examination Sheath, 5 Charr.,
150mm working length, 14.5 Charr.**

for 30° telescope 252-027-185

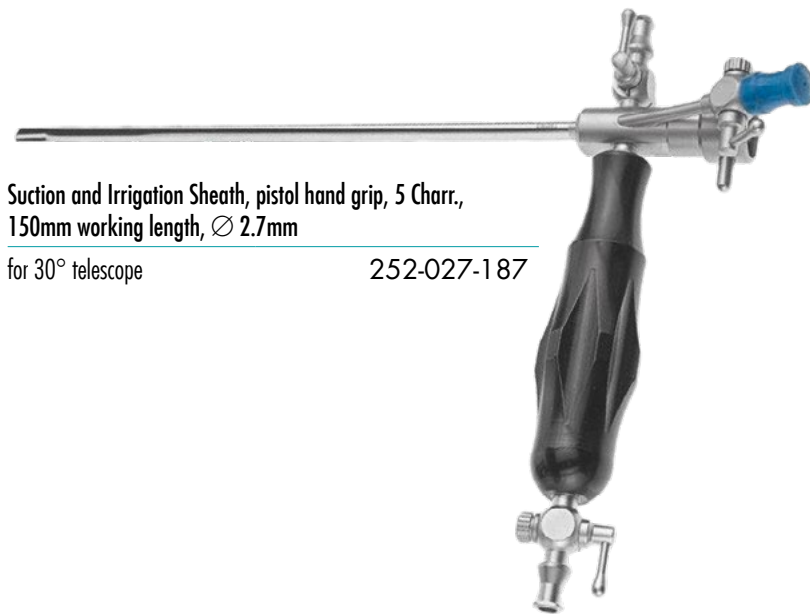

**Suction and Irrigation Sheath, pistol hand grip, 5 Charr.,
150mm working length, Ø 2.7mm**

for 30° telescope 252-027-187

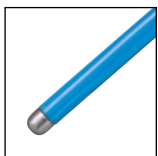

Ball Electrode, monopolar, 530mm length

5 Charr.

253-370-005

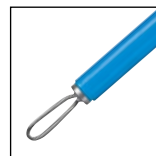

Loop Electrode, monopolar, 530mm length

5 Charr.

253-372-005





Killian Specula, 145mm

36 x 7mm	420-145-036
75 x 7mm	420-145-075



Cottle Specula with set-screw, 135mm

38mm	420-136-035
70mm	420-136-070



St. Clair Thompson Specula, 73mm

38mm	420-052-001
65mm	420-002-003



Artificial Insemination



Advanced Semi-Rigid Uretero-Renoscope

425mm working length 253-905-540

Distal tip	7.0 Charr.
Distal	8.0 Charr.
Proximal	9.5 Charr.
Working channel <small>(for use with instruments up to 5 Charr.)</small>	5.8 Charr.
Field of view	65°
Direction of View	5°

slim LINE



Advanced Semi-Rigid Uretero-Renoscope

425mm working length 253-910-540

Distal tip	6.0 Charr.
Distal	7.0 Charr.
Proximal	7.5 Charr.
Working channel <small>(for use with instruments up to 4 Charr.)</small>	5.0 Charr.
Field of view	65°
Direction of View	5°

Transurethral injection



Cystoscope, Ø 4.0mm, 300mm working length
 12° 253-804-012



Passive Titanium Working element
 for 253-804-012 253-000-312

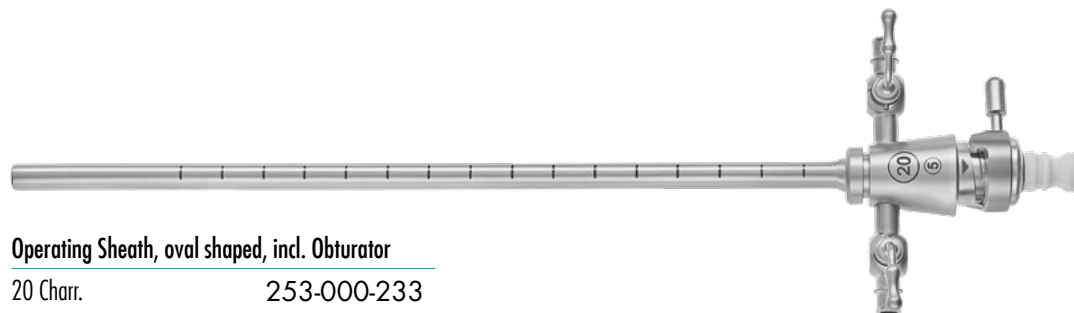

Operating Sheath, oval shaped, incl. Obturator
 20 Charr. 253-000-233



**Injection Cannula, semi-rigid, 2 Charr. distal end
 with rotatable Luer-Lock Adapter**
 4 Charr. 253-000-235

Exotic Animals

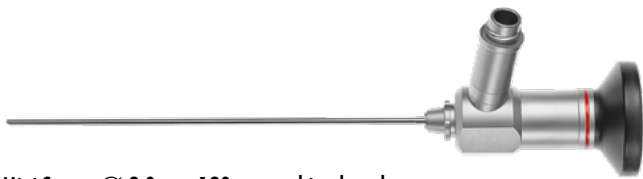
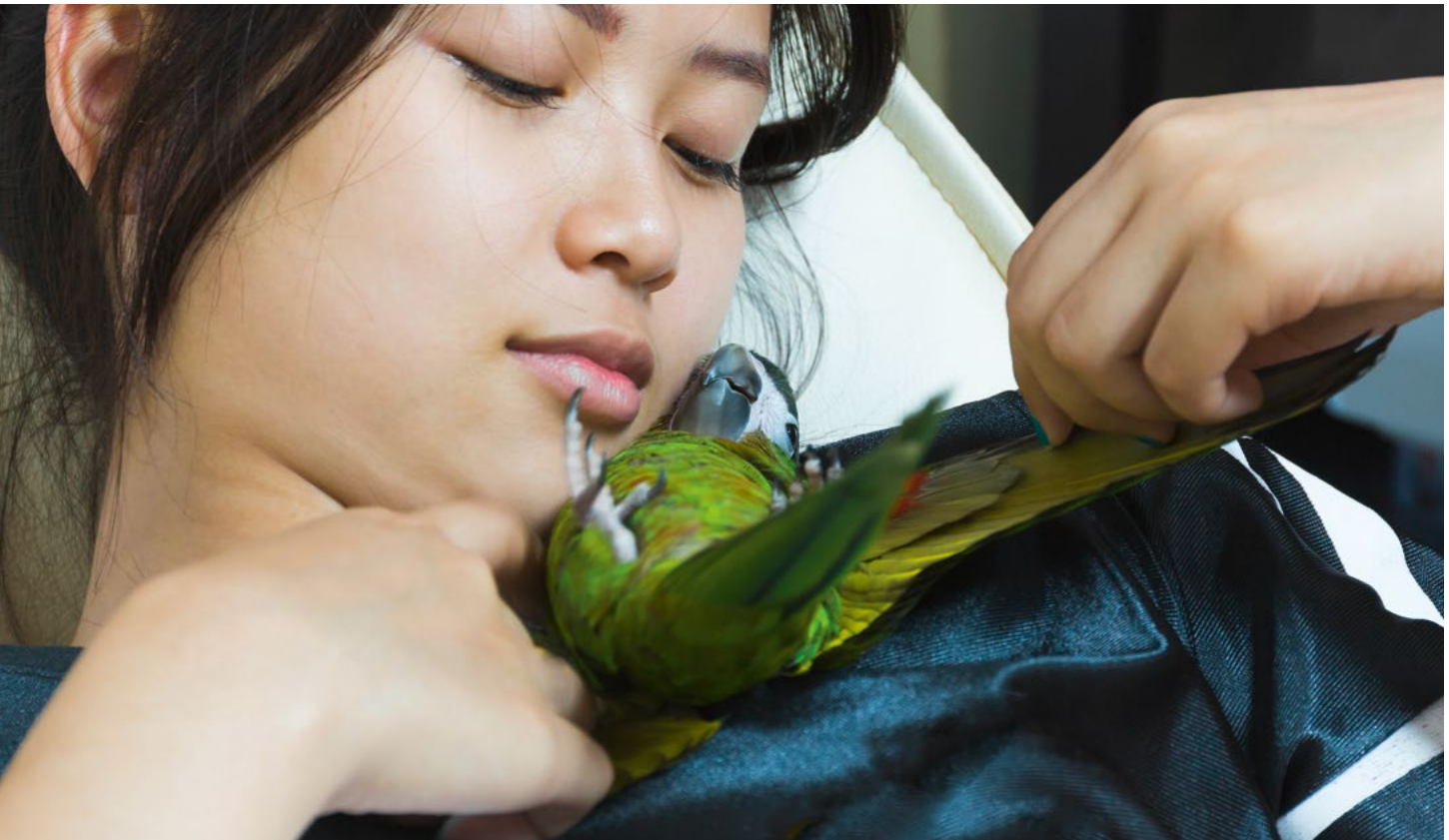

Mini Scope, \varnothing 2.0mm, 120mm working length

0° 253-221-000
30° 253-221-030



LED Portable Lightsource, with 1700mAh charger

300-001-183

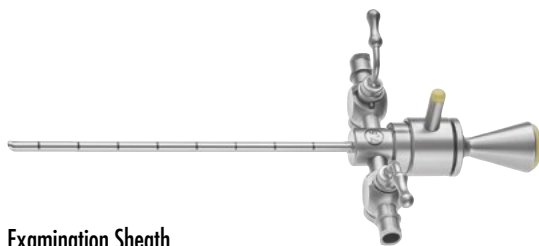

Examination Sheath

7.5 Charr. 253-200-007

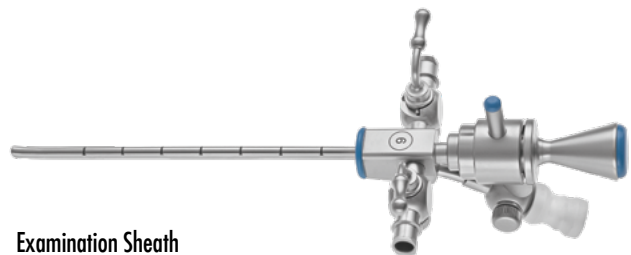

Examination Sheath
with 3 Charr. instrument channel

9 Charr. 253-200-009



Cystoscope, \varnothing 2.0mm, 187.5mm working length

0°	253-219-100
30°	253-219-130



Cystoscope Sheath

7.5 Charr.	253-200-075
------------	-------------

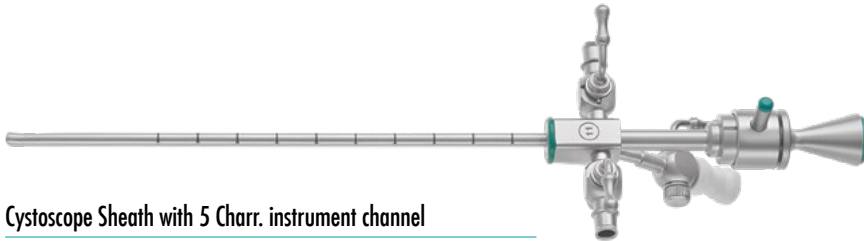

Cystoscope Sheath with 5 Charr. instrument channel

11 Charr.	253-200-011
-----------	-------------



Sinuscope, \varnothing 2.7mm, 180mm working length

0°	252-127-000
30°	252-127-030
70°	252-127-070

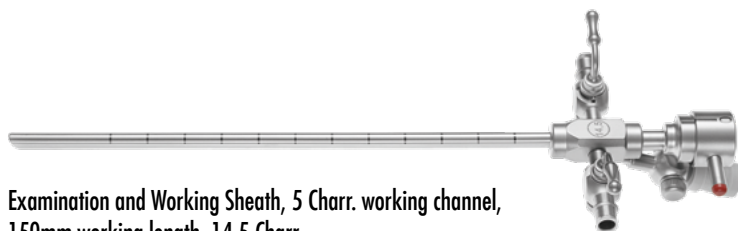

Examination and Working Sheath, 5 Charr. working channel, 150mm working length, 14.5 Charr.

for \varnothing 2.7mm telescopes	252-027-185
------------------------------------	-------------

arthroscopy.





ArthVIEW®

- Full HD scopes for your image
- Color code indicates direction of view
- High durable sapphire glass tip
- Optimized glass fiber arrangements for uniform brightness
- Fully autoclavable

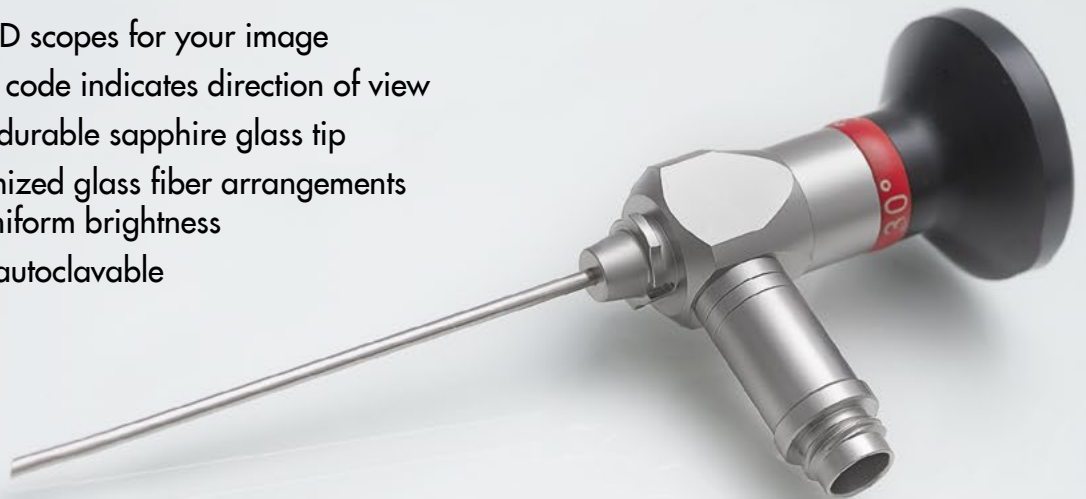

ArthFLOW®

- The perfect match for your scopes
- 360° rotatable stopcocks
- Color coded
- Easy to clean and maintain
- Available in regular and high flow





Arthroscopy Set according to Dr. Scharvogel

Diplomate ECVS

225-999-001

Arthroscopy Set according

Dr. Stefan Scharvogel

Diplomate ECVS (European Specialist in Small Animal Surgery)

Specialist for surgery, specialist for small animals

Arthroscopy has become the standard for diagnosis and treatment of joint diseases in small animal clinic. Modern visualization techniques and dedicated instruments help to visualize anatomical structures and treat pathologies minimally invasive with an accelerating recovery.

This Arthroscopy Set has been configured by Dr. Stefan Scharvogel and is based on his experience and knowledge of many years as a veterinary surgeon.

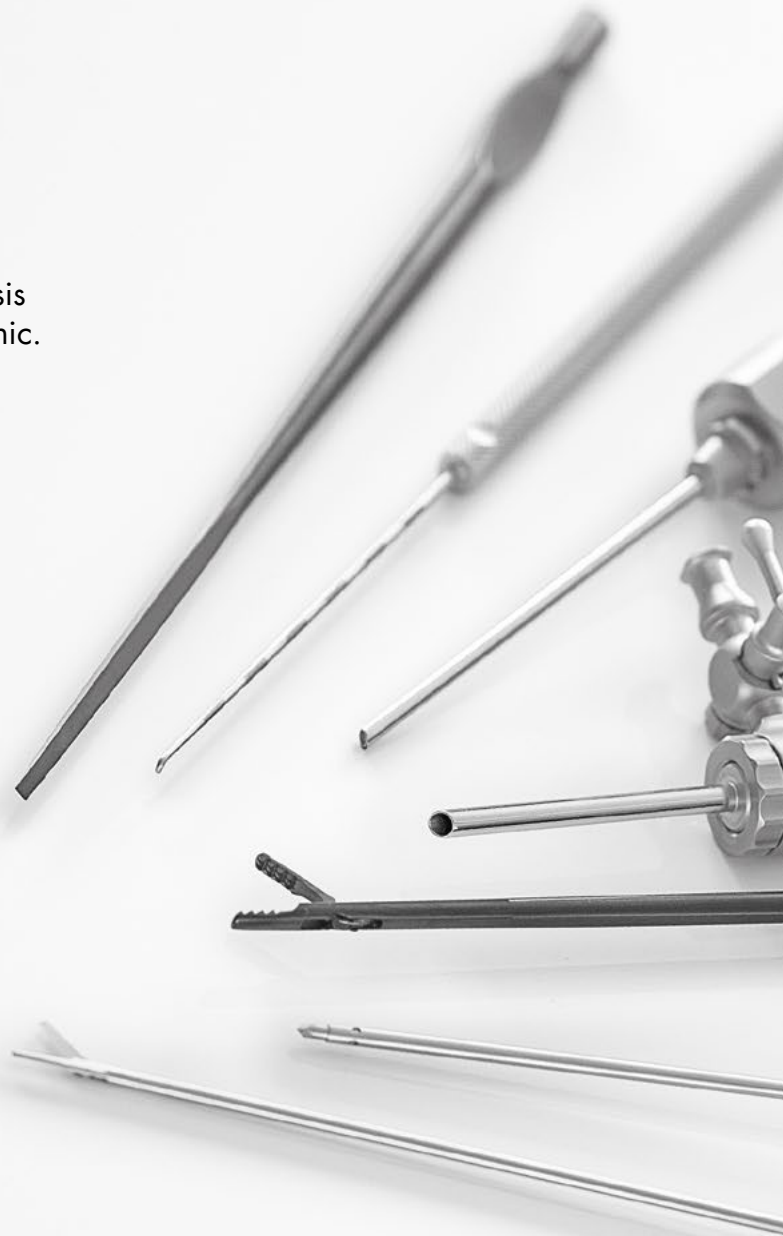



Arthroscopy Set according to Dr. Scharvogel

Diplomate ECVS

225-999-001

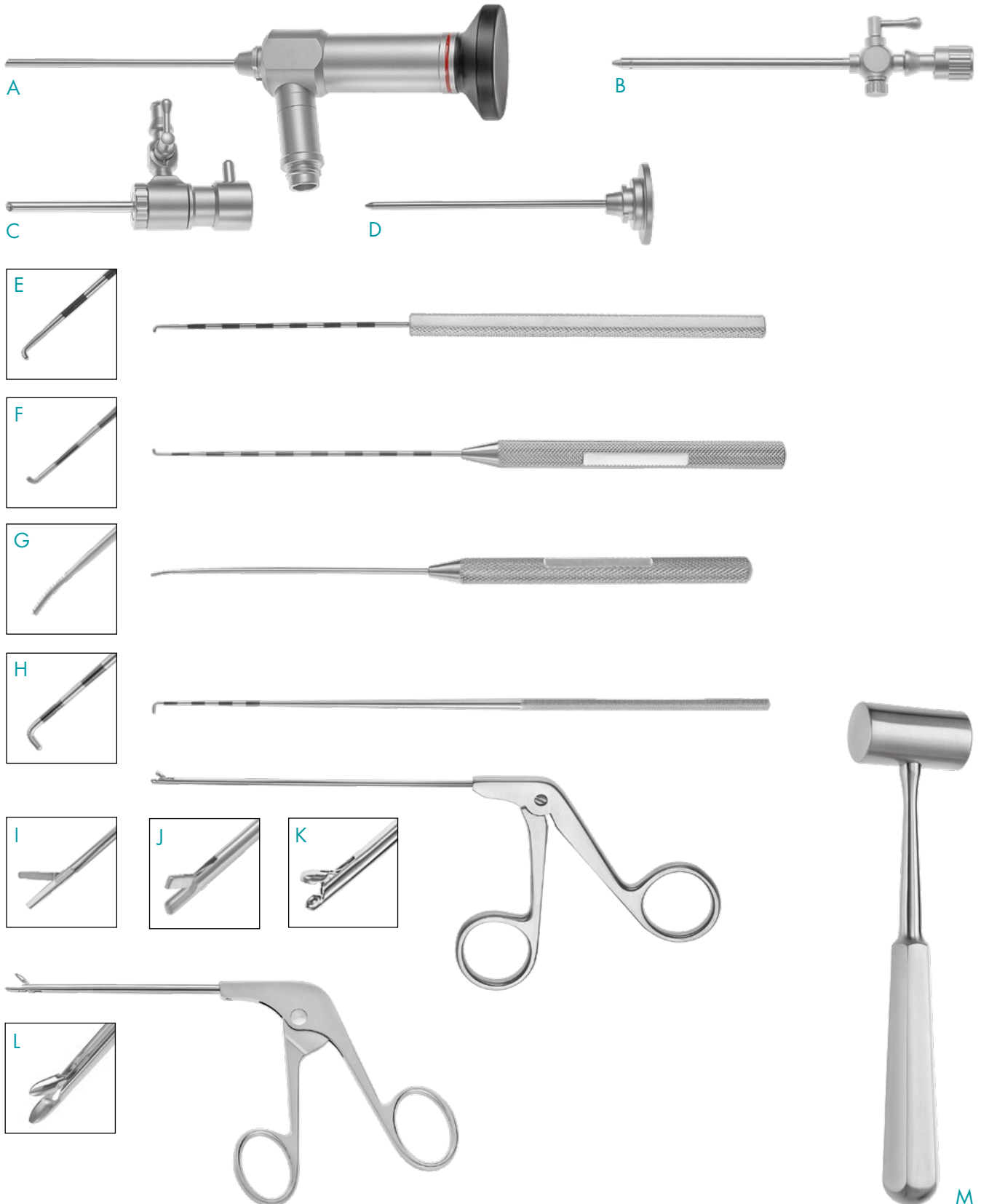



A	ArthView® Mini Arthroscope, \varnothing 2.4mm, 69mm working length	225-124-030
B	Irrigation Cannula Set incl. trocar and obturator, 70mm, \varnothing 2.3mm	225-850-000
C	ArthFlow® Sheath	225-512-332
D	ArthFlow® Obturator, for \varnothing 3.2mm operating sheath	225-512-532
E	Probe Hook, graduated, 75mm working length	225-100-115
F	Exploring Probe, 4mm, graduated	225-090-002
G	Mini Rasp, concave jaw, 90mm working length	225-090-004
H	Exploring Probe, 90° angled, Tip \varnothing 1.0 mm, graduated, 130mm working length	225-100-004
I	Mini Scissors, upwards cutting, \varnothing 2.0mm, 130mm working length	225-310-020
J	Mini Punch, \varnothing 2.0mm, 130mm working length	225-305-020
K	Mini Cupped Forceps, \varnothing 2.0mm, 130mm working length	225-307-020
L	ArthVANCE® Mini Rongeur, straight jaw, straight shaft, 95mm working length	225-810-930
M	Partsch Mallet, 120g, \varnothing 22mm	210-225-180
N	Hook Knife, 90° angled, 4mm, 130mm working length, black	225-100-038B
O	Walter Osteotome, 2mm, 190mm working length, black	420-580-002B
P	ArthVANCE® Alligator Grasping Forceps, 2.7mm straight jaw, slide lock handle, black	225-800-825B
Q	ArthVANCE® Mini Grasping Forceps, straight jaws and shaft slide lock handle, 85mm working length, black	225-810-825B



Arthroscopy Set according to Dr. Scharvogel

Diplomate ECVS

Devices recommendation

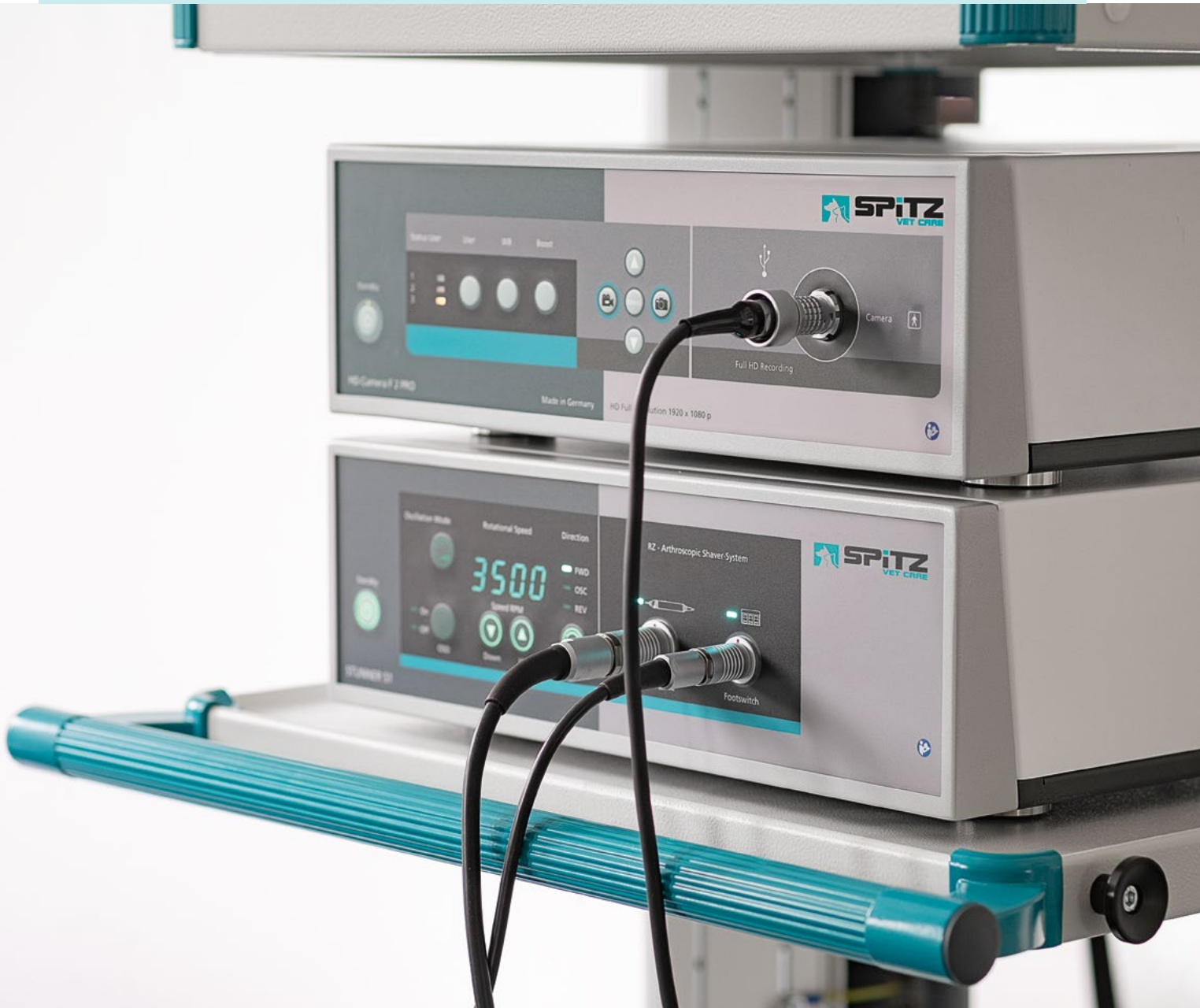

Q	P1 Arthroscopy Pump	225-906-000V
R	Stunner S1 Shaver System with Handpiece	227-001-101V + 227-001-102V
S	F2 Digital Camera System	300-001-601V
T	LUMEN LED1 Light Source	300-900-180V

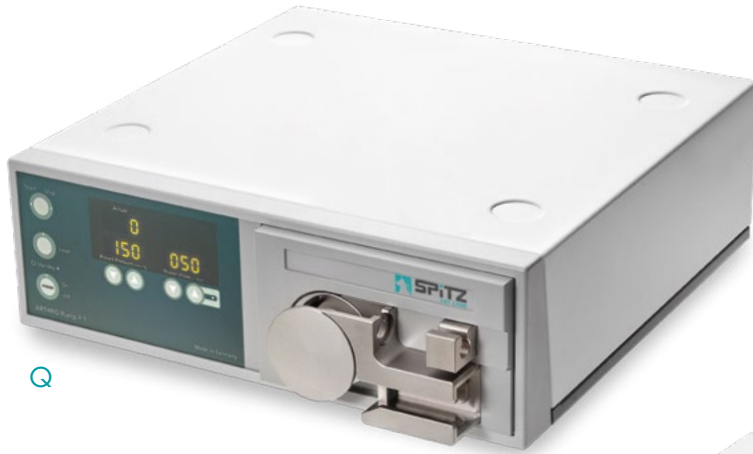

Q



R



S



T



Blax Instruments

The next step to perfection.
The Blax Instruments will give you a new experience of cutting sharpness and reliability.

- Higher corrosion resistance
- Sharpness retains longer
- Less light reflection
- High wear resistance





Hook Knife, 90° angled, 130mm working length

4mm 225-100-038B



Walter Osteotome, 190mm working length

2mm 420-580-002B



**ArthVANCE® Alligator Grasping Forceps,
slide lock handle**

2.7mm straight jaw 225-800-825B



**ArthVANCE® Mini Grasping Forceps,
slide lock handle, 85mm working length**

straight jaw /straight shaft 225-810-825B



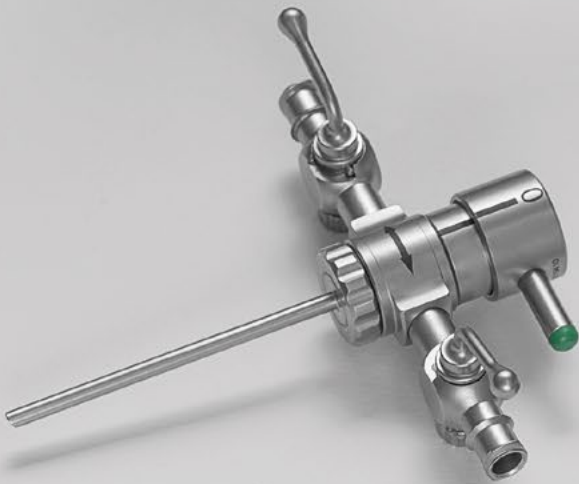

Mini Joints

Ø1.9mm

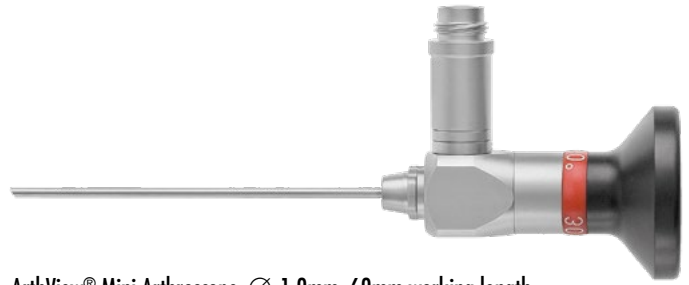

ArthView® Mini Arthroscope, Ø 1.9mm, 69mm working length

0° 225-019-000

30° 225-019-030

102mm working length

30° 225-019-130



ArthFlow® Mini Obturator / Trocar, for Ø 2.5mm operating sheath, green color code 69mm working length

blunt 225-511-525

sharp 225-511-625

for Ø 2.8mm operating sheath, blue color code 102mm working length

blunt 225-510-528

sharp 225-510-628

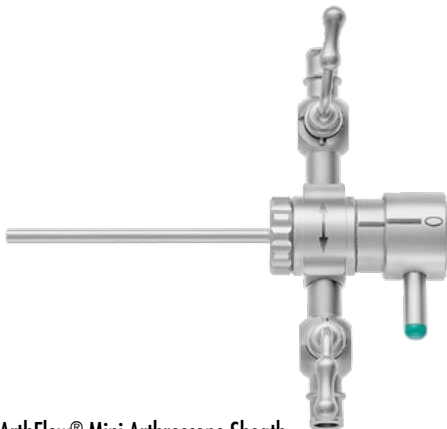

ArthFlow® Mini Arthroscopy Sheath 2 stopcocks, Ø 2.5mm, green color code, 69mm working length

for 225-019-030 (30°) 225-512-225

for 225-019-000 (0°) 225-511-225

Ø 2.8mm, 102mm working length, blue color code

for 225-019-130 (30°) 225-510-428

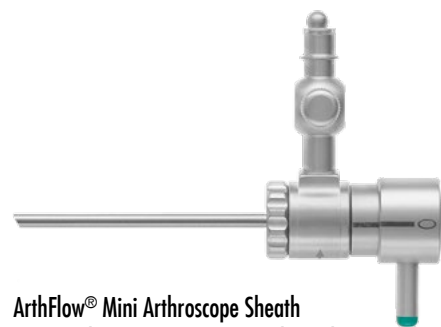

ArthFlow® Mini Arthroscopy Sheath 1 stopcock, Ø 2.5mm, green color code

for 225-019-030 (30°) 225-512-125

for 225-019-000 (0°) 225-511-125

Ø 2.8mm, 102mm working length, blue color code

for 225-019-130 (30°) 225-510-328



Small Joints

Ø2.4mm

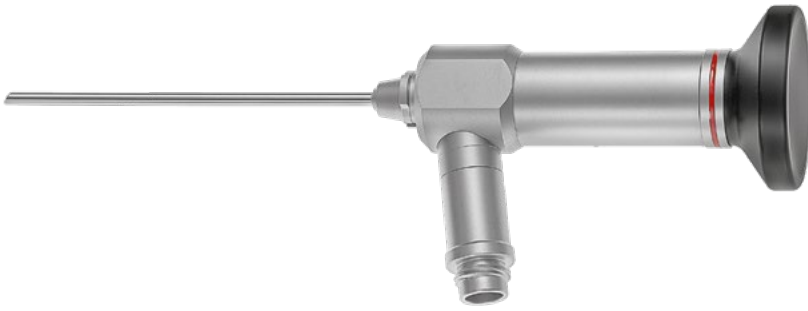

ArthView® Mini Arthroscope, Ø 2.4mm, 69mm working length

30°	225-124-030
0°	225-124-000

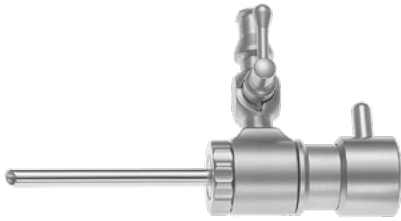

ArthFlow® Arthroscope Sheath, 1 stopcock, Ø 3.2mm

for 225-124-030 (30°)	225-512-332
for 225-124-000 / universal	225-512-232



ArthFlow® Obturator / Trocar, for Ø 3.2mm operating sheath

blunt, for 225-512-332	225-512-532
sharp, for 225-512-332	225-512-632



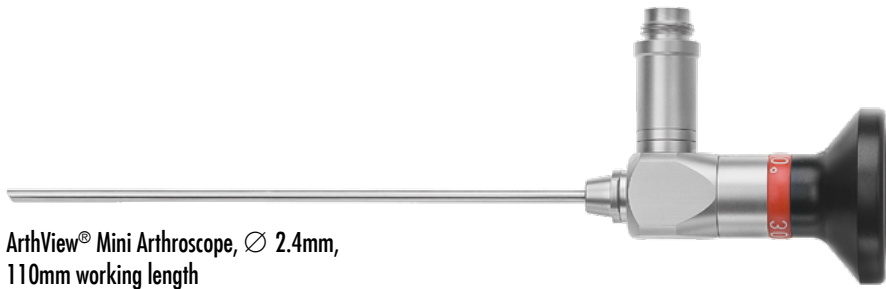

**ArthView® Mini Arthroscope, Ø 2.4mm,
110mm working length**

30°	225-224-030
0°	225-224-000
70°	225-224-070

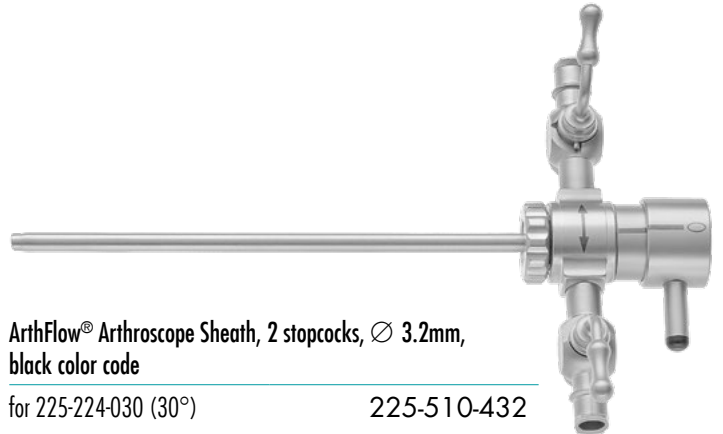

**ArthFlow® Arthroscope Sheath, 2 stopcocks, Ø 3.2mm,
black color code**

for 225-224-030 (30°)	225-510-432
for 225-224-000 (0° + 70°)	225-510-232

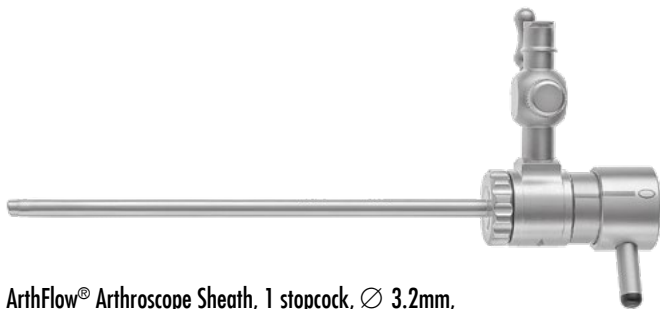

**ArthFlow® Arthroscope Sheath, 1 stopcock, Ø 3.2mm,
black color code**

for 225-224-030 (30°)	225-510-332
for 225-224-000 (0° + 70°)	225-510-132



**ArthFlow® Mini Obturator / Trocar,
for Ø 3.2mm operating sheath, black color code**

blunt	225-510-532
sharp	225-510-632



Small Joints

Ø2.7mm

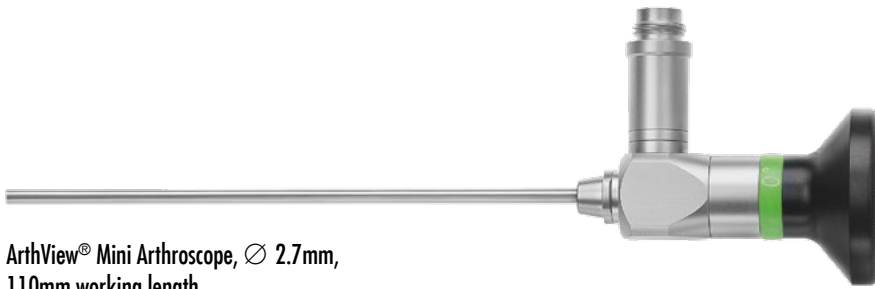

ArthView® Mini Arthroscope, Ø 2.7mm, 110mm working length

0°	225-227-000
30°	225-227-030
70°	225-227-070



ArthFlow® Mini Arthroscope Sheath 2 stopcocks, Ø 3.4mm, white color code

for 225-227-030 (30°)	225-500-434
for 225-227-000 (0° + 70°)	225-500-234



ArthFlow® Mini Arthroscope Sheath 1 stopcock, Ø 3.4mm, white color code

for 225-227-030 (30°)	225-500-334
for 225-227-000 (0° + 70°)	225-500-134



ArthFlow® Mini Obturator / Trocar, for Ø 3.4mm operating sheath, white color code

blunt	225-500-534
sharp	225-500-634



Large Joints

Ø4.0mm

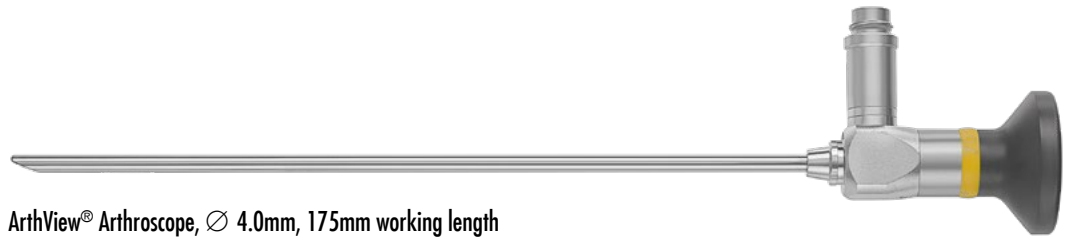

ArthView® Arthroscope, Ø 4.0mm, 175mm working length

0°	225-140-000
30°	225-140-030
45°	225-140-045
70°	225-140-070

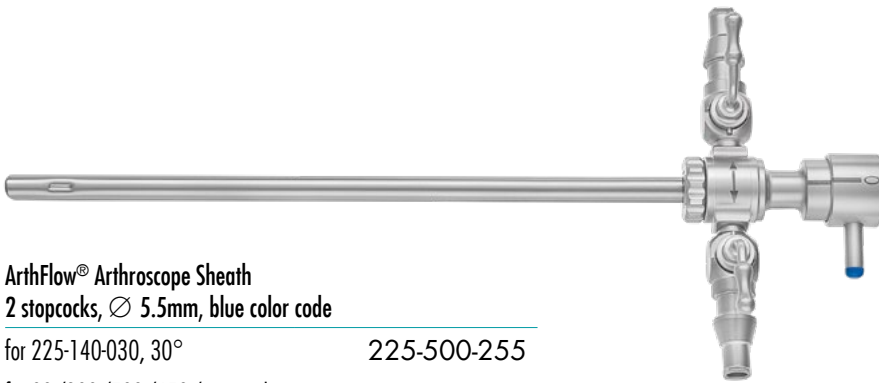

**ArthFlow® Arthroscope Sheath
2 stopcocks, Ø 5.5mm, blue color code**

for 225-140-030, 30°	225-500-255
for 0°/30°/70°/45°/universal	225-500-355

Ø 6.0mm, red color code, high flow

for 30°	225-500-260
for 0°/30°/70°/45°/universal	225-500-360



**ArthFlow® Obturator / Trocar,
for Ø 5.5mm operating sheath, blue color code**

blunt	225-500-555
sharp	225-500-655

for Ø 6.0mm operating sheath, red color code

blunt	225-500-560
sharp	225-500-660



ArthVANCE® Accessories

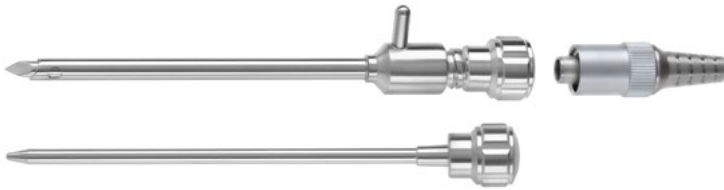

Inflow-Cannula, complete set with shaft, trocar with sharp tip, blunt obturator and irrigation adapter

Ø 4.5mm 225-850-145



Irrigation Cannula Set with 1 stopcock, including trocar and obturator, 70mm working length

Ø 2.3mm 225-850-000

Ø 3.5mm 225-850-001



Obturator, 70mm working length, blunt

Ø 2.3mm 225-850-002

Ø 3.5mm 225-850-004

Trocar, sharp

Ø 2.3mm 225-850-003

Ø 3.5mm 225-850-005



Operating Sheaths and Trocars

Cannula, 5.0mm 225-854-101

Cannula, 5.5mm 225-854-102

Cannula, 5.0mm, with valve 225-854-103

Cannula, 5.5mm, with valve 225-854-104

Trocar, sharp, 5.0mm 225-854-105

Trocar, sharp, 5.5mm 225-854-106



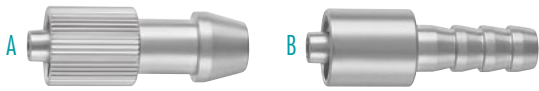

LuerLock tube connector

A 9.0mm	300-011-181
B 6.0mm	300-011-506



Scale 1:1

Sealing Cap, blue, package of 10 pcs.

∅ 5.5mm	300-023-905
---------	-------------



Guiding and changing rods for use with trocar sheath

∅ 2.7mm x 230mm	225-865-027
∅ 3.5mm x 230mm	225-865-030
∅ 4.0mm x 230mm	225-865-040



ArthVANCE[®]



Arthroscopic Instruments

Punches, Scissors and Grasping Forceps

The Arthvance Instruments provide for all joints and different anatomies the right pattern

- Low profile and small pinless jaw design allows access even to the smallest joint space
- Easy to clean with Luer-Lock connection
- Direct force transmission from your fingertip
- 100% Made in Germany



ArthVANCE® Mini Arthroscopic Instruments

Small
Joints

∅2.0mm

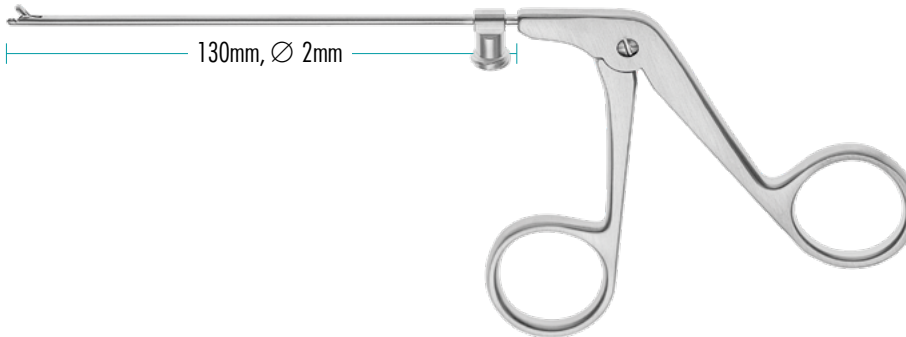

(Scale 1:1)

		Mini Punch	225-305-020
		Mini Scissors, downwards cutting	225-306-020
		Mini Cupped Forceps	225-307-020
		Mini Cupped Forceps, serrated cup	225-308-020
		Mini Grasping Forceps	225-309-020
		Mini Scissors, upwards cutting	225-310-020
		Short Mini Scissors, upwards cutting	225-311-020

ArthVANCE® Arthroscopic Punches

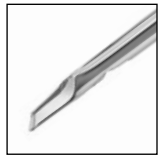
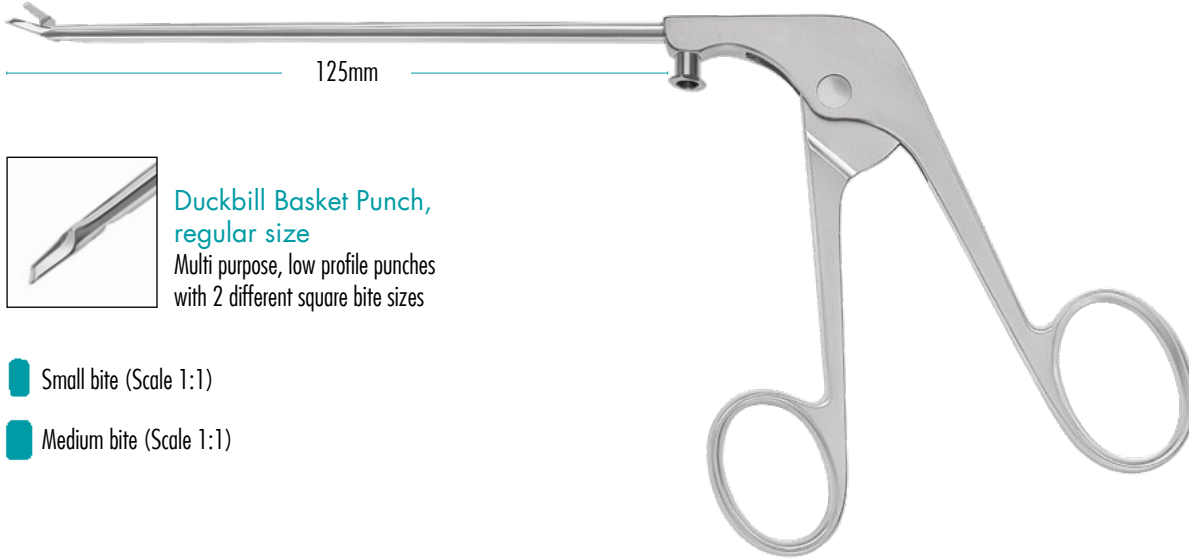

Duckbill Basket Punch, regular size
Multi purpose, low profile punches with 2 different square bite sizes

 Small bite (Scale 1:1)

 Medium bite (Scale 1:1)



Duckbill Basket Punch, ring handle, straight shaft, straight jaw

small	225-800-101
medium	225-800-102

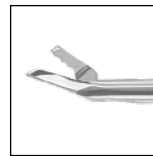

upbiter jaw

small	225-800-104
-------	-------------

left curved shaft, upbiter jaw

medium	225-800-107
--------	-------------

right curved shaft, upbiter jaw

medium	225-800-109
--------	-------------

Mini Punches

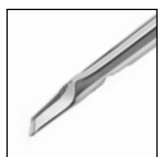
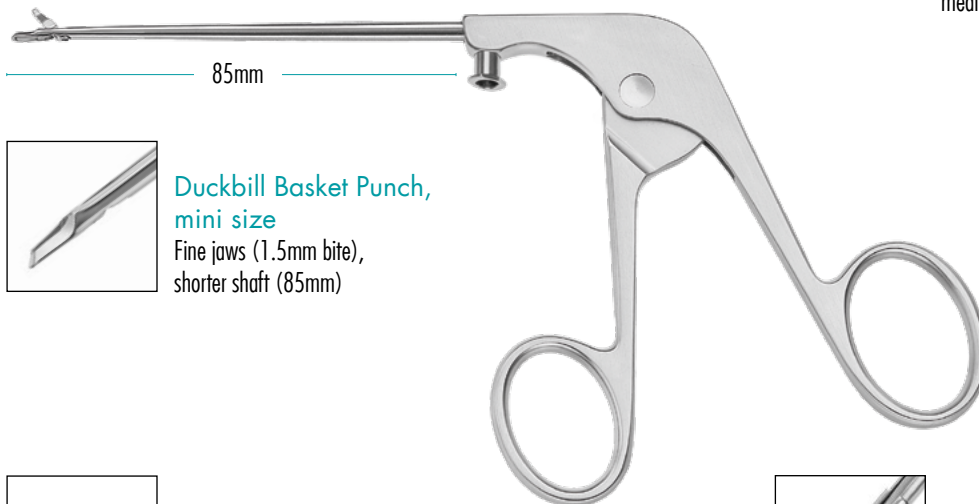

Duckbill Basket Punch, mini size
Fine jaws (1.5mm bite), shorter shaft (85mm)

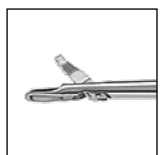

Duckbill Mini Basket Punch, ring handle, straight shaft

straight jaw	225-810-102
upbiter jaw	225-810-105
straight jaw, left curved shaft	225-810-107
straight jaw, right curved shaft	225-810-109



Rongeur, straight jaw, straight shaft, ring handle

95mm working length	225-810-930
125mm working length	225-800-920
220mm working length	225-830-920

ArthVANCE® Arthroscopic Punches

Small bite (Scale 1:1)

Medium bite (Scale 1:1)

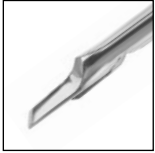

Duckling Basket Punch
Advanced Duckling low profile jaw, flat upper jaw moves completely into the lower jaw.



Duckling Elevator Basket Punch
With flat shovel for easy access.



Duckling Basket Punch, 125mm working length, straight shaft, ring handle

small	225-800-401
medium	225-800-402



Ring handle

medium	225-800-420
--------	-------------



Pro handle

medium	225-700-402
--------	-------------

Bite size (Scale 1:1)



Slimline Basket Punch
The narrow shaft and compact jaw design allows access and use in tight spaces such as the posterior aspect of the knee.



Ring handle, straight shaft, straight jaw, 125mm working length

small	225-800-002
-------	-------------



45° angled jaw

left	225-800-003
right	225-800-004



Bite size (Scale 1:1)



Backbiter
The Backbiter Basket Punch enables access to the anterior horn of the meniscus.

Ring handle, straight shaft, 125mm working length

left cutting	225-800-707
--------------	-------------

 Bite size (Scale 1:1)



Oval Punch

Offers the lowest profile and the largest bite size for end-on as well as lateral cutting. The allrounder punch.

**Ring handle, straight shaft,
125mm working length**

straight jaw 225-800-202

Mini Oval Punch, 95mm working length

straight jaw 225-810-202

left jaws 225-810-203

right jaws 225-810-204



Blunt Nose

Enables a flush contouring of the meniscus

**Ring handle, straight shaft,
85mm working length**

straight jaw 225-810-302

 Bite size (Scale 1:1)



Basket Punch SCOOP

Basket Punches are the traditional style instruments with a classical punch shape and the parrot peak upper jaw for a safe capture of tissue.

**Ring handle, straight shaft,
125mm working length**

1.0mm, straight jaw 225-800-802

1.3mm, angled jaw 225-800-805

1.3mm, downbiter jaw 225-800-806



Side Cutter

Left and Right Side Cutter punches allow easy access to anterior meniscal tears. The special designed Pencil Handle makes all Side Cutters „Rotator“ punches.

 Bite size (Scale 1:1)



**Pencil Handle, straight shaft,
85mm working length**

left side cutting 225-810-955



**Pencil Handle, straight shaft,
85mm working length**

right side cutting 225-810-957

ArthVANCE® Grasping Forceps



Shark Grasper
With blunt 1x2 teeth and serrated inner jaws.



Alligator Grasper
Short jaw with multiple serrations



Shark Grasping Forceps, Pro Handle,
125mm working length, straight shaft
straight jaw 225-700-820



Alligator Grasping Forceps, Pro Handle,
125mm working length, straight shaft
2.7mm straight jaw 225-700-825



Slide Lock Handle, 125mm working length
straight jaw 225-800-820



Slide Lock Handle, 125mm working length
2.7mm straight jaw 225-800-825

Mini Shark, 85mm working length
straight jaw 225-810-820

Mini Alligator, 85mm working length
straight jaw 225-810-825



Cupped Grasper
Cupped jaw with atraumatic serrations.



Cupped Grasper, straight shaft,
125mm working length, 3.3mm straight jaw
Pro Handle 225-700-833



125mm working length, 2.7mm straight jaw
Slide Lock Handle 225-800-832

ArthVANCE® Scissors



Hook Scissors

Hook Scissors, straight jaw, 3.5mm, Ring Handle, 125mm working length

straight shaft	225-800-472
15° left curved shaft	225-800-477
15° right curved shaft	225-800-479

Mini Hook Scissors, 2.7mm straight jaw, 85mm working length

straight shaft	225-810-472
----------------	-------------





ArthVANCE® Suture Cutter

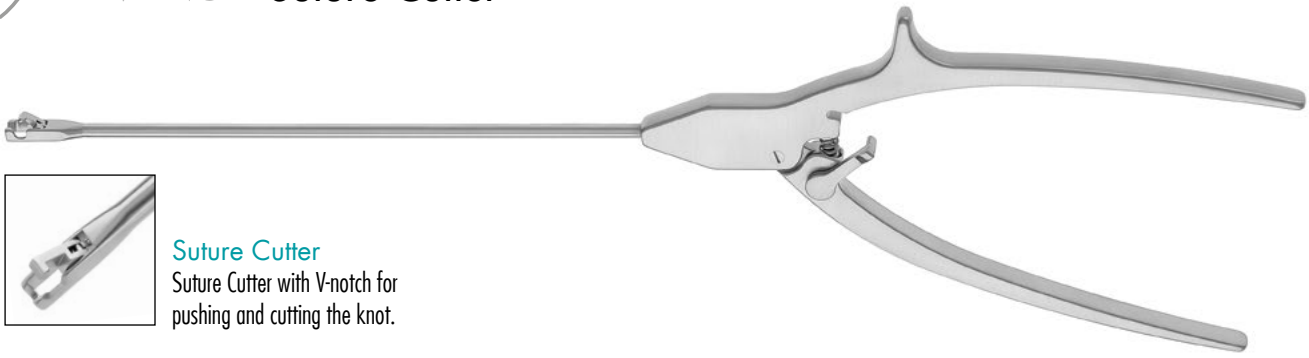

Suture Cutter

Suture Cutter with V-notch for pushing and cutting the knot.



Suture Cutter, v-notch, left opened, axial handle

155mm working length 225-820-100

ArthVANCE® Suction Punches



Suction Punches

Suction Punches feature an universal tube connector for simultaneous punching and evacuation of tissue, cartilage or bone parts.

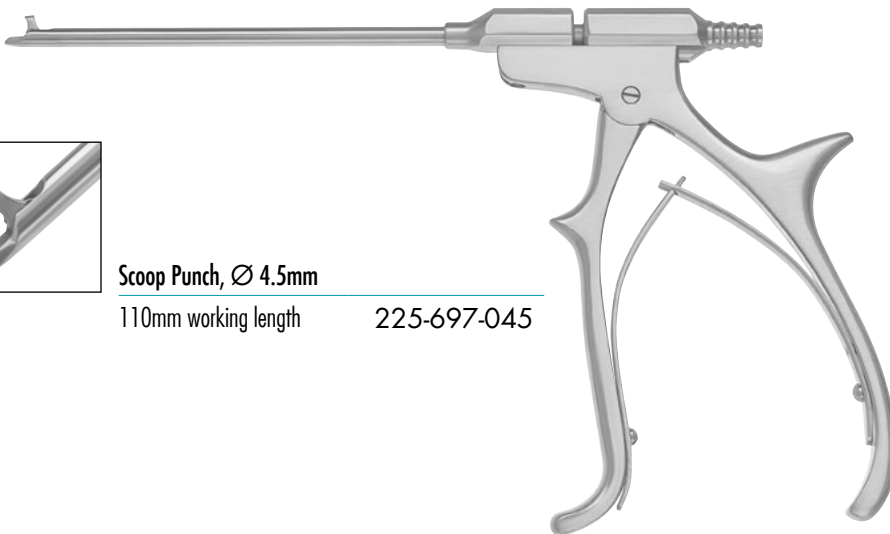

Scoop Punch, Ø 4.5mm

110mm working length 225-697-045



Scoop Punch, \varnothing 5.0mm
110mm working length 225-697-050

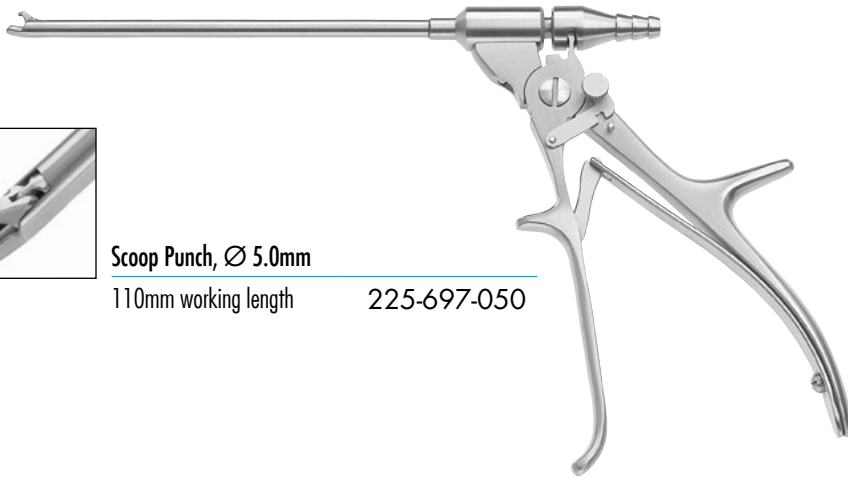

Retrograde Suction Punch, \varnothing 2.7mm,
with suction tube connector,
110mm working length
360° rotatable 225-699-027





Arthroscopic Instruments

Hooks, Probes and Curettes

The Arthvance Instruments provide for all joints and different anatomies the right pattern.





ArthVANCE® Probes



Hook Probe, synthetic handle

225-600-004



Exploring Probe, graduated

straight	225-090-001
curved	225-090-002



Probe Hook, graduated, 75mm working length

∅1.5mm	225-100-115
--------	-------------



Probe Hook, graduated, 140mm working length

∅2.3mm	225-100-123
--------	-------------



Exploring Probe, 5mm graduated, triangular handle

∅3.5mm	225-400-002
∅5.0mm	225-400-004



Hook Probe and Retractor, 40mm working length

45° angled, 3mm hook	225-400-103
90° angled, 2mm hook	225-400-102

ArthVANCE® Currettes / Spoons



Size 1 (Scale 1:1)



Size 2 (Scale 1:1)



Size 3 (Scale 1:1)



Size 1 (Scale 1:1)



Size 2 (Scale 1:1)



Size 3 (Scale 1:1)



Curette, 10° angled, 130mm working length

Size 1, Ø2.0mm	225-600-511
Size 2, Ø2.3mm	225-600-512
Size 3, Ø3.3mm	225-600-513



Curette, 20° angled, sharp on both sides, 130mm working length

Size 1, Ø2.0mm	225-600-521
----------------	-------------



Spoon, 5° slightly curved, 130mm working length

Size 1, Ø3.0 x 4.4mm	225-600-401
Size 2, Ø3.3 x 5.5mm	225-600-402
Size 3, Ø4.0 x 7.0mm	225-600-403



Mini Curette, sharp, straight, knurled handle, 90mm working length

Ø2.0mm	225-090-009
--------	-------------



Curette, sharp, 30° angled, knurled handle, 130mm working length

Ø3.0mm	225-100-006
--------	-------------



Ring Curette, sharp, 30° angled, knurled handle, 130mm working length

Ø3.0mm	225-100-008
Ø5.0mm	225-100-009



Curette, sharp, Ø3mm, triangular handle

30° angled	225-400-006
15° angled	225-400-008

Ø7mm

30° angled	225-400-009
------------	-------------

ArthVANCE® Meniscotomes / Knives

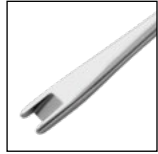

Smillie Meniscotome, straight edge, triangular handle

3.0mm 225-400-020
5.0mm 225-400-022

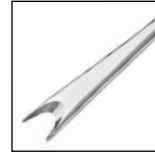

Smillie Meniscotome, curved edge, triangular handle

7.0mm 225-400-023



Smillie Meniscotome, straight edge, knurled handle, 130mm working length

3.0mm 225-100-020
5.0mm 225-100-022

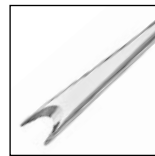

Smillie Meniscotome, curved edge, triangular handle, 130mm working length

7.0mm 225-100-023



Rosette Knife, triangular handle

3.0mm 225-400-025



Banana Knife, smooth, triangular handle

225-400-029



Scalpel Knife, triangular handle

225-400-034



Hook Knife, triangular handle

90° angled 225-400-038



Retrograde Knife, triangular handle

45° 225-400-041



Diamond Rasp, triangular handle

45° angled 225-400-045



Sickle Knife, triangular handle

225-400-043



Diamond Rasp, triangular handle

90° angled 225-400-090



**Rosette Knife, knurled handle,
130mm working length**

3.0mm

225-100-025



**Banana Knife, smooth, knurled handle,
130mm working length**

225-100-029



**Scalpel Knife, knurled handle,
130mm working length**

225-100-034



**Hook Knife, knurled handle,
130mm working length**

90° angled

225-100-038



**Retrograde Knife, knurled handle,
130mm working length**

45°

225-100-041



**Smillie Meniscotome, straight cutting edge
130mm working length**

3mm wide

225-100-020



**Mini Scalpel, knurled handle,
90mm working length**

∅ 2.0mm

225-090-006

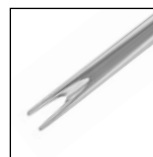

**Mini Knife, knurled handle,
90mm working length**

∅ 1.5mm

225-090-007



**Mini Sickle Knife, knurled handle,
90mm working length**

∅ 3.0mm

225-090-008



**Mini Rasp, knurled handle,
90mm working length**

concave jaw

225-090-004



**Mini Rasp, knurled handle,
90mm working length**

convex jaw

225-090-005



Micro Chondro Pick

25° angled

225-600-125

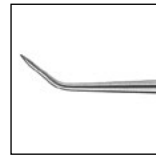

Micro Chondro Pick

45° angled

225-600-145



Micro Chondro Pick

60° angled

225-600-160

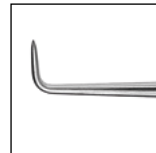

Micro Chondro Pick

90° angled

225-600-190



Mini Lambotte Osteotome, 125mm

2mm	210-136-002
3mm	210-136-003
4mm	210-136-004
5mm	210-136-005
6mm	210-136-006



Walter Osteotome, 190mm

2mm	420-580-002
3mm	420-580-003
4mm	420-580-004



Mallet, lead filled head, 80g

∅ 20mm	210-220-080
--------	-------------



Partsch Mallet, 120g

∅ 22mm	210-225-180
--------	-------------

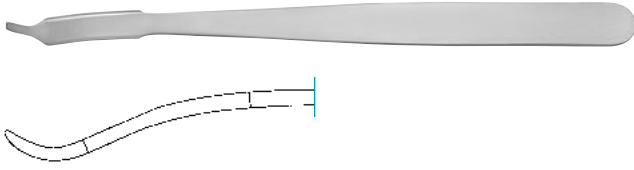

Mini Hohmann, Bone Lever, 2mm tip, 160mm

6mm wide 210-539-060

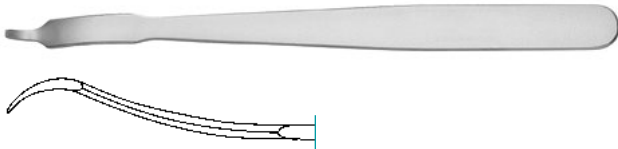

Hohmann, Bone Lever, 2mm tip, 160mm

8mm wide 210-541-080

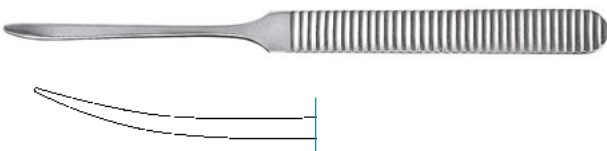

Williger, Elevator, 160mm

5.5mm wide 210-395-160

7.0mm wide 210-396-170



**Monopolar Needle Electrode, 90° angled,
115mm working length, 2.4mm connection**

∅ 1.5 x 0.6mm 225-710-001



**Monopolar Needle Electrode, 90° angled,
115mm working length, 2.4mm connection**

∅ 4.0 x 0.6mm 225-710-001

Arthroscopy Shaver System STUNNER S1

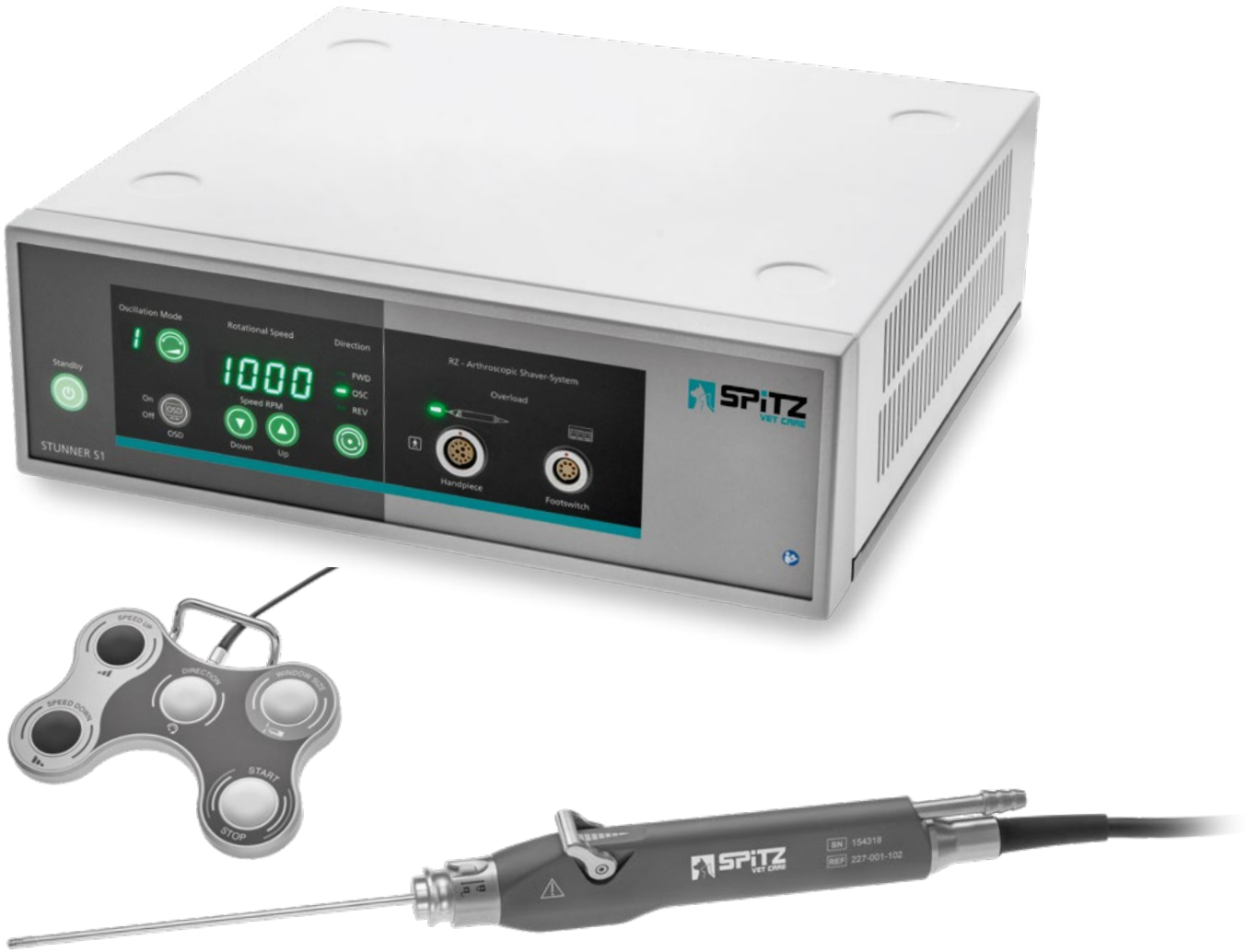

Features:

- 9 oscillation modes
- Controlled by buttons on the handpiece or by footswitch
- Fully autoclavable, small and ergonomic handpiece
- Dedicated shaver blades
- Open window function
- OSC up to 3500 rpm

**STUNNER S1 Unit,
complete with Hand Piece and Footswitch**

110 - 230V 227-001-110V

Control Unit

227-001-101V

Hand Piece

227-001-102V

Footswitch

227-001-103V



Shaver Blades



DR PitBull Shaver Blades
The universal blade for soft and hard tissue



DR WAVER Cutter Shaver Blades
The perfect blade for soft tissue resection

Non-sterile, 85mm working length

Ø 3.0mm 227-016-013

130mm working length

Ø 3.0mm 227-016-113

Ø 4.0mm 227-016-114

Non-sterile, 85mm working length

Ø 2.0mm 227-016-002

Ø 3.0mm 227-016-003

130mm working length

Ø 3.0mm 227-016-103

Ø 4.0mm 227-016-104

➔ more models available on request





Arthroscopy Pump P1

- Hydrostatic pressure regulation
- Silicone tubing set included (225-910-001)
- Easy to operate, splash-proofed display
- Highly reliable tube guide and handling
- Skid-proof pedestals

Arthroscopy Pump P1

110 - 230V	225-906-000V
Irrigation Tubing Set, silicone, autoclavable (included)	225-910-001
Irrigation Tubing Set, PVC, 20 pcs. daily tube, sterile (optional)	225-910-002
Patient Tube, PVC, 40 pcs., sterile (optional)	225-910-003



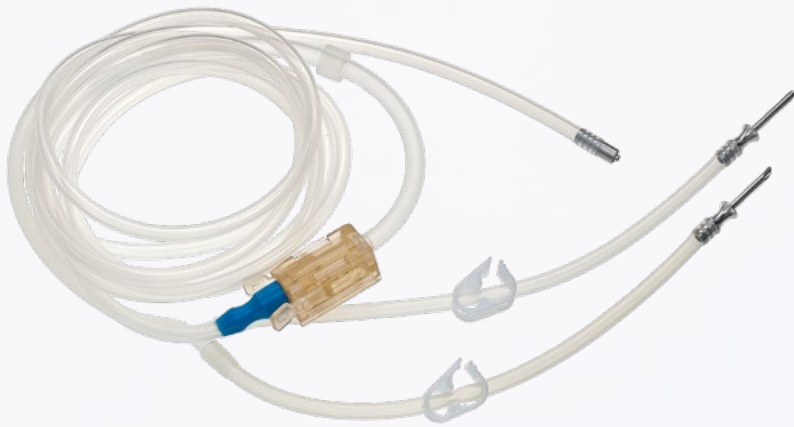

Silicone tubing set (included)

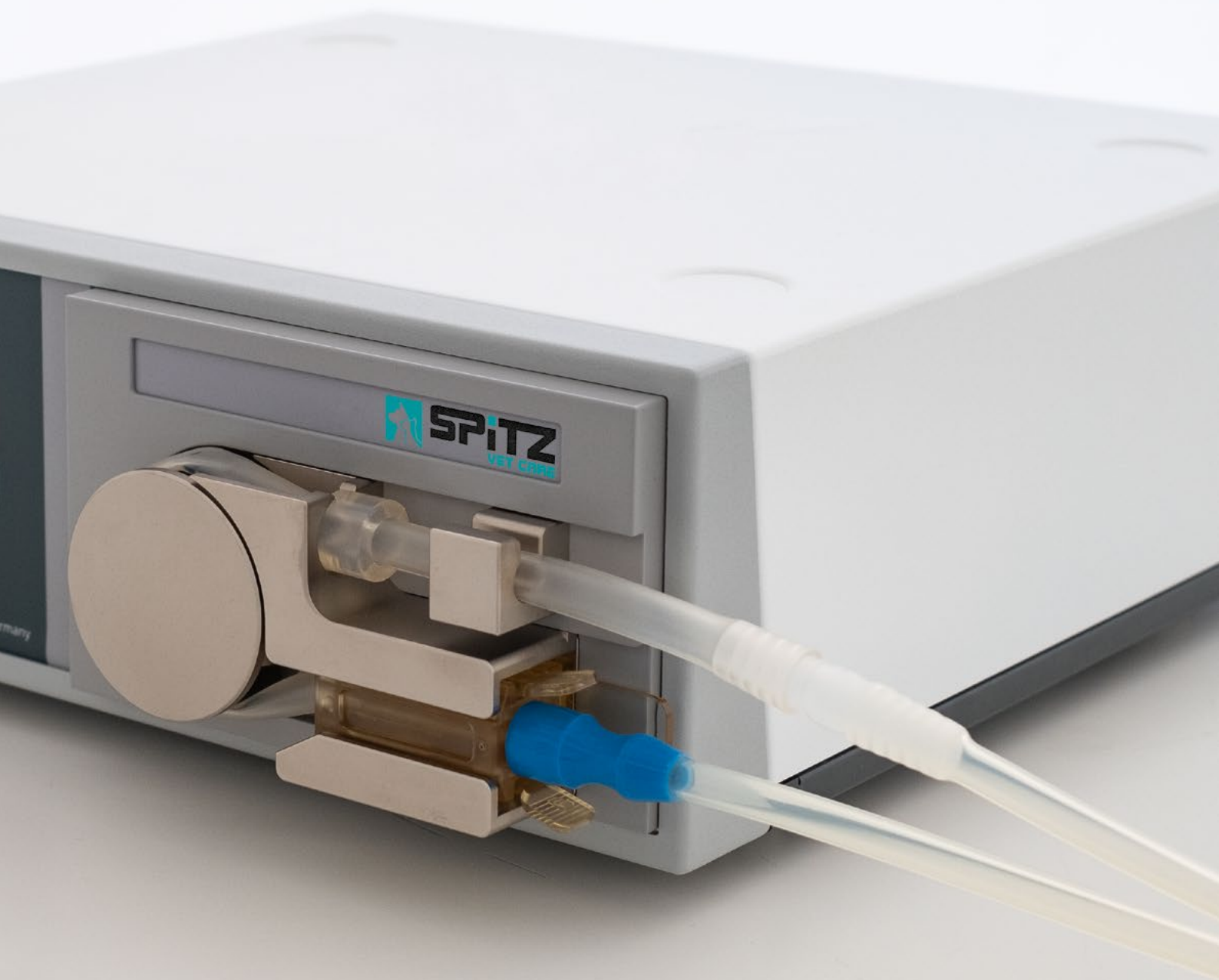



Container for Arthroscopy for 8 instruments in upright position with utility space for extra instruments

600-513-000

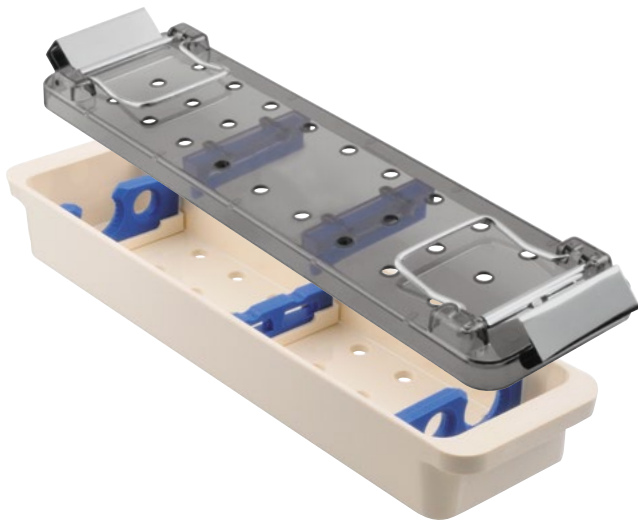

Safe+Clean double scope sterilization container for 2 short scopes with maximum length of 190mm

271 x 70 x 35 mm

600-505-002

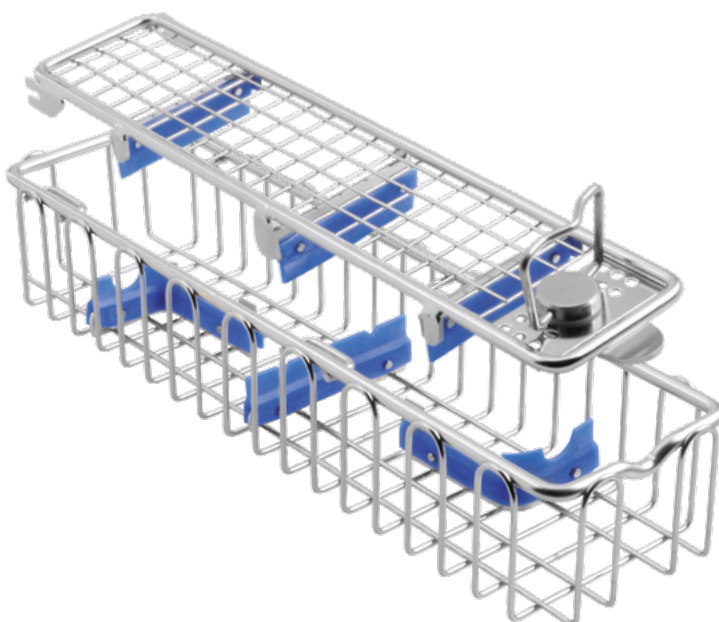

Endoscope cleaning basket, with silicone bars on base and lid, for max. 2 Endoscopes (190mm length)

290 x 80 x 52 mm

600-292-052



Endoscope Exchange Program

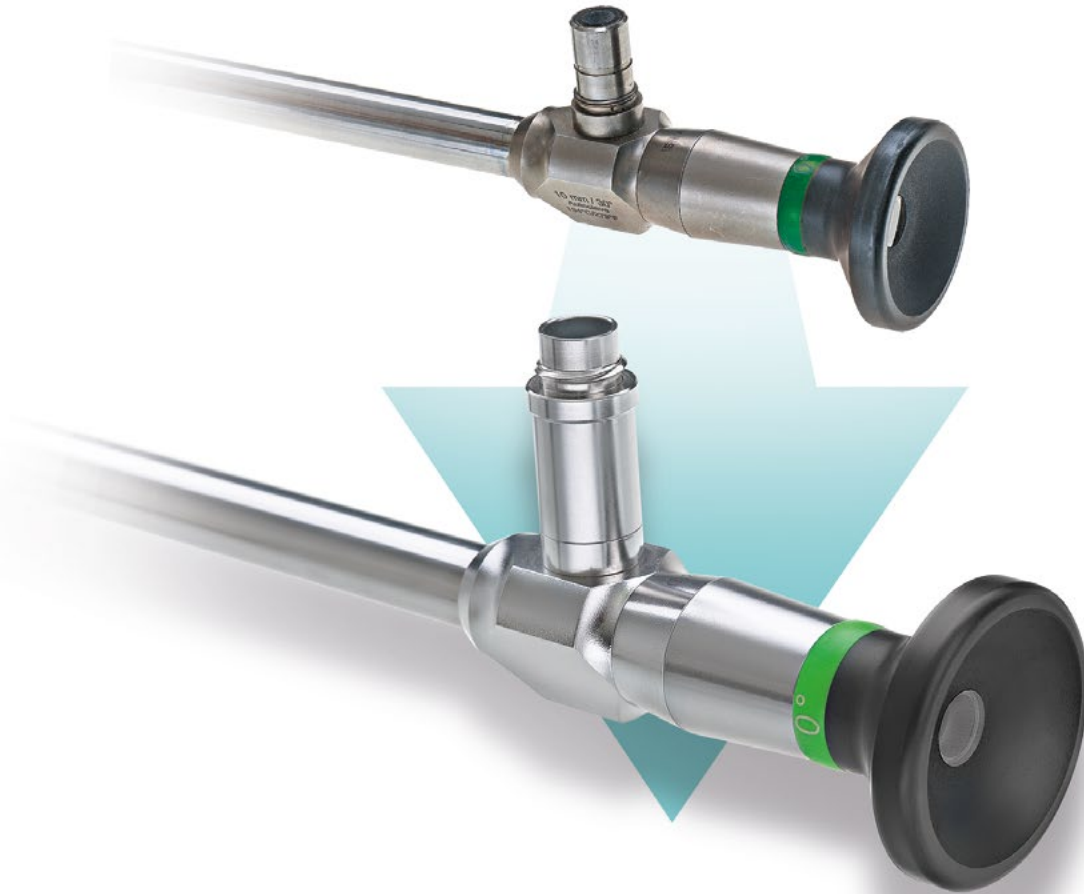

- Collect any kind of broken, damaged or used scope of any company from hospitals, private clinics, etc. and choose one of the listed Endoscopes for an excellent price
- Send us ANY TYPE of scope and choose a new SPiTZ scope
- Receive a brand new SPiTZ Endoscope with full warranty
- All components are new, no „Economy Class“ product, no recycled or reprocessed parts inside
- Fixed prices for a transparent budget

laparoscopy.







SPITZ TELESCOPES

- 3-step light post adapters to connect the most common light cables directly to the endoscope
- Sapphire glasses ensure highest stability against damages on the lens system
- Optimised glass fibre arrangements ensure a uniform image brightness of highest quality
- Full HD and 4K high definition pictures with increased detail-resolution through newest CAD - designed rod - lens systems
- Fully autoclavable at 134°C and 2.3bar

4K LAPAROSCOPES

State-of-the-art Laparoscopes to achieve excellent image quality and finest details in Ultra High Definition.

4K



4K Laparoscope, \varnothing 10mm, 330mm working length

0°	300-100-400
30°	300-100-430

450mm working length

0°	300-200-400
30°	300-200-430



4K Laparoscope, \varnothing 5mm, 300mm working length

0°	300-155-400
30°	300-155-430

450mm working length

0°	300-255-400
30°	300-255-430

FullHD Laparoscopes



Laparoscope, Ø 10mm, 330mm working length

0°	300-091-100
30°	300-091-130
45°	300-091-145
70°	300-091-170

430mm working length

0°	300-091-430
30°	300-091-433



Laparoscope, Ø 5mm, 300mm working length

0°	300-092-100
30°	300-092-130



Mini-Laparoscope, Ø 2.9mm, 207mm working length

0°	300-097-100
30°	300-097-130

FULL HD



Operating Laparoscope, \varnothing 10mm, with instrument channel
270mm working length, parallel view

0°

300-099-006



Operating Laparoscope, \varnothing 10mm, with instrument channel
270mm working length, lateral view

0°

300-099-106



FULL HD

Suction & Irrigation



Suction or irrigation tube with Luer-Lock,
4 x 4 holes and stopcock, \varnothing 5mm

330mm working length	300-006-305
450mm working length	300-006-455



Suction or irrigation tube with Luer-Lock,
4 holes, \varnothing 5mm

330mm working length	300-008-335
----------------------	-------------



Suction and irrigation cannula with Luer-Lock, 4 holes,
340mm working length

\varnothing 3mm	300-192-003
\varnothing 5mm	300-192-005
\varnothing 10mm	300-192-010
250mm working length	
\varnothing 3mm	300-192-253



Suction and irrigation handle, rotating 2-way lever
mechanism and 2 big universal tube adapters, with luer-lock

300-192-000

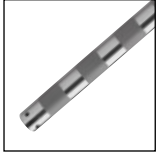

**Suction and irrigation cannula, 4 holes,
340mm working length**

∅ 3mm	300-172-003
∅ 5mm	300-172-005
∅ 10mm	300-172-010

250mm working length

∅ 3mm	300-172-253
-------	-------------



4x4 holes, 340mm working length

∅ 3mm	300-173-003
-------	-------------

250mm working length

∅ 3mm	300-173-253
-------	-------------



**Pistol-shaped suction and irrigation handle with 2-way valve
and 2 large universal tube connectors**

300-166-100





HF Electrodes



without suction



with suction



Monopolar Spatula Electrode,
Ø 5mm, with ceramic tip,
360mm working length

without suction

300-144-002

with suction

300-145-003



Monopolar L-Hook Electrode,
Ø 5mm, with ceramic tip,
360mm working length

without suction

300-144-005

with suction

300-145-005



Monopolar J-Hook Electrode,
Ø 5mm, with ceramic tip,
360mm working length

without suction

300-144-004

with suction

300-145-004



Monopolar Needle Electrode,
Ø 5mm, with ceramic tip,
360mm working length

without suction

300-144-006

with suction

300-145-006

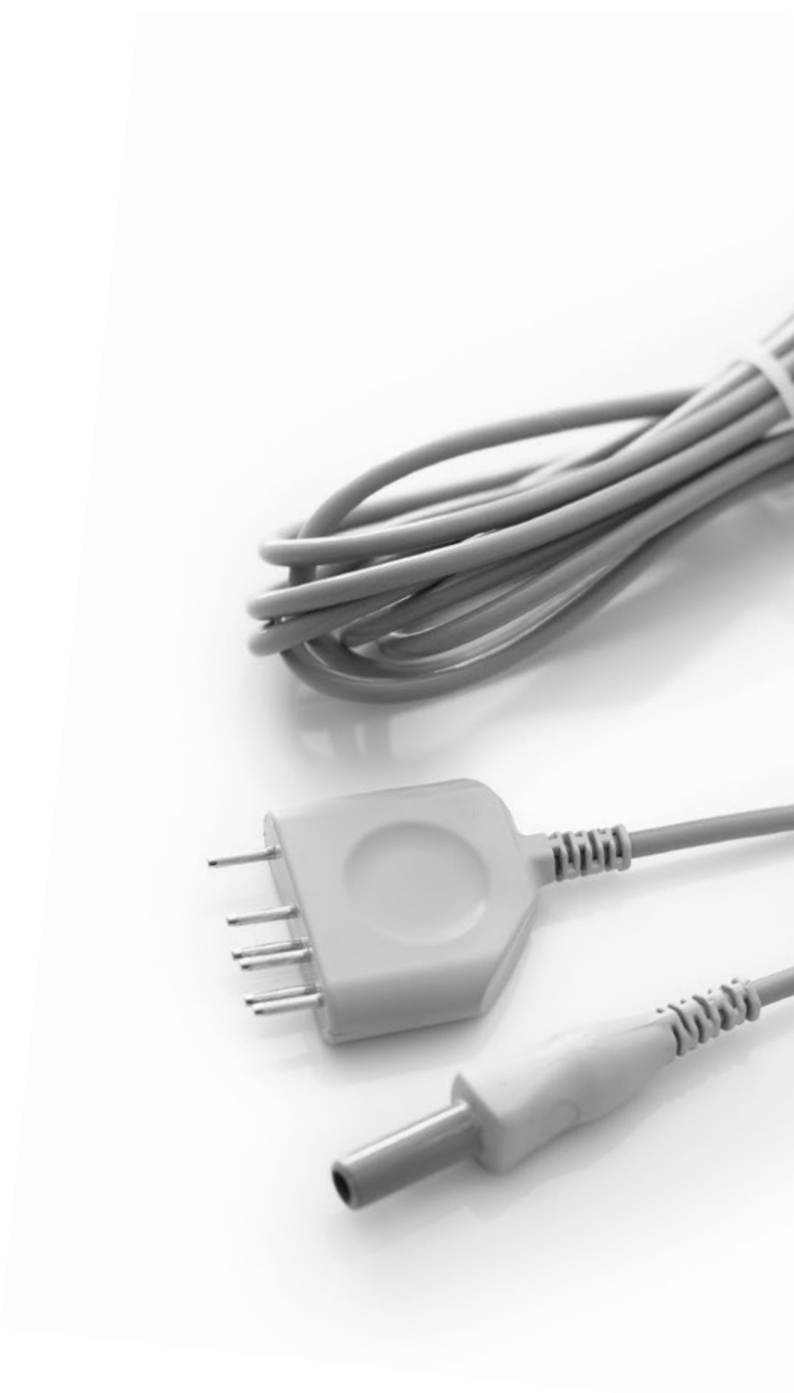

Monopolar HF Cables

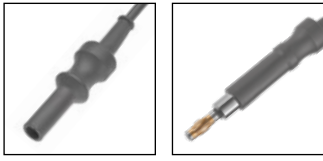

Erbe/ACC/ICC

3m	700-101-030
5m	700-101-050

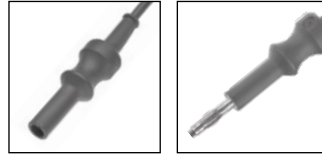

Erbe/Martin/Berchtold

3m	700-280-030
5m	700-280-050

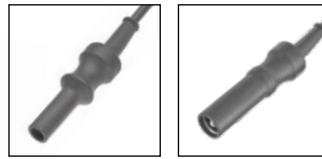

Martin/Berchtold

3m	700-285-030
5m	700-285-050

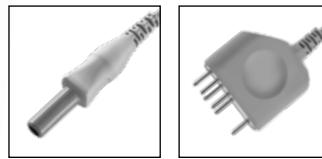

SPITZ HF Unit SDS Plug

3m	700-501-300
5m	700-501-500

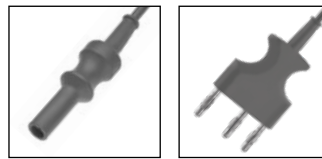

SPITZ HF Unit Standard Plug

3m	700-501-303
5m	700-501-503

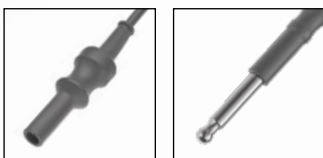

Bovie, Valleylab, Conmed

3m	700-360-031
5m	700-360-051

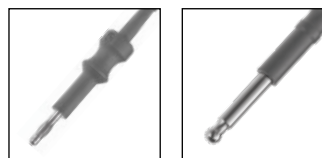

Bovie, Valleylab, Conmed

3m	700-370-030
5m	700-370-050



Multiport Trocar System

- Reusable and autoclavable seals
- Easy opening by pushing the lever
- Stainless Steel stopcock
- Ergonomic Stainless Steel housing
- Self-centering sleeves



MultiPort lever



Color Coded



Metal Housing

Color Coding	
Ø 5.5mm	●
Ø 11.0mm	●
Ø 13.0mm	●



Complete with Smooth Metal Sleeve,
105mm working length **A+B**

Ø 5.5mm	300-220-055
Ø 11.0mm	300-220-011
Ø 13.0mm	300-220-013

150mm working length

Ø 5.5mm	300-220-155
Ø 11.0mm	300-220-111
Ø 13.0mm	300-220-113

Spare Sleeve **A**

Ø 5.5mm	300-220-255
Ø 11.0mm	300-220-211
Ø 13.0mm	300-220-213



Complete with Threaded Metal Sleeve,
105mm working length **A+B**

Ø 5.5mm	300-221-055
Ø 11.0mm	300-221-011
Ø 13.0mm	300-221-013

Spare Sleeve **A**

Ø 5.5mm	300-221-255
Ø 11.0mm	300-221-211
Ø 13.0mm	300-221-213



Complete with Threaded Metal Sleeve, self-cutting
105mm working length **A+B**

Ø 5.5mm	300-226-055
Ø 11.0mm	300-226-011
Ø 13.0mm	300-226-013

Spare Sleeve **A**

Ø 5.5mm	300-236-255
Ø 11.0mm	300-236-211
Ø 13.0mm	300-236-213



Multiport Special Sized Trocar, oblique sleeve,
110mm working length **A+B**

Ø 15.0mm	300-020-015
----------	-------------

119mm working length **A+B**

Ø 20.0mm	300-020-020
----------	-------------

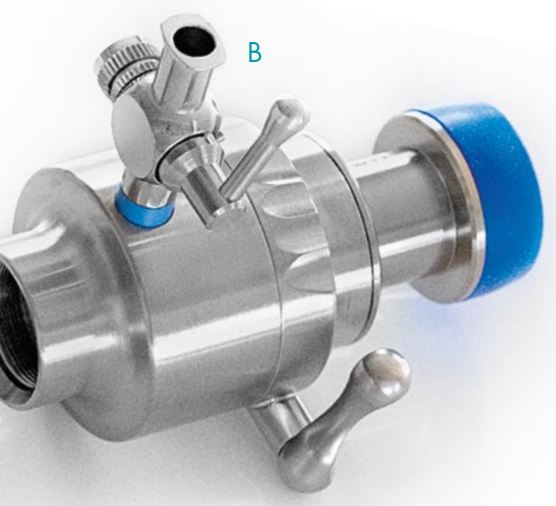

Complete with Smooth Metal Sleeve, oblique
105mm working length A+B

∅ 5.5mm	300-222-055
∅ 11.0mm	300-222-011
∅ 13.0mm	300-222-013

Spare Sleeve A

∅ 5.5mm	300-222-255
∅ 11.0mm	300-222-211
∅ 13.0mm	300-222-213



Complete with Smooth Synthetic Sleeve,
105mm working length A+B

∅ 5.5mm	300-233-055
∅ 11.0mm	300-233-011
∅ 13.0mm	300-233-013

Spare Sleeve A

∅ 5.5mm	300-233-255
∅ 11.0mm	300-233-211
∅ 13.0mm	300-233-213



Complete with Threaded Synthetic Sleeve,
105mm working length A+B

∅ 5.5mm	300-234-055
∅ 11.0mm	300-234-011
∅ 13.0mm	300-234-013

Spare Sleeve A

∅ 5.5mm	300-234-255
∅ 11.0mm	300-234-211
∅ 13.0mm	300-234-213

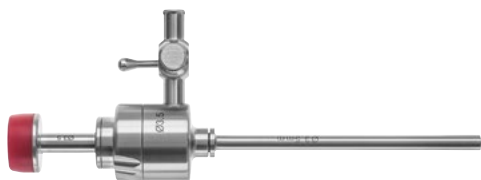

Multiport Mini Trocar,
70mm working length A+B

∅ 3.5mm	300-112-035
---------	-------------



Multiport Mini Trocar, threaded metal sleeve,
70mm working length A+B

∅ 5.5mm threads	300-221-755
∅ 5.5mm, threads, self-cutting	300-226-755

Siliport Trocar System

- Reusable and autoclavable seals
- Reusable and autoclavable silicon valve
- Stainless Steel stopcock
- Lightweight synthetic housing
- Self-centering sleeves

Color Coding	
Ø 5.5mm	●
Ø 11.0mm	●
Ø 13.0mm	●



Complete with Smooth Metal Sleeve,
105mm working length **A+B**

Ø 5.5mm	300-230-055
Ø 11.0mm	300-230-011
Ø 13.0mm	300-230-013

150mm working length

Ø 5.5mm	300-230-155
Ø 11.0mm	300-230-111
Ø 13.0mm	300-230-113

Spare Sleeve **A**

Ø 5.5mm	300-220-255
Ø 11.0mm	300-220-211
Ø 13.0mm	300-220-213



Complete with Threaded Metal Sleeve,
105mm working length **A+B**

Ø 5.5mm	300-231-055
Ø 11.0mm	300-231-011
Ø 13.0mm	300-231-013

Spare Sleeve **A**

Ø 5.5mm	300-221-255
Ø 11.0mm	300-221-211
Ø 13.0mm	300-221-213



Complete with Threaded Metal Sleeve, self-cutting
105mm working length **A+B**

Ø 5.5mm	300-236-055
Ø 11.0mm	300-236-011
Ø 13.0mm	300-236-013

Spare Sleeve **A**

Ø 5.5mm	300-236-255
Ø 11.0mm	300-236-211
Ø 13.0mm	300-223-213



Lightweight housing



Color Coded



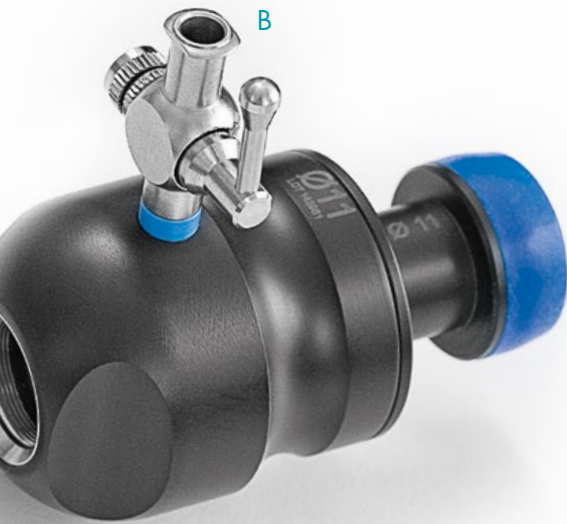

Complete with Smooth Metal Sleeve, oblique
105mm working length **A+B**

Ø 5.5mm	300-232-055
Ø 11.0mm	300-232-011
Ø 13.0mm	300-232-013

Spare Sleeve **A**

Ø 5.5mm	300-222-255
Ø 11.0mm	300-222-211
Ø 13.0mm	300-222-213



Complete with Smooth Synthetic Sleeve,
105mm working length **A+B**

Ø 5.5mm	300-233-055
Ø 11.0mm	300-233-011
Ø 13.0mm	300-233-013

Spare Sleeve **A**

Ø 5.5mm	300-233-255
Ø 11.0mm	300-233-211
Ø 13.0mm	300-233-213



Complete with Threaded Synthetic Sleeve,
105mm working length **A+B**

Ø 5.5mm	300-234-055
Ø 11.0mm	300-234-011
Ø 13.0mm	300-234-013

Spare Sleeve **A**

Ø 5.5mm	300-234-255
Ø 11.0mm	300-234-211
Ø 13.0mm	300-234-213

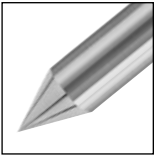

**Standard Trocar, reusable, cutting conical tip**

∅ 3.5mm	300-240-035
∅ 5.5mm	300-240-055
∅ 11.0mm	300-240-011
∅ 13.0mm	300-240-013
∅ 15.0mm	300-240-015
∅ 20.0mm	300-240-020

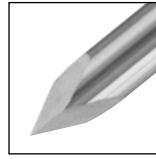
**Standard Trocar, reusable, cutting pyramidal tip**

∅ 3.5mm	300-241-035
∅ 5.5mm	300-241-055
∅ 11.0mm	300-241-011
∅ 13.0mm	300-241-013
∅ 15.0mm	300-241-015
∅ 20.0mm	300-241-020

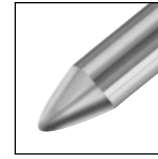
**Hasson Trocar, reusable, atraumatic blunt ball tip**

∅ 3.5mm	300-242-035
∅ 5.5mm	300-242-055

XL Trocar, 150mm working length

∅ 5.5mm	300-241-155
---------	-------------

Trocar, 70mm working length

∅ 5.5mm	300-239-750
---------	-------------

Trocar, 70mm working length

∅ 5.5mm	300-239-755
---------	-------------

**Safety Trocar System 160mm working length**

∅ 5.5mm	300-152-055
---------	-------------

170mm working length

∅ 11.0mm	300-152-011
∅ 12.5mm	300-152-012



Shielded trocar tip



Sharp trocar tip

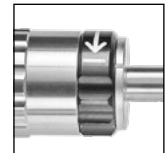

Safety mechanism

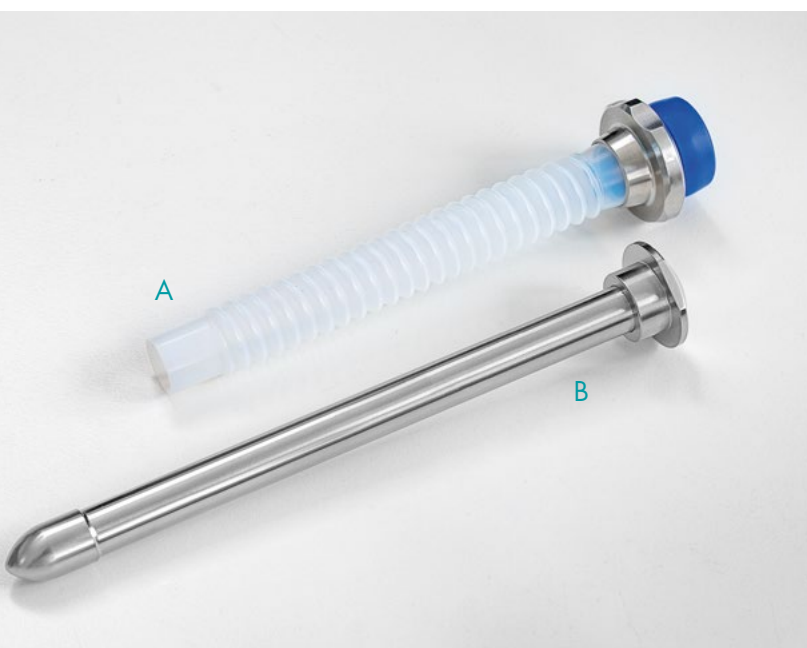
**Flexible Thorax Trocar System 100mm working length A+B**

∅ 5.5mm	●	300-020-255
∅ 11.0mm	●	300-020-211

Obturator B

∅ 5.5mm	300-023-255
∅ 11.0mm	300-023-711

Flexible Thorax Trocar System 70mm working length A+B

∅ 5.5mm	●	300-020-755
∅ 11.0mm	●	300-020-711

Obturator B

∅ 5.5mm	300-023-755
∅ 11.0mm	300-023-711



Sealing Caps, 10 pcs.

for \varnothing 3.5mm	●	300-250-035
for \varnothing 5.5mm	●	300-250-055
for \varnothing 11.0mm	●	300-250-011
for \varnothing 13.0mm	●	300-250-013



Inner Gaskets for MultiPort, 10 pcs.

for \varnothing 3.5mm	●	300-250-235
for \varnothing 5.5mm	●	300-250-255
for \varnothing 11.0mm	●	300-250-211
for \varnothing 13.0mm	●	300-250-213
for \varnothing 15.0mm	●	300-250-215
for \varnothing 20.0mm	●	300-250-220

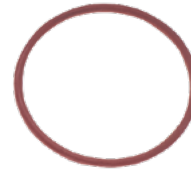

Gaskets for MultiPort, 10 pcs.

for \varnothing 3.5mm	300-250-135
for \varnothing 5.5mm	300-250-135
for \varnothing 11.0mm	300-250-111
for \varnothing 13.0mm	300-250-111



Reducer Sleeve, 60mm

\varnothing 10mm \rightarrow 5.0 mm	300-012-106
\varnothing 11mm \rightarrow 5.5 mm	300-012-116
\varnothing 12.5mm \rightarrow 5.5 mm	300-012-121



Reducer Clip with silicone band

\varnothing 11mm \rightarrow 5.5mm	300-021-011
\varnothing 12.5mm \rightarrow 5.5mm	300-021-125



Reducer Clip with silicone band

\varnothing 11mm \rightarrow 5.5mm	300-021-355
\varnothing 13mm \rightarrow 5.5mm	300-021-305
\varnothing 13mm \rightarrow 10.0mm	300-021-310



Veress Insufflation Needle, \varnothing 2.0mm

100mm working length	300-195-100
120mm working length	300-195-120
150mm working length	300-195-150
170mm working length	300-195-170
200mm working length	300-195-200

Ring Handle Instruments

- Reusable 3-piece instruments
- Ergonomic design
- Interchangeable inserts
- Modular, cost-effective system



PEEK Polymer Handle with HF connection

300-750-101



PEEK Polymer Handle with ratchet and HF connection

300-750-103



PEEK Polymer Handle with hook up ratchet and HF connection

300-750-105



PEEK Polymer Handle with swing-away ratchet and HF connection

300-750-106



Metal Handle with inner ratchet

300-750-020



Axial Handle with catch, one golden ring

300-750-115



Outer Sheath, insulated, 330mm

- ∅ 5mm 300-660-005
- ∅ 10mm 300-660-010



Maryland Extra Fine Dissector,
gently curved, double action, ∅ 5mm



Insert only

300-400-731



Complete Instrument with shaft
and handle 300-750-101

300-420-731



Dissecting Grasping Forceps, fine serrated
jaws, right angled, double action, ∅ 5mm



Insert only

300-400-735



Complete Instrument with shaft
and handle 300-750-101

300-420-735



Overholt Dissecting Forceps,
90° angled jaws, double action, Ø 10mm

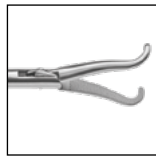

Insert only

300-400-741



Complete Instrument with shaft
and handle 300-750-101

300-420-741



Kelly Dissecting Forceps, curved,
slightly tapered, cross-serrated jaws, wide
opening, double action, Ø 5 mm



Insert only

300-400-732



Complete Instrument with shaft
and handle 300-750-101

300-420-732



Mixer Fine Dissecting Forceps, 90° angled,
fine serrated jaws, double action, Ø 5 mm



Insert only

300-400-738



Complete Instrument with shaft
and handle 300-750-101

300-420-738



DeBakey Pick-Up Forceps, 38mm jaws,
22mm serration, double action, Ø 5mm



Insert only

300-400-243



Complete Instrument with shaft
and handle 300-750-103

300-440-243



Complete Instrument with shaft
and handle 300-750-105

300-470-243



DeBakey Grasping Forceps, 25mm jaws, double action, Ø 5mm



Insert only

300-400-244



Complete Instrument with shaft and handle 300-750-103

300-440-244



Complete Instrument with shaft and handle 300-750-105

300-470-244



Johans Grasping Forceps, 20mm fenestrated jaws, double action, Ø 5mm

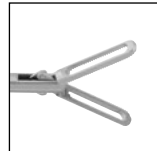

Insert only

300-400-289



Complete Instrument with shaft and handle 300-750-103

300-440-289



Complete Instrument with shaft and handle 300-750-105

300-470-289



Babcock Paddle Grasping Forceps, flat paddles, double action, Ø 5mm

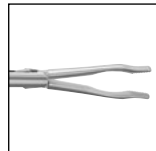

Insert only

300-400-250



Complete Instrument with shaft and handle 300-750-103

300-440-250



Complete Instrument with shaft and handle 300-750-105

300-470-250



Babcock Grasping Forceps, single action, Ø 5mm



Insert only

300-400-251



Complete Instrument with shaft and handle 300-750-101

300-420-251



Babcock Grasping Forceps, rounded jaws fine serrations, double action, Ø 5mm

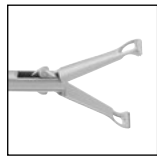

Insert only

300-400-252



Complete Instrument with shaft and handle 300-750-103

300-440-252



Complete Instrument with shaft and handle 300-750-105

300-470-252



Grasping Forceps with biopsy cup, heavy pattern, double action, Ø 5mm



Insert only

300-400-000



Complete Instrument with shaft and handle 300-750-103

300-440-000



Complete Instrument with shaft and handle 300-750-105

300-460-000



Bullnose Grasping Forceps, heavy pattern, double action, Ø 5mm



Insert only

300-400-001



Complete Instrument with shaft and handle 300-750-103

300-440-001



Complete Instrument with shaft and handle 300-750-105

300-460-001

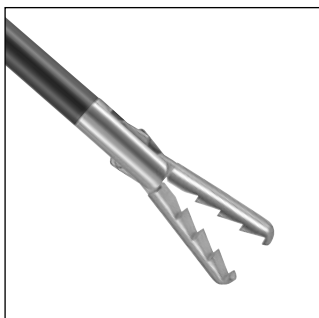

Alligator Grasping Forceps, strong retrograde serrations, double action, Ø 5mm

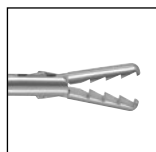

Insert only

300-400-010



Complete Instrument with shaft and handle 300-750-103

300-440-010



Complete Instrument with shaft and handle 300-750-105

300-460-010



Shark Grasping Forceps, very sharp, aggressive lateral retrograde teeth, double action, Ø 5mm

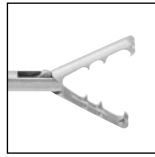

Insert only

300-400-048



Complete Instrument with shaft and handle 300-750-103

300-440-048



Complete Instrument with shaft and handle 300-750-105

300-460-048



Biospy Forceps, 2 pinholes, sharp oval cups, double action, Ø 5mm



Insert only

300-400-080



Complete Instrument with shaft and handle 300-750-101

300-420-080



Martin Grasping Forceps with multiple fine serrations, 4.8 mm wide jaws, single action, Ø 5mm



Insert only

300-400-011



Complete Instrument with shaft and handle 300-750-105

300-460-011



Martin Grasping Forceps with multiple fine serrations, 4.8 mm wide jaws, single action, Ø 5mm



Insert only

300-400-011



Complete Instrument with shaft and handle 300-750-103

300-440-011

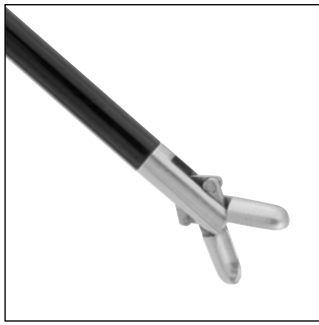

Biopsy Forceps, sharp oval cups, double action, Ø 5mm

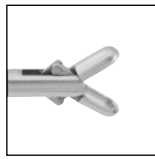

Insert only

300-400-082



Complete Instrument with shaft and handle 300-750-101

300-420-082



Hook Scissors, round cutting blades, single action, Ø 5mm



Insert only

300-400-060



Complete Instrument with shaft and handle 300-750-101

300-420-060



Metzenbaum Scissors, 12mm short blades, slightly curved, double action, Ø 5mm

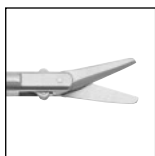

Insert only

300-400-067



Complete Instrument with shaft and handle 300-750-101

300-420-067



Metzenbaum Scissors, 15mm medium blades, straight, double action, Ø 5mm

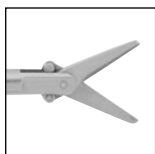

Insert only

300-400-068



Complete Instrument with shaft and handle 300-750-101

300-420-068



Metzenbaum Scissors, 12mm short blades, straight, double action, Ø 5mm



Insert only

300-400-069



Complete Instrument with shaft and handle 300-750-101

300-420-069



Metzenbaum Scissors, 15mm long blades, slightly curved, double action, Ø 5mm



Insert only

300-400-070



Complete Instrument with shaft and handle 300-750-101

300-420-070



Detachable Bipolar Forceps

- 360° rotatable
- Consists of forceps body & shaft - without electrode

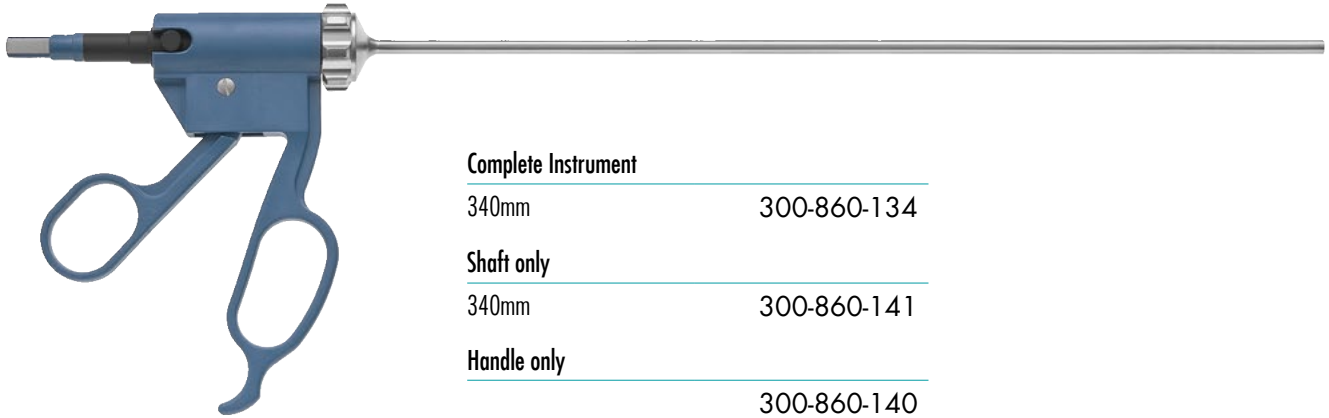

Bipolar Electrode Inserts

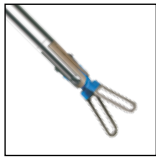

Duckbill Forceps

Ø 5mm

300-860-016

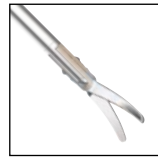

TC Metzenbaum Scissors

Ø 5mm

300-860-018

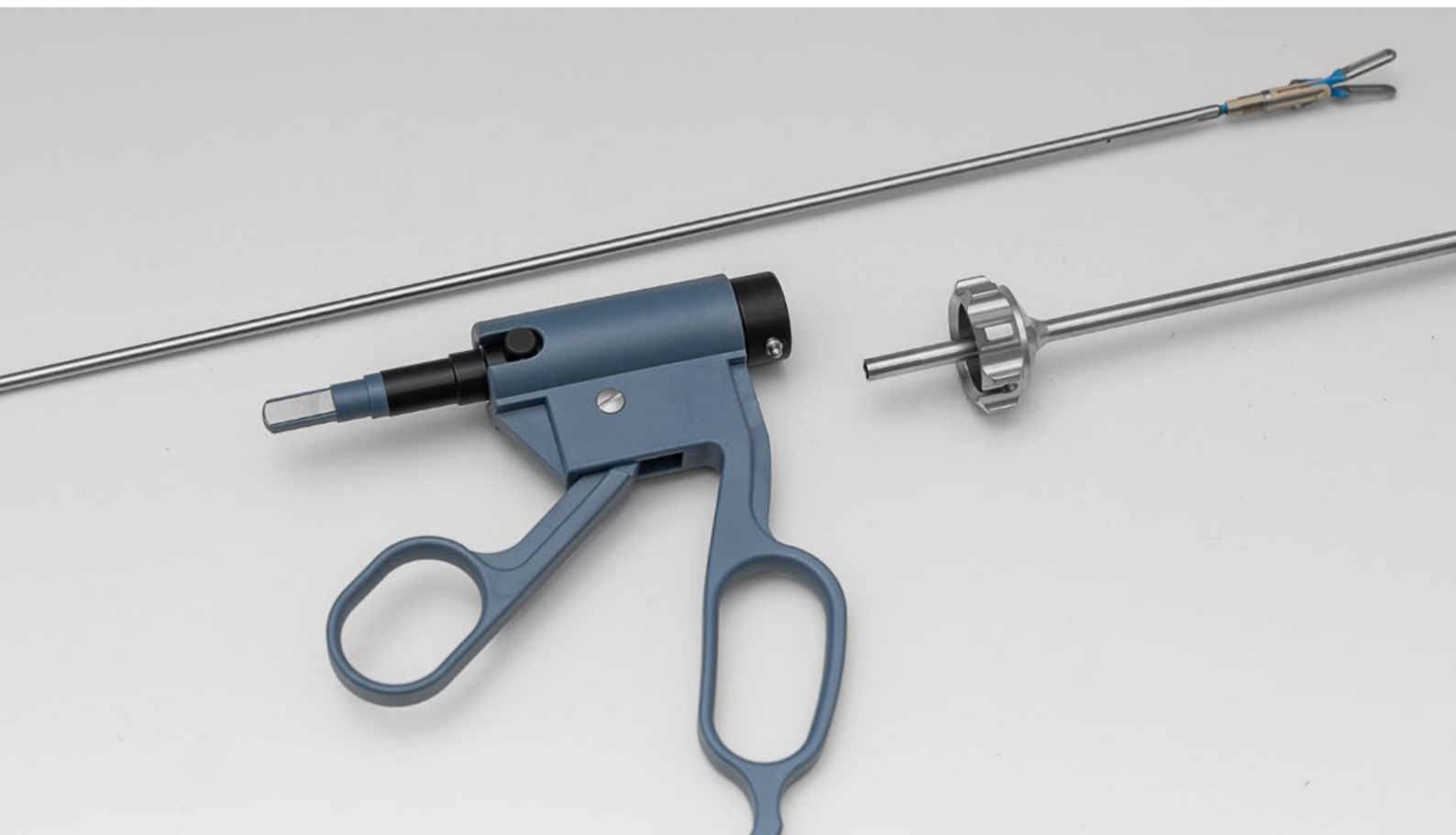

Instruments

**Palpation Probe, graduated, 330mm working length**

∅ 2.8mm	300-193-303
---------	-------------

300mm working length

∅ 5.0mm	300-193-305
---------	-------------

330mm working length

∅ 5.0mm	300-193-335
---------	-------------

400mm working length

∅ 5.0mm	300-193-405
---------	-------------

∅ 10.0mm	300-193-410
----------	-------------

**Knot Pusher, closed, 330mm working length**

∅ 4mm	300-030-004
-------	-------------

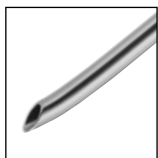
**Guide Tube for Cholangiography Catheter,
330mm working length**

∅ 5mm	300-193-330
-------	-------------

**Endo Dilator Speculum**

195mm	300-023-100
-------	-------------



Endoscopic Needle Holder

- One-piece Instrument
- Ergonomic and extremely lightweight (120g)
- Aluminium anodized handle
- Corrosion protection



Lightweight design with satin black surface



65° Luer-Lock flushing port for optimal accessibility



6-tooth ratchet for always optimal positioning, with overload protection



Straight, TC Inserts, Ø 5mm

330mm working length	300-300-130
450mm working length	300-300-230



Concave/convex, diamond dusted jaw, 330mm working length

Ø 5mm	300-300-142
-------	-------------



Fan Retractors & Band Passer

- Flush Port System
- Vertical adjustment of max. 50°

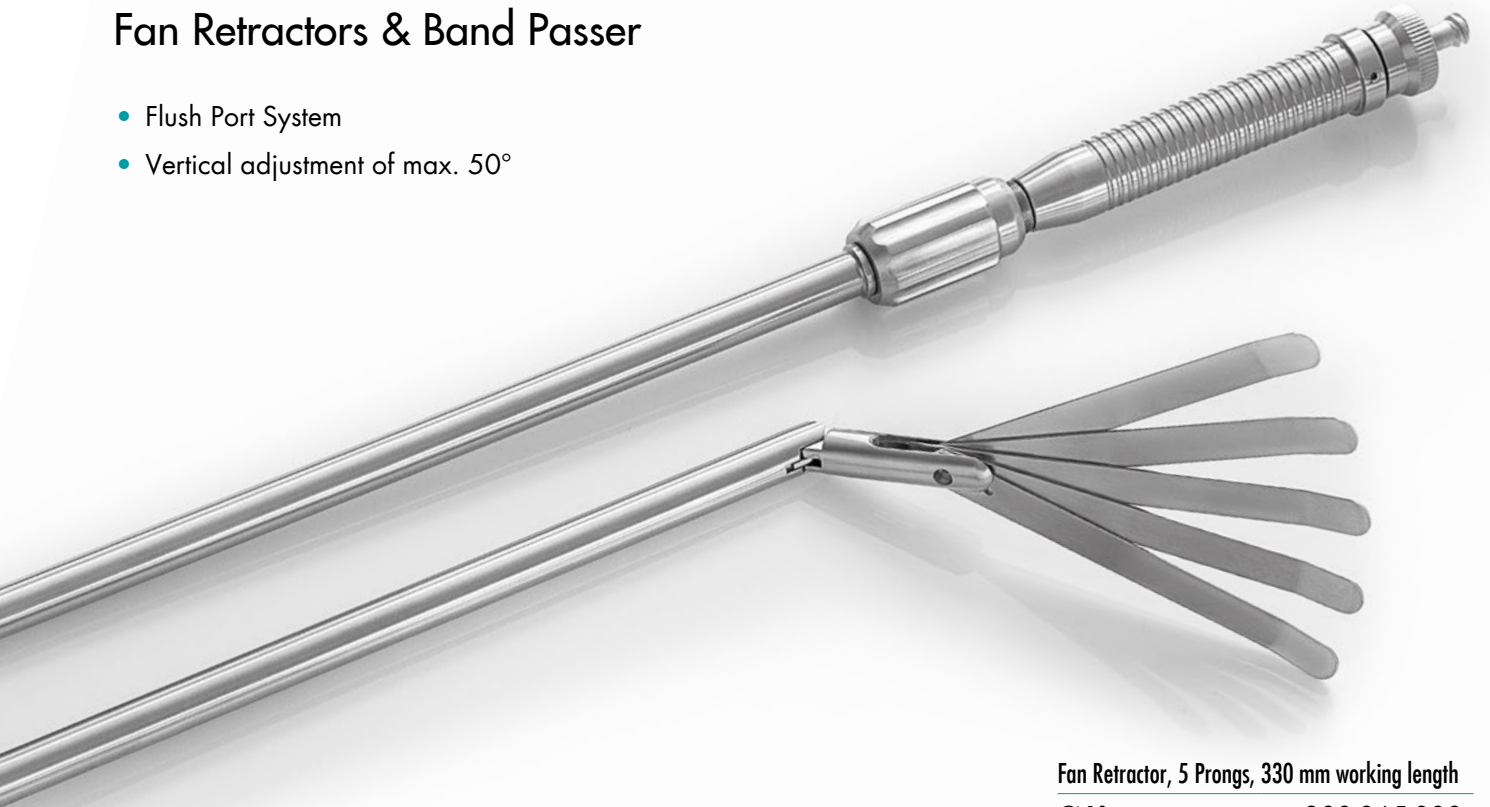

Fan Retractor, 5 Prongs, 330 mm working length

Ø 10mm

300-065-000

- Easy to use with 5.0 / 5.5 trocar sleeves
- Carbon handle
- Nitinol wire to straighten

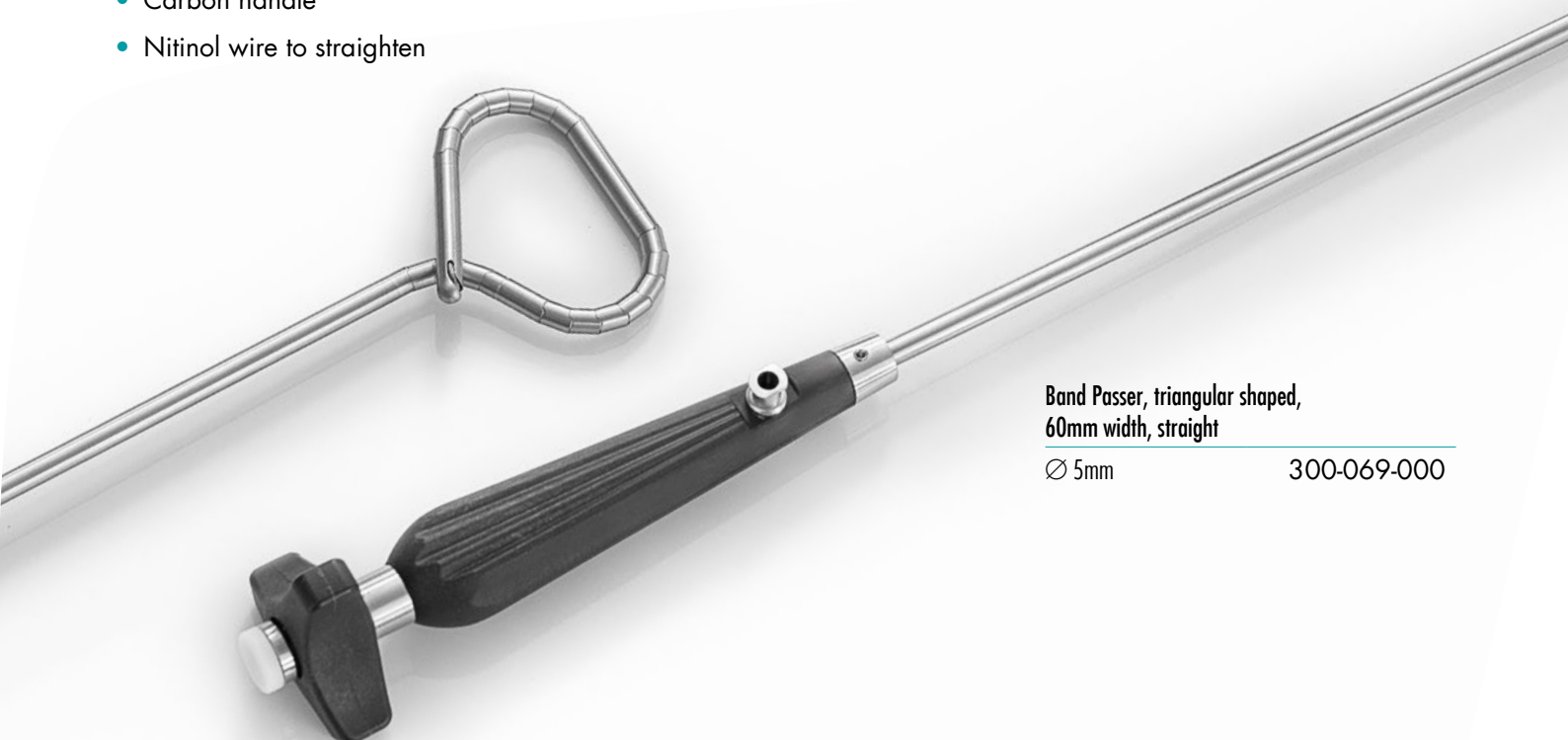

Band Passer, triangular shaped,
60mm width, straight

Ø 5mm

300-069-000

Nathanson Liver Retractor

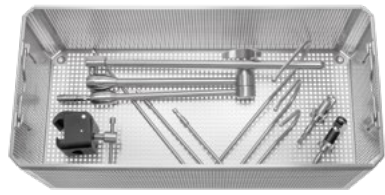
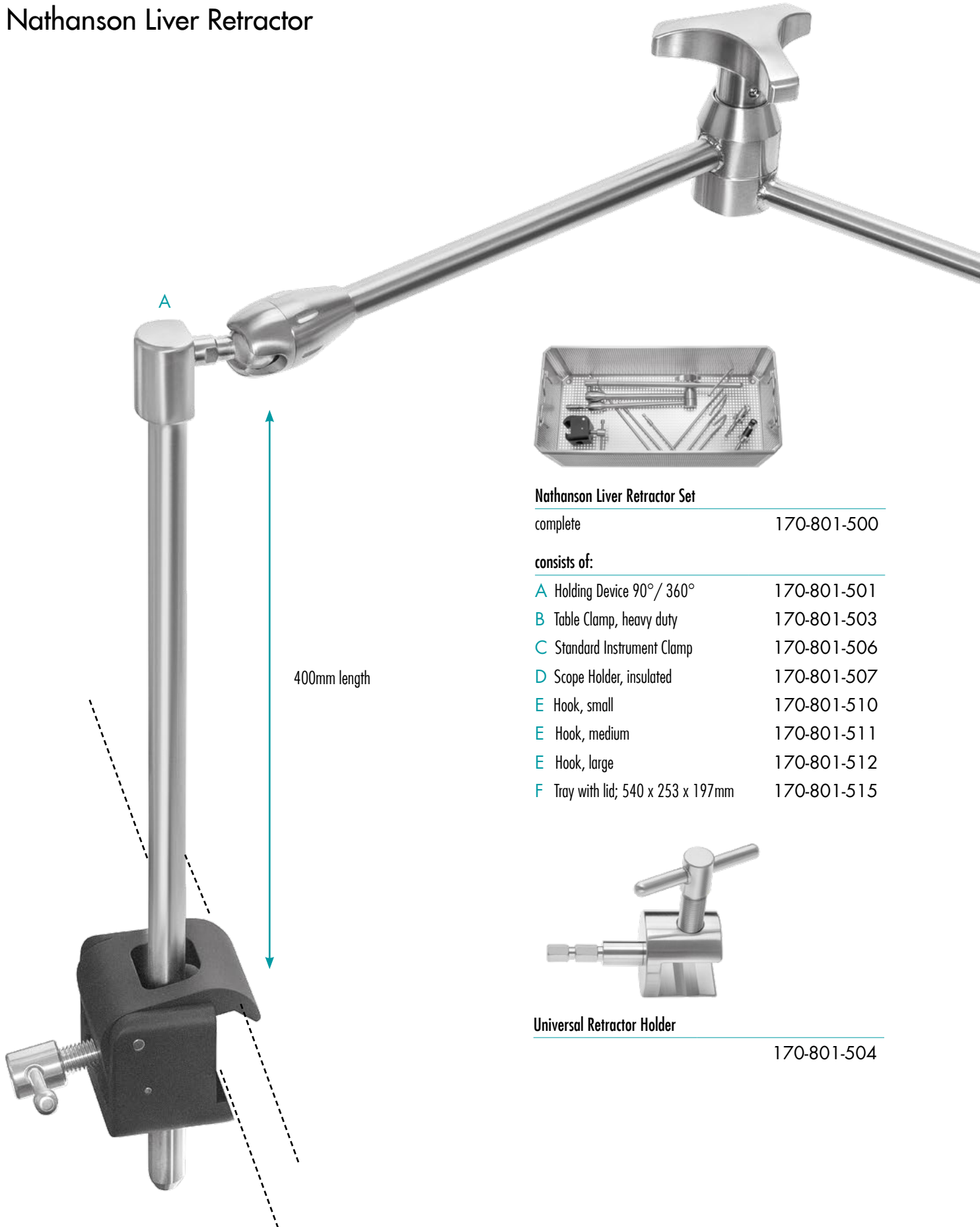

Nathanson Liver Retractor Set

complete 170-801-500

consists of:

A	Holding Device 90°/ 360°	170-801-501
B	Table Clamp, heavy duty	170-801-503
C	Standard Instrument Clamp	170-801-506
D	Scope Holder, insulated	170-801-507
E	Hook, small	170-801-510
E	Hook, medium	170-801-511
E	Hook, large	170-801-512
F	Tray with lid; 540 x 253 x 197mm	170-801-515



Universal Retractor Holder

170-801-504

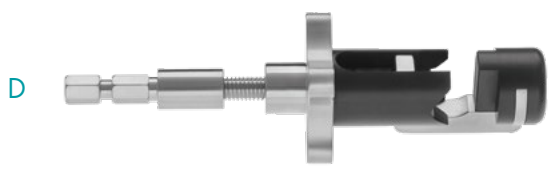

E

devices.





Our complete system for high-definition endoscopic, laparoscopic and arthroscopic surgery.

We support the needs you have and provide you the options for your individual configuration.

Universal and flexible "All in One Solution" for diagnostics and endoscopic therapy. The complete system can be easily transported, intuitively set up and used. The ultra-high resolution monitor and FullHD camera produce a high-quality image and the 60W equivalent light source provides good illumination.

- 4K HD 17,3" monitor
- LED Light Source, 60W equivalent
- Disinfectable FullHD camera for flexible and rigid optics with zoom adapter
- Endoscopic platform with video and image recorder and network connection

300-490-001

ALL IN ONE FULL HD SYSTEM

consisting of:

- A Camera head, Full HD
- B TV-Adapter, f1.4 to f3.5
- C Light guide cable with adapter
- D Laptop with software, LED Light source
- E Suitcase



Mobile endoscopy becomes possible with this High Definition camera that allows endoscopic examination with all required parts in one complete set. Integrated illumination and a high-performance camera head, powered by an external Desktop-Computer or Laptop via USB 3.0 makes examination and clinical surgery possible.

- Full HD (1920 x 1080) recording function (images / video)
- Powered by USB connection (USB 3.0 required)
- Long-life LED illumination
- Programmable camera head with adjustable brightness
- Easy software installation and interface (Software incl. patient management/storage)
- Lightweight, ready-to use design



300-001-480
FULL HD CAMERA SET

consisting of:

- A Camera head
- B Endoscope coupler
- C Light source
- D Suitcase
- E Software



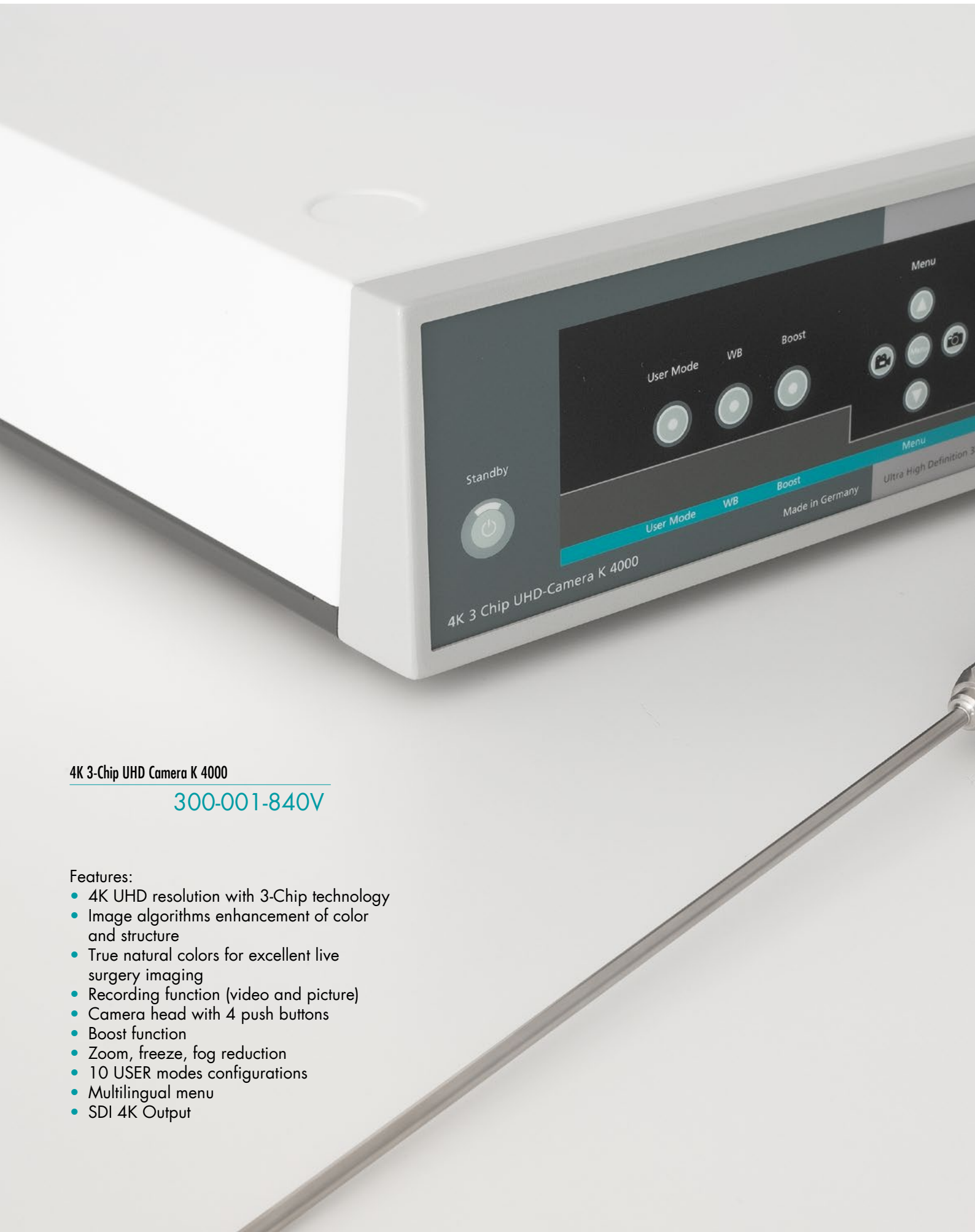

4K 3-Chip UHD Camera K 4000

[300-001-840V](#)

Features:

- 4K UHD resolution with 3-Chip technology
- Image algorithms enhancement of color and structure
- True natural colors for excellent live surgery imaging
- Recording function (video and picture)
- Camera head with 4 push buttons
- Boost function
- Zoom, freeze, fog reduction
- 10 USER modes configurations
- Multilingual menu
- SDI 4K Output



UHD 3-Chip Camera Head

(included)

300-001-841

4K

**Ultra High Definition Quality
3840 x 2160 PIXELS**

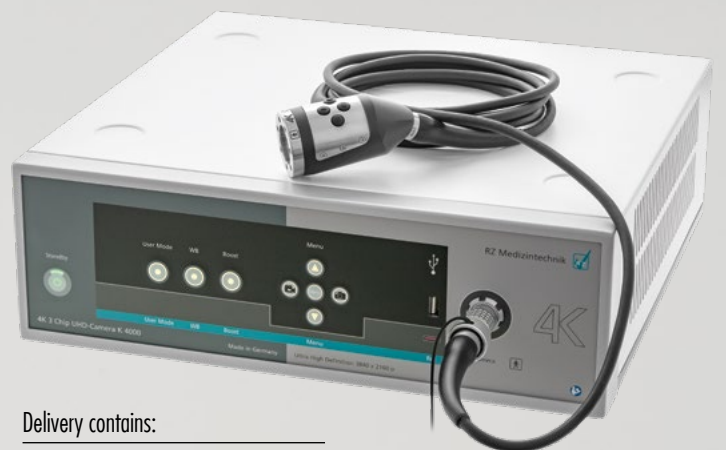

Delivery contains:

- Main Unit (300-001-840V)
- Camera head (300-001-841)
- HDMI cable
- USB Pen Drive
- Mains cable
- Operating manual



Recording function on
USB pen drive



Camera head with 4
raised push buttons

Features:

- Pure Natural Colors technology
- Multitude of digital video outputs for best possible picture transmission to medical grade monitors
- Ergonomic camera head with 3 programmable remote control buttons
- User-friendly multilingual menu allows a large variety of setups for individual procedures and surgeons preferences
- Full HD 60fps video recording
- Full HD image saving
- USB pen drive included
- Text generator (optional with keyboard)
- Documentation System

FULL HD
1-CHIP FULL HD
1920 x 1080
PIXELS



F2 Camera Head

(included)

300-001-602



Delivery contains:

- Main Unit
- Camera head
- HDMI-DVI cable
- HDMI cable
- S-Video cable
- RGB cable
- BNC cable
- USB Pen Drive
- Mains cable
- Operating manual



HD-Camera F2 Pro

300-001-601V





3-Chip Camera F4

300-001-804V

Features:

- Full HD-Camera with latest 3-MOS technology for brilliant picture quality
- Pure Natural Colors technology
- Multitude of digital video outputs for best possible picture transmission to medical grade monitors
- Ergonomic camera head with 3 programmable remote control buttons
- User-friendly multilingual menu allows a large variety of setups for individual procedures and surgeons preferences
- Full HD 60fps video recording
- Full HD image saving
- USB pen drive included
- Text generator (optional with keyboard)
- Documentation System



Delivery contains:

- Main Unit
- Camera head
- HDMI-DVI cable
- HDMI cable
- S-Video cable
- USB Pen Drive
- Mains cable
- Operating manual



3-MOS Camera Head
(included)

300-001-802



TV Coupler for SPiTZ Camera Devices



TV Coupler, manual lock, C-mount, soakable, FULL HD

f=14mm	300-001-813
f=25mm	300-001-814
f=28mm	300-001-815



Zoom TV Coupler, C-mount, soakable, FULL HD

f=15 - 36mm	250-015-036
-------------	-------------



LUMEN LED 1 Light Source

300-900-180V



Automatic or manual light intensity control



Features:

- Daylight quality
- 20.000h lamp lifetime
- Manual or automatic light control
- Waterproof touch control panel
- Low heat conduction by improved LED technology

Delivery contains:

- Main Unit
- BNC cable
- Mains cable
- Operating manual



Digital light intensity display

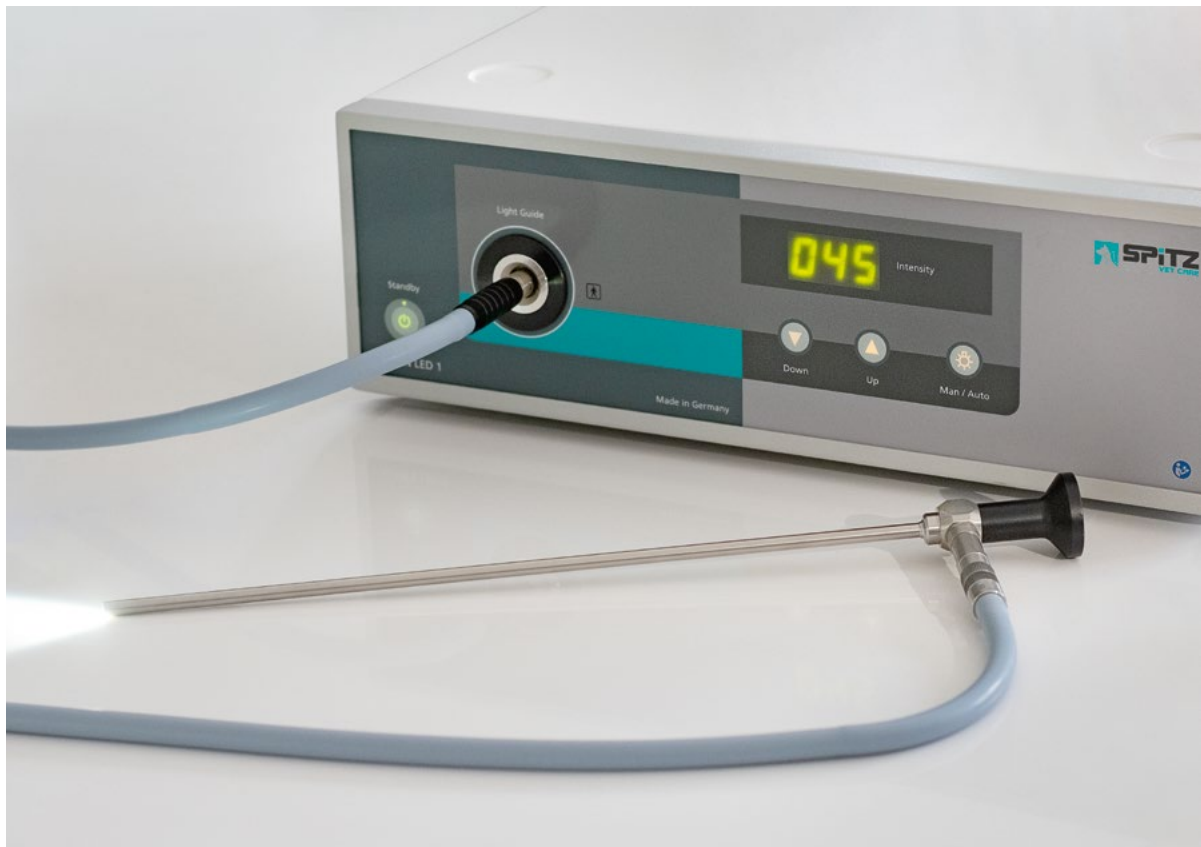



Fiber optic light cable, without adapter pieces

∅ 2.5mm, 2300mm	250-025-230
∅ 2.5mm, 3000mm	250-025-300
∅ 3.5mm, 1800mm	250-035-180
∅ 3.5mm, 2300mm	250-035-230
∅ 3.5mm, 3000mm	250-035-300
∅ 4.8mm, 1800mm	250-048-130
∅ 4.8mm, 2300mm	250-048-230
∅ 4.8mm, 3000mm	250-048-300



A



B



C



D



I



E



F



J



G



H



K



Adapter pieces for fiber light cable for use with light source

A SPiTZ/Storz	250-039-000
B Wolf	250-037-000
C ACMI/British Standard/CUDA	250-041-000
D Olympus	250-044-000
E Luxtec	250-048-000
F Heine	250-052-000
G Stryker	250-051-000
H Pentax	250-059-000



Adapter pieces for fiber light cable for use with telescope

I SPiTZ/Storz/Olympus	250-042-000
J Wolf	250-040-000
K ACMI/British Standard	250-041-000



LAP Suction and Irrigation Pump P1000
complete set

300-000-100V



Special filters ensure
sterility



Digital display shows
actual suction and
irrigation pressures

Features:

- Independently digital pre-setting for maximum suction and irrigation pressures
- Digital display of actual suction and irrigation pressures
- High efficiency with rates up to 3 L/minute
- Color coded tubing sets
- Skid-proof pedestals
- Standby function
- Low noise level
- Optional footswitch for comfortable operation during surgery
- Hydrophobic disposable filters for maximum patient safety
- Stainless steel housing for maximum lifetime

Delivery contains:

- Main Unit
- Suction and Irrigation Tubing Set
- Aspiration Bottle, 2L
- 2 Retainers with screws
- Puncture tube, 235mm
- 2 Hydrophobic filters, sterile
- Mains Cable
- 2 Spare Fuses
- Operating Manual



Pump P1, 110 - 230V

For Arthroscopy	225-906-000V
Irrigation Tubing Set, silicone, autoclavable (included)	225-910-001
Irrigation Tubing Set, PVC, 20 pcs. daily tube, sterile (optional)	225-910-002
Patient Tube, PVC, 40 pcs., sterile (optional)	225-910-003

Features:

- Hydrostatic pressure regulation
- Silicone Tubing Set included (225-910-001)
- Easy to operate, splash-proofed display
- Highly reliable tube guide and handling
- Skid-proof pedestals

Delivery contains:

- Main Unit
- Tubing Set
- Mains cable
- 2 Spare Fuses
- Operating manual



Airflow A2 Insufflation Device

Features:

- User-friendly interface
- Highest safety standard for patients
- Pre-insufflation mode for use with Veress Cannulas
- High gasflow rates

Delivery contains:

- Main Unit
- Sterile Filter 300-902-007
- Wrench Set 300-902-006
- CO₂ High Pressure Tube 300-902-003
- Standard Silicone Tube 300-902-005
- Mains Cable
- Operating Manual



Airflow A2

300-900-020V





Sterile Filter

300-902-007



Wrench Set (SW30/SW17)

300-902-006



CO₂ High Pressure Tube

300-902-003



Standard Silicone Tube

300-902-005



CO₂ Bottle, 0.75kg, empty (optional available)

300-902-008

Arthroscopy Shaver System STUNNER S1



Features:

- Open window calibration of shaver blades
- 9 oscillation modes
- Controlled by buttons on the handpiece or by footswitch
- Fully autoclavable, small and ergonomic handpiece
- Dedicated shaver blades

STUNNER S1 Unit,
complete with Hand Piece and Footswitch,
110 - 230V

[227-001-110V](#)

Control Unit

[227-001-101V](#)

Hand Piece

[227-001-102V](#)

Footswitch

[227-001-103V](#)



Shaver Blades



DR PitBull Shaver Blades
The universal blade for soft and hard tissue



DR WAVER Cutter Shaver Blades
The perfect blade for soft tissue resection

Non-sterile, 85mm working length

Ø 3.0mm 227-016-013

130mm working length

Ø 3.0mm 227-016-113

Ø 4.0mm 227-016-114

Non-sterile, 85mm working length

Ø 2.0mm 227-016-002

Ø 3.0mm 227-016-003

130mm working length

Ø 3.0mm 227-016-103

Ø 4.0mm 227-016-104



Lithotripter

Features:

- The smallest probe diameter is only 0.6mm, which ensures a larger lumen
- Auxiliary instruments can also be inserted
- Very simple handling, all parts are easy to disassemble for cleaning purposes
- Compatible to SPiTZ and other instruments for the therapy of ureteric, renal and bladder stones
- Non-conductive hand piece to ensure safety for patients as well as users against current conduct



Lithotripter L100

253-750-100V





Litho Probe, 605mm working length

0.6mm	253-850-006
0.8mm	253-850-005
1.0mm	253-850-010
1.6mm	253-850-016
2.0mm, 450mm WL	253-850-020
2.5mm, 450mm WL	253-850-025



Footswitch

253-750-150



Hand piece, anodized

253-750-200



Air compressor, 4 bar maximum

(optional)

253-750-010



Delivery contains:

- Main Unit
- Mains Cable
- Operating Manual

Medical Monitors



27" TFT monitor with LED
backlight, tiltable
1920 x 1800 pixel
HDMI, DP & VGA

300-001-161



24" TFT monitor with glass
1920 x 1800 pixel
HDMI, DVI, VGA & Display Port

300-001-162

Trolleys



**INDIVIDUAL
CONFIGURATION
POSSIBLE**



High-End Trolley

300-002-001

DIMENSIONS
1600 x 500 x 625mm
Rollers: Ø 125mm



Basic Trolley

300-001-999

