

index.

scissors.	3 - 20
dressing & tissue forceps.	21 - 34
clamps and forceps.	35 - 46
needle holders.	47 - 58
retractors.	59 - 68
skin and wound.	69 - 74
orthopaedics.	75 - 110
ENT.	111 - 118





scissors.





Fig. 1



Fig. 2

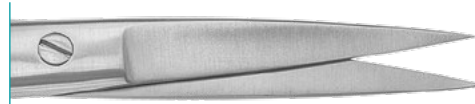

Fig. 3

**STANDARD****Fig. 1 (blunt/blunt), straight**

115mm, 4 ¹ / ₂ "	120-010-115
130mm, 5 ¹ / ₈ "	120-010-130
145mm, 5 ³ / ₄ "	120-010-145
155mm, 6 ¹ / ₈ "	120-010-155
165mm, 6 ¹ / ₂ "	120-010-165
175mm, 6 ⁷ / ₈ "	120-010-175
185mm, 7 ¹ / ₄ "	120-010-185
200mm, 8"	120-010-200

curved

115mm, 4 ¹ / ₂ "	120-011-115
130mm, 5 ¹ / ₈ "	120-011-130
145mm, 5 ³ / ₄ "	120-011-145
155mm, 6 ¹ / ₈ "	120-011-155
165mm, 6 ¹ / ₂ "	120-011-165
175mm, 6 ⁷ / ₈ "	120-011-175
185mm, 7 ¹ / ₄ "	120-011-185
200mm, 8"	120-011-200

Fig. 2 (sharp/blunt), straight

115mm, 4 ¹ / ₂ "	120-012-115
130mm, 5 ¹ / ₈ "	120-012-130
145mm, 5 ³ / ₄ "	120-012-145
155mm, 6 ¹ / ₈ "	120-012-155
165mm, 6 ¹ / ₂ "	120-012-165
175mm, 6 ⁷ / ₈ "	120-012-175
185mm, 7 ¹ / ₄ "	120-012-185
200mm, 8"	120-012-200

curved

115mm, 4 ¹ / ₂ "	120-013-115
130mm, 5 ¹ / ₈ "	120-013-130
145mm, 5 ³ / ₄ "	120-013-145
155mm, 6 ¹ / ₈ "	120-013-155
165mm, 6 ¹ / ₂ "	120-013-165
175mm, 6 ⁷ / ₈ "	120-013-175
185mm, 7 ¹ / ₄ "	120-013-185
200mm, 8"	120-013-200

Fig. 3 (sharp/sharp), straight

115mm, 4 ¹ / ₂ "	120-014-115
130mm, 5 ¹ / ₈ "	120-014-130
145mm, 5 ³ / ₄ "	120-014-145
155mm, 6 ¹ / ₈ "	120-014-155
165mm, 6 ¹ / ₂ "	120-014-165

curved

115mm, 4 ¹ / ₂ "	120-015-115
130mm, 5 ¹ / ₈ "	120-015-130
145mm, 5 ³ / ₄ "	120-015-145
155mm, 6 ¹ / ₈ "	120-015-155
165mm, 6 ¹ / ₂ "	120-015-165



MAYO
straight

145mm, 5 ³ / ₄ "	120-030-145
150mm, 6"	120-030-150
170mm, 6 ² / ₃ "	120-030-170

curved

145mm, 5 ³ / ₄ "	120-031-145
150mm, 6"	120-031-150
170mm, 6 ² / ₃ "	120-031-170



MAYO STILLE
straight

150mm, 6"	120-036-150
170mm, 6 ² / ₃ "	120-036-170
195mm, 7 ³ / ₄ "	120-036-195
210mm, 8 ¹ / ₄ "	120-036-210

curved

150mm, 6"	120-037-150
170mm, 6 ² / ₃ "	120-037-170
195mm, 7 ³ / ₄ "	120-037-195
210mm, 8 ¹ / ₄ "	120-037-210

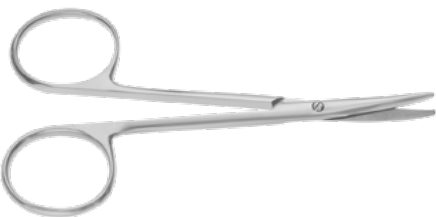

BABY METZENBAUM
straight

115mm, 4 ¹ / ₂ "	120-110-115
--	-------------

curved

115mm, 4 ¹ / ₂ "	120-111-115
--	-------------



METZENBAUM
straight

145mm, 5 ³ / ₄ "	120-110-145
160mm, 6 ¹ / ₄ "	120-110-160

curved

145mm, 5 ³ / ₄ "	120-111-145
160mm, 6 ¹ / ₄ "	120-111-160

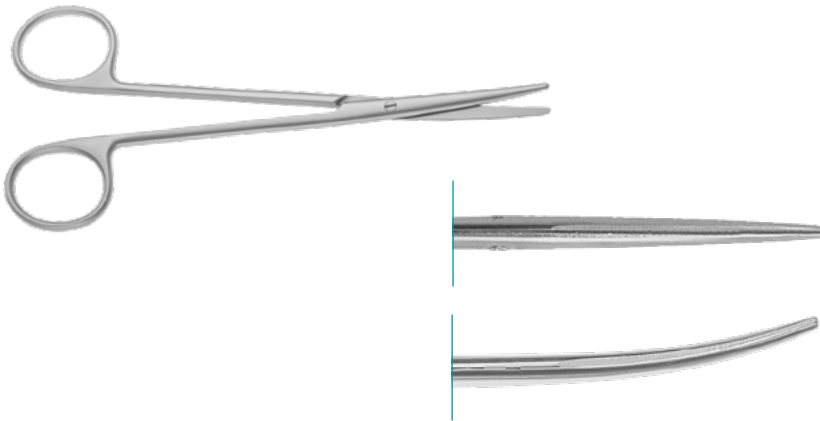
**METZENBAUM FINO****straight**

145mm, 5 ³ / ₄ "	120-152-145
180mm, 7"	120-152-180
200mm, 8"	120-152-200
230mm, 9"	120-152-230

curved

145mm, 5 ³ / ₄ "	120-153-145
180mm, 7"	120-153-180
200mm, 8"	120-153-200
230mm, 9"	120-153-230

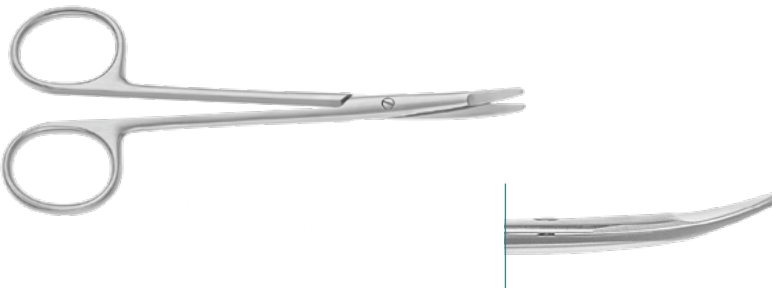
**KILNER RAGNELL****curved, blunt**

130mm, 5 ¹ / ₈ "	120-065-130
150mm, 6"	120-065-150
180mm, 7"	120-065-180
200mm, 8"	120-065-200
230mm, 9"	120-065-230

**JAMESON****curved, blunt**

150mm, 6"	120-315-150
180mm, 7"	120-315-180
200mm, 8"	120-315-200
230mm, 9"	120-315-230



LISTER
Bandage Scissors

90mm, 3 ¹ / ₂ "	190-165-090
110mm, 4 ¹ / ₃ "	190-165-110
140mm, 5 ¹ / ₂ "	190-165-140
180mm, 7"	190-165-180
200mm, 8"	190-165-200



LISTER
Bandage Scissors with 1 large ring

210mm, 8 ¹ / ₄ "	190-170-210
--	-------------



BERGMANN
Plaster Scissors

230mm, 9"	190-195-230
-----------	-------------





UNIVERSAL
small, 140mm, 5 1/2"

black	190-209-151
red	190-209-152
yellow	190-209-153
green	190-209-154



UNIVERSAL
large, 180mm, 7"

blue	190-209-180
black	190-209-181
red	190-209-182
yellow	190-209-183
green	190-209-184
orange	190-209-185





SPENCER

Suture Scissors, straight

90mm, 3 ¹ / ₂ "	120-220-090
130mm, 5 ¹ / ₈ "	120-220-130

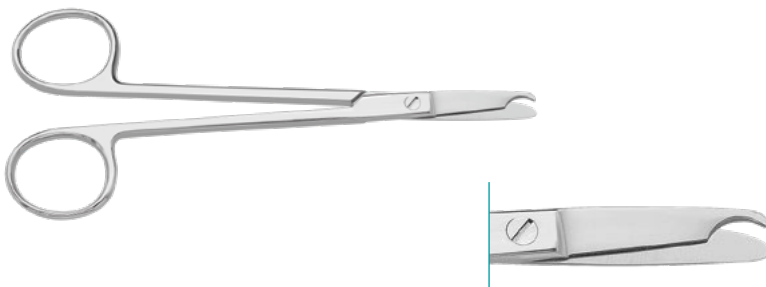

LITTAUER

Ligature Scissors, straight

115mm, 4 ¹ / ₂ "	120-224-115
140mm, 5 ¹ / ₂ "	120-224-140



Ligature Scissors, SC, TC inserts, curved, serrated blades

115mm, 4 ¹ / ₂ "	120-611-115
140mm, 5 ¹ / ₂ "	120-611-140
180mm, 7"	120-611-180
230mm, 9"	120-611-230



Iris Scissors, straight

90mm, 3 ¹ / ₂ "	120-070-090
105mm, 4 ¹ / ₈ "	120-070-105
115mm, 4 ¹ / ₂ "	120-070-115

curved

90mm, 3 ¹ / ₂ "	120-071-090
105mm, 4 ¹ / ₈ "	120-071-105
115mm, 4 ¹ / ₂ "	120-071-115



Iris Scissors, square model, 120mm, 4³/₄"

straight	120-086-120
curved	120-087-120



Iris Scissors, angled to side

115mm, 4 ¹ / ₂ "	120-085-115
--	-------------





Wire Cutting Scissors, serrated

120mm, 4³/₄" 120-265-120



HARVEY

Wire Cutting Scissors, both serrated blade, straight

125mm, 5" 120-262-125

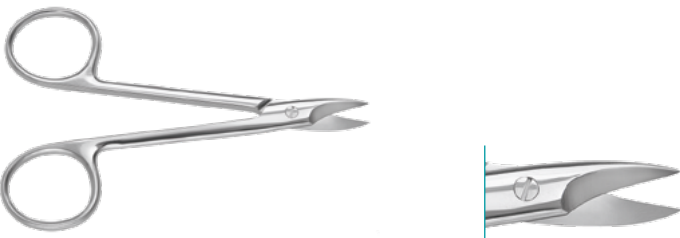

Crown & Collar Scissors, straight, serrated

100mm, 4" 120-296-100

120mm, 4³/₄" 120-296-120

curved

100mm, 4" 120-297-100

120mm, 4³/₄" 120-297-120

**Iris Scissors, 105mm, 4¹/₈"**

straight	120-080-105
curved	120-081-105

115mm, 4¹/₂"

straight	120-080-115
curved	120-081-115

KNAPP**Strabismus Scissors, blunt, 105mm, 4¹/₈"**

straight	400-112-105
curved	400-113-105

STEVENS**A Tenotomy Scissors, ring handle, blunt, straight**

105mm, 4 ¹ / ₈ "	120-092-105
115mm, 4 ¹ / ₂ "	120-092-115
125mm, 5"	120-092-125

B blunt, curved

90mm, 3 ¹ / ₂ "	120-093-090
105mm, 4 ¹ / ₈ "	120-093-105
115mm, 4 ¹ / ₂ "	120-093-115
125mm, 5"	120-093-125

C sharp, straight

105mm, 4 ¹ / ₈ "	120-090-105
115mm, 4 ¹ / ₂ "	120-090-115
125mm, 5"	120-090-125

D sharp, curved

105mm, 4 ¹ / ₈ "	120-091-105
115mm, 4 ¹ / ₂ "	120-091-115
125mm, 5"	120-091-125

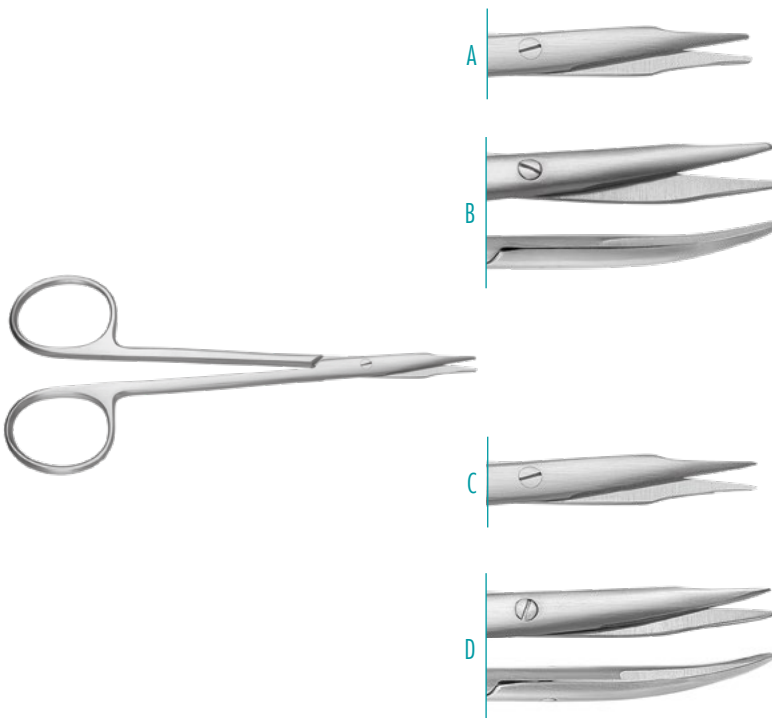

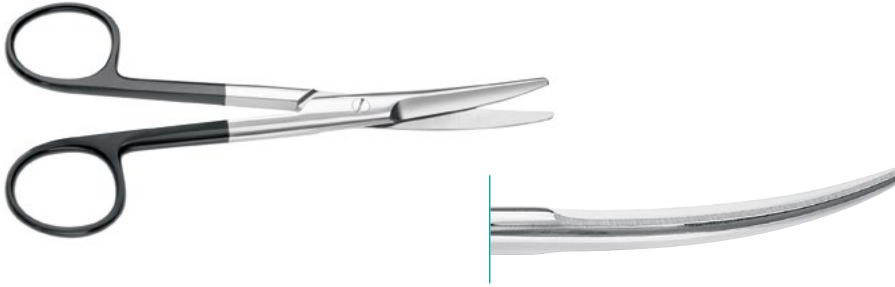

MAYO SC
Surgical Scissors, straight

145mm, 5 ³ / ₄ "	121-030-145
170mm, 6 ² / ₃ "	121-030-170
230mm, 9"	121-030-230

curved

145mm, 5 ³ / ₄ "	121-031-145
170mm, 6 ² / ₃ "	121-031-170
230mm, 9"	121-031-230

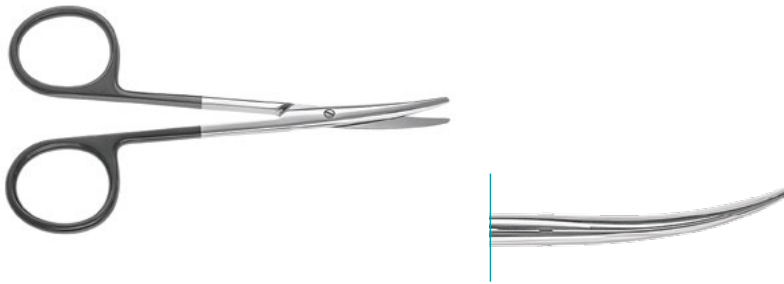

METZENBAUM BABY SC
Dissecting Scissors, curved

110mm, 4 ¹ / ₃ "	121-317-110
145mm, 5 ³ / ₄ "	121-317-145





STRABISMUS SC
Dissecting Scissors, 115mm, 4¹/₂"

straight	121-094-115
curved	121-095-115



METZENBAUM SC
145mm, 5³/₄"

straight	121-110-145
curved	121-111-145

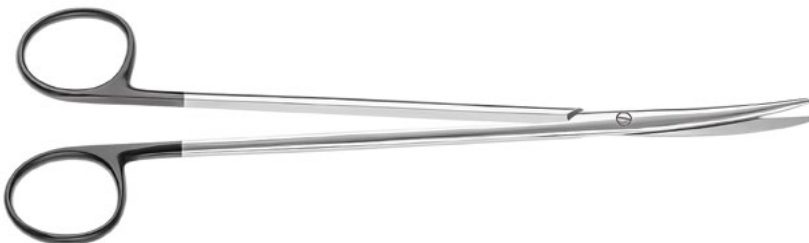

METZENBAUM FINO SC
curved, blunt

115mm, 4 ¹ / ₂ "	121-153-115
145mm, 5 ³ / ₄ "	121-153-145
180mm, 7"	121-153-180
200mm, 8"	121-153-200
230mm, 9"	121-153-230

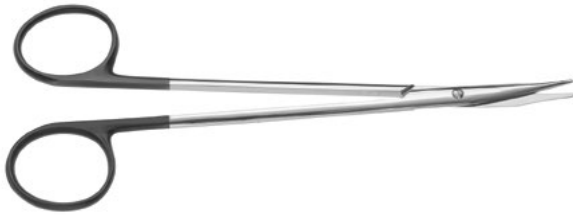

JAMESON SC
curved, blunt

150mm, 6"	121-315-150
180mm, 7"	121-315-180

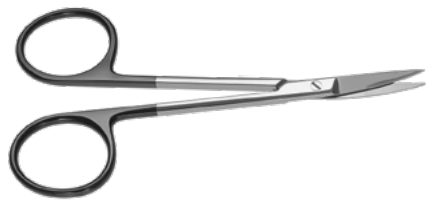

IRIS SC
sharp, 110mm, 4¹/₃"

straight	121-070-110
curved	121-071-110



STEVENS SC
Tenotomy Scissors, square model,
blunt, straight

105mm, 4 ¹ / ₈ "	121-196-100
115mm, 4 ¹ / ₂ "	121-196-110
125mm, 5"	121-196-120

curved

105mm, 4 ¹ / ₈ "	121-197-100
115mm, 4 ¹ / ₂ "	121-197-110
125mm, 5"	121-197-120

**STANDARD TC**straight, 145mm, 5³/₄"

Fig. 1 (blunt/blunt)	120-500-145
-------------------------	-------------

curved, 145mm, 5³/₄"

Fig. 1 (blunt/blunt)	120-501-145
-------------------------	-------------

straight, 145mm, 5³/₄"

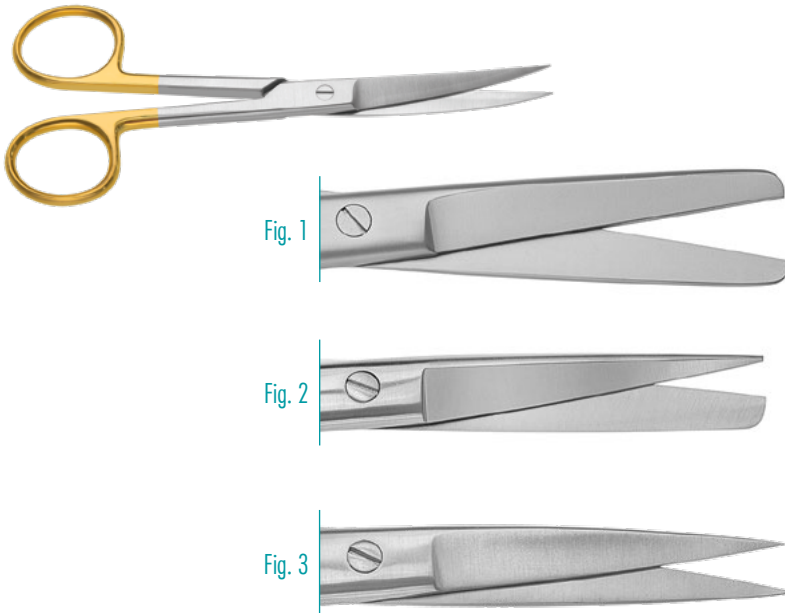
Fig. 2 (sharp/blunt)	120-502-145
-------------------------	-------------

Fig. 3 (sharp/sharp)	120-504-145
-------------------------	-------------

curved, 145mm, 5³/₄"

Fig. 2 (sharp/blunt)	120-503-145
-------------------------	-------------

Fig. 3 (sharp/sharp)	120-505-145
-------------------------	-------------

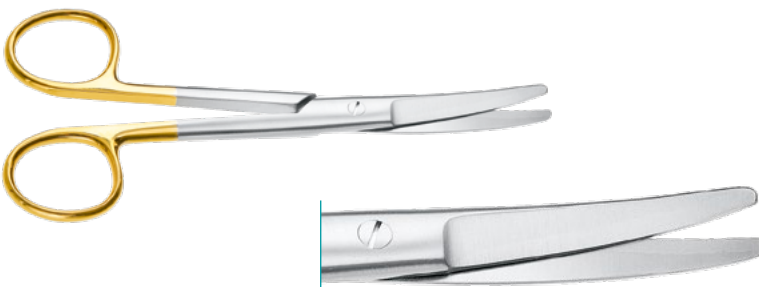
**MAYO TC**

straight

145mm, 5 ³ / ₄ "	120-506-145
--	-------------

170mm, 6 ² / ₃ "	120-506-170
--	-------------

curved

145mm, 5 ³ / ₄ "	120-507-145
--	-------------

170mm, 6 ² / ₃ "	120-507-170
--	-------------

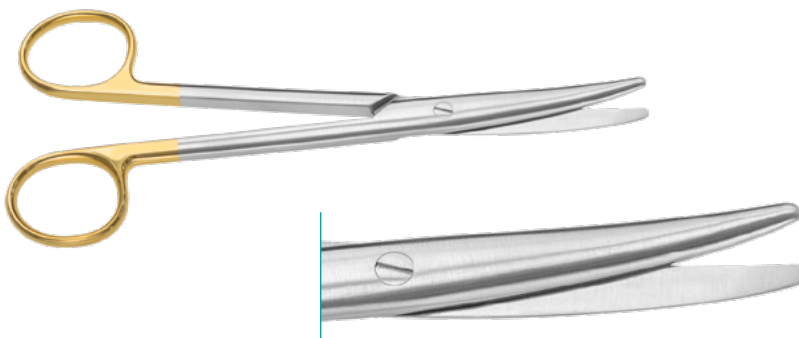
**MAYO STILLE TC**

straight

150mm, 6"	120-508-150
-----------	-------------

170mm, 6 ² / ₃ "	120-508-170
--	-------------

curved

150mm, 6"	120-509-150
-----------	-------------

170mm, 6 ² / ₃ "	120-507-170
--	-------------



TOENNIS ADSON TC

curved

170mm, 6²/₃"

120-531-170



METZENBAUM BABY TC

straight, blunt

115mm, 4¹/₂"

120-510-115

curved, blunt

115mm, 4¹/₂"

120-511-115



BABY METZENBAUM TC

Strabismus Scissors, straight

115mm, 4¹/₂"

120-594-115

curved

115mm, 4¹/₂"

120-595-115



METZENBAUM TC

straight, blunt/blunt

145mm, 5³/₄"

120-510-145

180mm, 7"

120-510-180

200mm, 8"

120-510-200

230mm, 9"

120-510-230

curved

145mm, 5³/₄"

120-511-145

180mm, 7"

120-511-180

200mm, 8"

120-511-200

230mm, 9"

120-511-230

**METZENBAUM FINO TC**

straight, blunt/blunt

145mm, 5 ³ / ₄ "	120-520-145
180mm, 7"	120-520-180
200mm, 8"	120-520-200
230mm, 9"	120-520-230

curved, blunt/blunt

145mm, 5 ³ / ₄ "	120-521-145
180mm, 7"	120-521-180
200mm, 8"	120-521-200
230mm, 9"	120-521-230

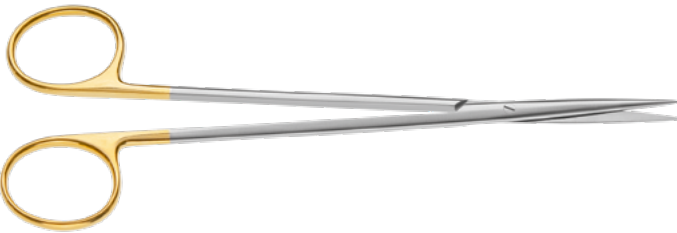
**METZENBAUM FINO TC**

straight, sharp/sharp

145mm, 5 ³ / ₄ "	120-522-145
180mm, 7"	120-522-180
200mm, 8"	120-522-200
230mm, 9"	120-522-230

curved, sharp/sharp

145mm, 5 ³ / ₄ "	120-523-145
180mm, 7"	120-523-180
200mm, 8"	120-523-200
230mm, 9"	120-523-230

straight, blunt

180mm, 7"	120-525-180
200mm, 8"	120-525-200

**IRIS TC**

straight

115mm, 4 ¹ / ₂ "	120-554-115
--	-------------

curved

115mm, 4 ¹ / ₂ "	120-555-115
--	-------------



STEVENS CERACUT®
Dissecting Scissors, straight, square rings
115mm, 4^{1/2}"

sharp	123-184-115
blunt	123-182-115



IRIS CERACUT®
115mm, 4^{1/2}"

straight	123-070-115
curved	123-071-115



BABY METZENBAUM CERACUT®
curved

110mm, 4 ^{1/3} "	123-317-110
145mm, 5 ^{3/4} "	123-317-145



MAYO CERACUT®
straight

145mm, 5 ^{3/4} "	123-030-145
170mm, 6 ^{2/3} "	123-030-170

curved

145mm, 5 ^{3/4} "	123-031-145
170mm, 6 ^{2/3} "	123-031-170



dressing & tissue forceps.



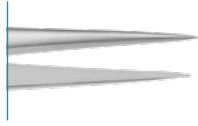

Delicate Forceps, smooth, straight

100mm, 4"	130-437-100
-----------	-------------



Delicate Forceps, smooth, angled

100mm, 4"	130-438-100
-----------	-------------



Plain Splinter Forceps

90mm, 3 1/2"	130-622-090
--------------	-------------

115mm, 4 1/2"	130-622-115
---------------	-------------



BISHOP HARMON

Iris Forceps, 1x 2 teeth, straight, 85mm, 3 1/3"

0.3mm	400-118-003
-------	-------------

0.4mm	400-118-004
-------	-------------

0.5mm	400-118-005
-------	-------------

0.8mm	400-118-008
-------	-------------

serrated

0.5mm	400-018-005
-------	-------------

0.8mm, cross-serrated	400-019-008
--------------------------	-------------



**Dressing Forceps, serrated**

105mm, 4 ¹ / ₈ "	130-010-105
115mm, 4 ¹ / ₂ "	130-010-115
130mm, 5 ¹ / ₈ "	130-010-130
145mm, 5 ³ / ₄ "	130-010-145
150mm, 6"	130-010-150
160mm, 6 ¹ / ₄ "	130-010-160
180mm, 7"	130-010-180
200mm, 8"	130-010-200
230mm, 9"	130-010-230
250mm, 9 ⁷ / ₈ "	130-010-250
300mm, 11 ⁷ / ₈ "	130-010-300

**Dressing Forceps, cross-serrated**

130mm, 5 ¹ / ₈ "	130-011-130
145mm, 5 ³ / ₄ "	130-011-145
160mm, 6 ¹ / ₄ "	130-011-160

**Standard Dressing Forceps,
slender, curved**

105mm, 4 ¹ / ₈ "	130-013-105
115mm, 4 ¹ / ₂ "	130-013-115
130mm, 5 ¹ / ₈ "	130-013-130
145mm, 5 ³ / ₄ "	130-013-145



STANDARD

Dressing Forceps, delicate tip, serrated

105mm, 4 ¹ / ₈ "	130-012-105
115mm, 4 ¹ / ₂ "	130-012-115
130mm, 5 ¹ / ₈ "	130-012-130
145mm, 5 ³ / ₄ "	130-012-145
160mm, 6 ¹ / ₄ "	130-012-160
180mm, 7"	130-012-180
200mm, 8"	130-012-200
250mm, 9 ⁷ / ₈ "	130-012-250
300mm, 11 ⁷ / ₈ "	130-012-300

Standard Dressing Forceps, delicate tip, serrated, curved

105mm, 4 ¹ / ₈ "	130-015-105
115mm, 4 ¹ / ₂ "	130-015-115
130mm, 5 ¹ / ₈ "	130-015-130
145mm, 5 ³ / ₄ "	130-015-145

POTTS SMITH

Dressing Forceps, straight

180mm, 7"	130-038-180
210mm, 8 ¹ / ₄ "	130-038-210
250mm, 9 ⁷ / ₈ "	130-038-250

curved

180mm, 7"	130-037-180
210mm, 8 ¹ / ₄ "	130-037-210
250mm, 9 ⁷ / ₈ "	130-037-250

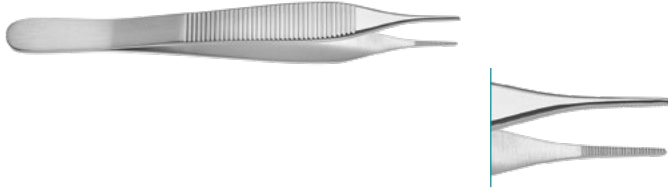

MICRO ADSON
Dressing Forceps, serrated

120mm, 4 ³ / ₄ "	130-548-120
150mm, 6"	130-548-150



ADSON
Dressing Forceps, smooth

120mm, 4 ³ / ₄ "	130-025-120
--	-------------

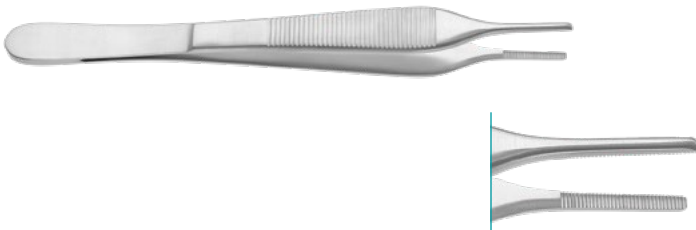

ADSON
Dressing Forceps, serrated

120mm, 4 ³ / ₄ "	130-026-120
150mm, 6"	130-026-150
180mm, 7"	130-026-180



ADSON
Dressing Forceps, cross-serrated

120mm, 4 ³ / ₄ "	130-029-120
--	-------------

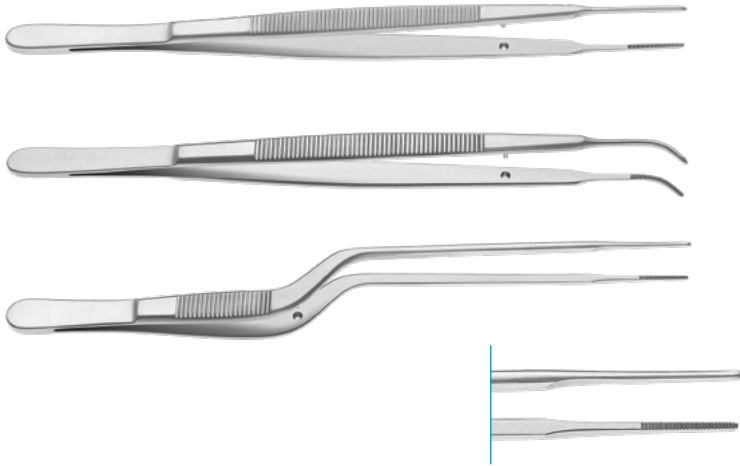

GERALD

Dressing Forceps, narrow,
1.2mm step-down-tip, serrated

Straight, 180mm, 7"	130-034-180
Straight, 230mm, 9"	130-034-230
Curved, 180mm, 7"	130-035-180
Curved, 230mm, 9"	130-035-230
Bayonet, 190mm, 7 ¹ / ₂ "	130-041-180



SEMKEN

Dressing Forceps, cross-serrated

125mm, 5"	130-144-125
150mm, 6"	130-144-150



TAYLOR

Dressing Forceps, bayonet,
serrated with dissector end

185mm, 7 ¹ / ₄ "	130-035-185
--	-------------



ADSON
Tissue Forceps, 1x2 teeth

120mm, 4 ³ / ₄ "	130-140-120
150mm, 6"	130-140-150
180mm, 7"	130-140-180

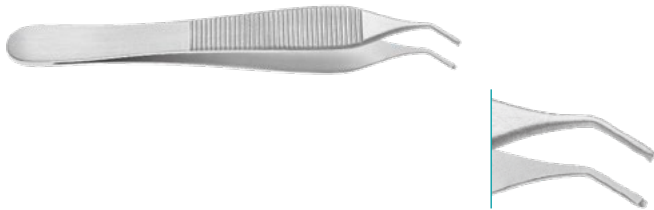

ADSON
Tissue Forceps, 1x2 teeth, angled

120mm, 4 ³ / ₄ "	130-143-120
--	-------------



MICRO ADSON
Tissue Forceps, 1x2 teeth, 0.8mm tip

120mm, 4 ³ / ₄ "	130-550-120
150mm, 6"	130-550-150



ADSON

Tissue Forceps, 1x2 teeth, with tying platform, 120mm, 4³/₄"

0.9mm tip	130-141-009
1.0mm tip	130-141-010
1.2mm tip	130-141-012



EWALD ADSON

Tissue Forceps, 1x2 teeth

120mm, 4 ³ / ₄ "	130-142-120
--	-------------



ADSON

Tissue Forceps, 2x3 teeth

120mm, 4 ³ / ₄ "	130-555-120
150mm, 6"	130-555-150

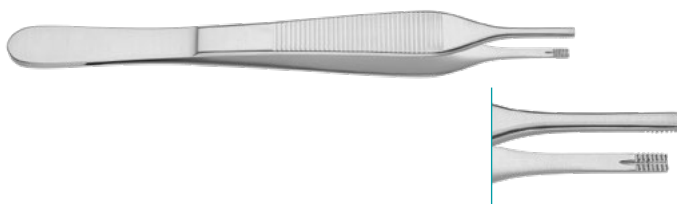

ADSON BROWN

Tissue Forceps, 7x7 teeth

120mm, 4 ³ / ₄ "	130-552-120
150mm, 6"	130-552-150



Tissue Forceps, 1x2 teeth

105mm, 4 ¹ / ₈ "	130-110-105
115mm, 4 ¹ / ₂ "	130-110-115
130mm, 5 ¹ / ₈ "	130-110-130
145mm, 5 ³ / ₄ "	130-110-145
150mm, 6"	130-110-150
160mm, 6 ¹ / ₄ "	130-110-160
180mm, 7"	130-110-180
200mm, 8"	130-110-200
230mm, 9"	130-110-230
250mm, 9 ⁷ / ₈ "	130-110-250
300mm, 11 ⁷ / ₈ "	130-110-300



Tissue Forceps, 1x2 teeth, delicate

115mm, 4 ¹ / ₂ "	130-120-115
130mm, 5 ¹ / ₈ "	130-120-130
145mm, 5 ³ / ₄ "	130-120-145
160mm, 6 ¹ / ₄ "	130-120-160
180mm, 7"	130-120-180
200mm, 8"	130-120-200
250mm, 9 ⁷ / ₈ "	130-120-250
300mm, 11 ⁷ / ₈ "	130-120-300



Tissue Forceps

2x3teeth, 145mm, 5 ³ / ₄ "	130-112-145
2x3teeth, 160mm, 6 ¹ / ₄ "	130-112-160
3x4teeth, 145mm, 5 ³ / ₄ "	130-114-145
3x4teeth, 160mm, 6 ¹ / ₄ "	130-114-160
4x5teeth, 145mm, 5 ³ / ₄ "	130-116-145
4x5teeth, 160mm, 6 ¹ / ₄ "	130-116-160



Tissue Forceps, 1x2 teeth, delicate

145mm, 5 ³ / ₄ "	130-118-145
155mm, 6 ¹ / ₈ "	130-118-155
160mm, 6 ¹ / ₄ "	130-118-160
180mm, 7"	130-118-180



GERALD

**Tissue Forceps, narrow, 1.3mm step-down tip
1x2 teeth**

Straight, 180mm, 7"	130-150-180
Straight, 230mm, 9"	130-150-230
Curved, 180mm, 7"	130-151-180
Bayonet, 195mm, 7 ³ / ₄ "	130-153-195



SEMKEN

Tissue Forceps

1x2teeth, 125mm, 5"	130-145-125
1x2teeth, 150mm, 6"	130-145-150
2x3teeth, 125mm, 5"	130-147-125



GILLIES

Tissue Forceps, 1x2 teeth, cross-serrated

150mm, 6"	130-120-150
-----------	-------------





TC Dressing Forceps

145mm, 5 ³ / ₄ "	130-518-145
160mm, 6 ¹ / ₄ "	130-518-160

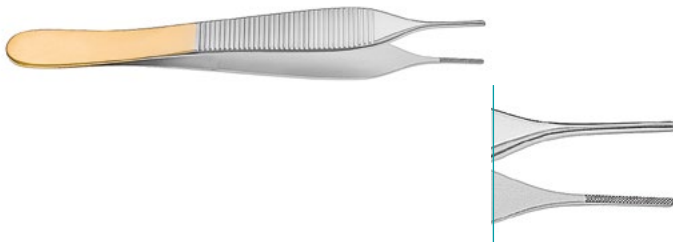

TC MICRO ADSON Dressing Forceps, serrated

120mm, 4 ³ / ₄ "	130-538-120
--	-------------

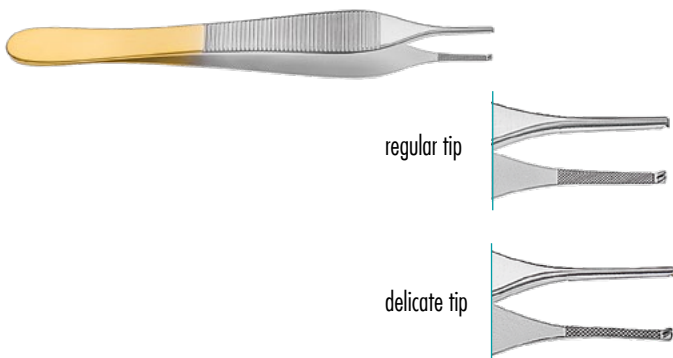

TC ADSON Needle and Tissue Pulling Forceps, with tying platform, 1x2 teeth, cross-serrated, regular tip

120mm 4 ³ / ₄ "	130-534-120
150mm, 6"	130-534-150

delicate tip

120mm 4 ³ / ₄ "	130-537-120
150mm, 6"	130-537-150



TC ADSON BROWN Tissue Forceps, 7x7 teeth, tying platform

120mm, 4 ³ / ₄ "	130-529-120
150mm, 6"	130-529-150



TC ADSON Dressing Forceps, serrated

120mm, 4 ³ / ₄ "	130-532-120
150mm, 6"	130-532-150

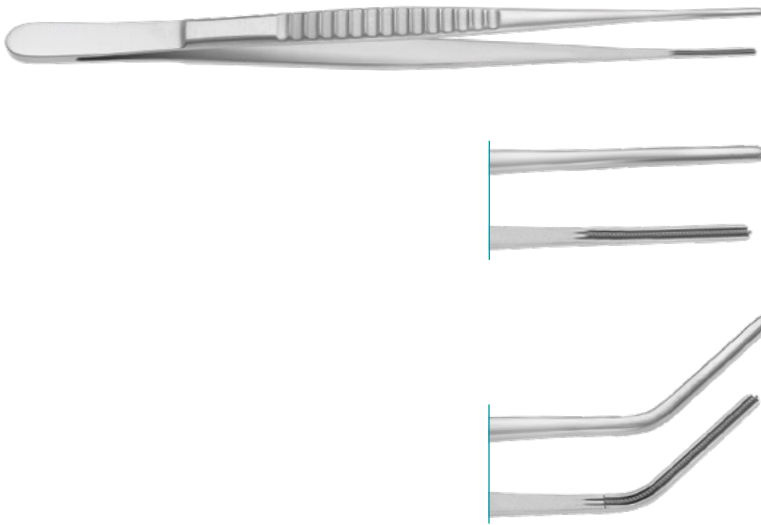

DEBAKEY

Vascular Atraumatic Forceps, straight,
2.0mm tip, 24mm DeBaKEY serrations

160mm, 6 ¹ / ₄ "	290-552-160
200mm, 8"	290-552-200
240mm, 9 ¹ / ₂ "	290-552-240
300mm, 11 ⁷ / ₈ "	290-552-300

angled

160mm, 6 ¹ / ₄ "	290-553-160
200mm, 8"	290-553-200
240mm, 9 ¹ / ₂ "	290-553-240
300mm, 11 ⁷ / ₈ "	290-553-300



DEBAKEY

Vascular Atraumatic Forceps, straight,
2.4mm tip, 24mm DeBaKEY serrations

160mm, 6 ¹ / ₄ "	290-557-160
200mm, 8"	290-557-200
240mm, 9 ¹ / ₂ "	290-557-240
300mm, 11 ⁷ / ₈ "	290-557-300



DEBAKEY

Vascular Atraumatic Forceps, straight,
3.5mm step-down tip,
24mm DeBaKEY serrations

160mm, 6 ¹ / ₄ "	290-555-160
200mm, 8"	290-555-200
240mm, 9 ¹ / ₂ "	290-555-240
300mm, 11 ⁷ / ₈ "	290-555-300

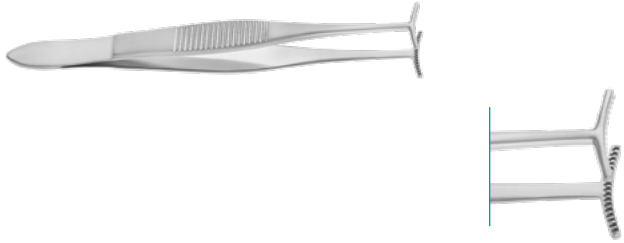

GREEN
Fixation Forceps, 12mm wide jaw,
fine serrations

110mm, 4¹/₃" 400-029-012



GRAEFE
Fixation Forceps, 7x8 teeth

110mm, 4¹/₃" 400-025-110





clamps and forceps.





MICRO HALSTEAD MOSQUITO

Hemostatic Forceps, straight

100mm, 4"	140-270-100
120mm, 4 ³ / ₄ "	140-270-120

curved

100mm, 4"	140-271-100
120mm, 4 ³ / ₄ "	140-271-120

straight, 1x2 teeth

100mm, 4"	140-272-100
120mm, 4 ³ / ₄ "	140-272-120

curved, 1x2teeth

100mm, 4"	140-273-100
120mm, 4 ³ / ₄ "	140-273-120

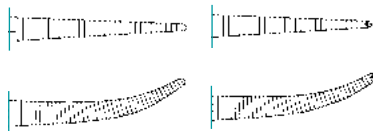
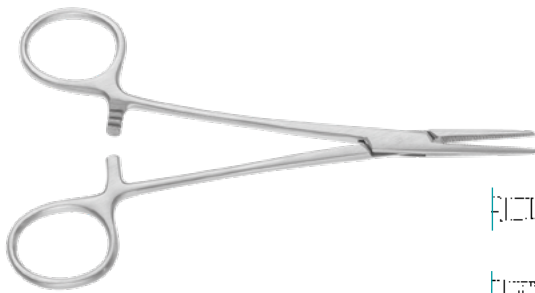

HALSTEAD MOSQUITO

Hemostatic Forceps, serrated, straight

125mm, 5"	140-254-125
140mm, 5 ¹ / ₂ "	140-254-140
180mm, 7"	140-254-180
210mm, 8 ¹ / ₄ "	140-254-210

serrated, curved

125mm, 5"	140-255-125
140mm, 5 ¹ / ₂ "	140-255-140
180mm, 7"	140-255-180
210mm, 8 ¹ / ₄ "	140-255-210

1x2 teeth, curved

125mm, 5"	140-257-125
140mm, 5 ¹ / ₂ "	140-257-140
180mm, 7"	140-257-180
210mm, 8 ¹ / ₄ "	140-257-210

1x2 teeth, straight

125mm, 5"	140-256-125
140mm, 5 ¹ / ₂ "	140-256-140
180mm, 7"	140-256-180
210mm, 8 ¹ / ₄ "	140-256-210

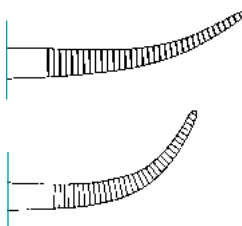

JACOBSON

Hemostatic Forceps, delicate, 0.3mm tip, curved

100mm, 4"	140-161-100
130mm, 5 ¹ / ₈ "	140-161-130
190mm, 7 ¹ / ₂ "	140-161-190

fully curved

130mm, 5 ¹ / ₈ "	140-162-130
190mm, 7 ¹ / ₂ "	140-162-190

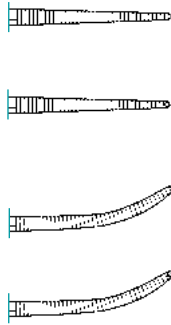

HARTMANN MOSQUITO

Hemostatic Forceps, serrated, straight

100mm, 4" 140-250-100

1x2 teeth, straight

100mm, 4" 140-248-100

serrated, curved

100mm, 4" 140-251-100

1x2 teeth, curved

100mm, 4" 140-249-100

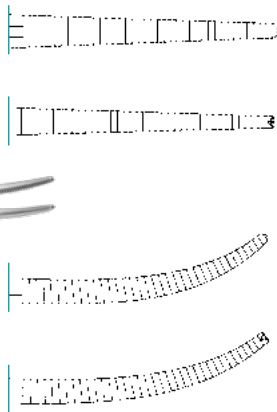

CRILE

Hemostatic Forceps, serrated, straight

140mm, 5 1/2" 140-290-140

1x2 teeth, straight

140mm, 5 1/2" 140-292-140

serrated, curved

140mm, 5 1/2" 140-291-140

1x2 teeth, curved

140mm, 5 1/2" 140-293-140

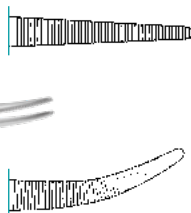

BABY CRILE

Hemostatic Forceps, 140mm, 5 1/2"

serrated, straight 140-334-140

serrated, curved 140-335-140

1x2 teeth, straight 140-336-140

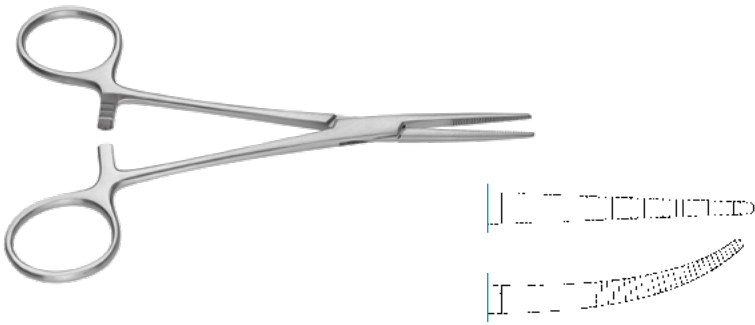
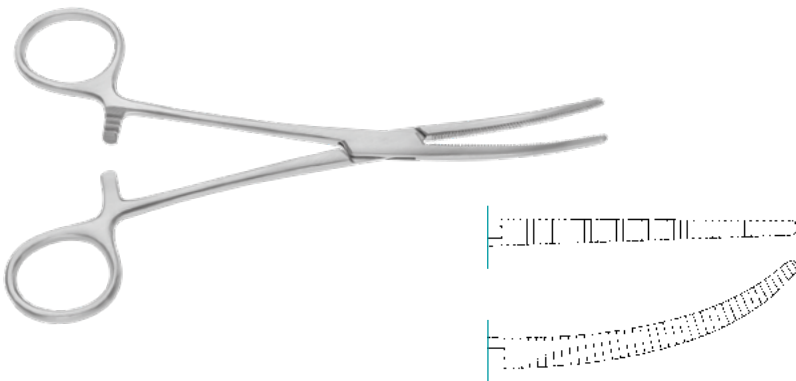
**KELLY****Hemostatic Forceps, straight**140mm, 5¹/₂" 140-280-140**curved**140mm, 5¹/₂" 140-281-140**ROCHESTER PEAN****Hemostatic Forceps, serrated, straight**140mm, 5¹/₂" 140-330-140160mm, 6¹/₄" 140-330-160

180mm, 7" 140-330-180

200mm, 8" 140-330-200

220mm, 8²/₃" 140-330-220240mm, 9¹/₂" 140-330-240260mm, 10¹/₄" 140-330-260300mm, 11⁷/₈" 140-330-300

355mm, 14" 140-330-355

curved140mm, 5¹/₂" 140-331-140160mm, 6¹/₄" 140-331-160

180mm, 7" 140-331-180

200mm, 8" 140-331-200

220mm, 8²/₃" 140-331-220240mm, 9¹/₂" 140-331-240260mm, 10¹/₄" 140-331-260300mm, 11⁷/₈" 140-331-300

355mm, 14" 140-331-355

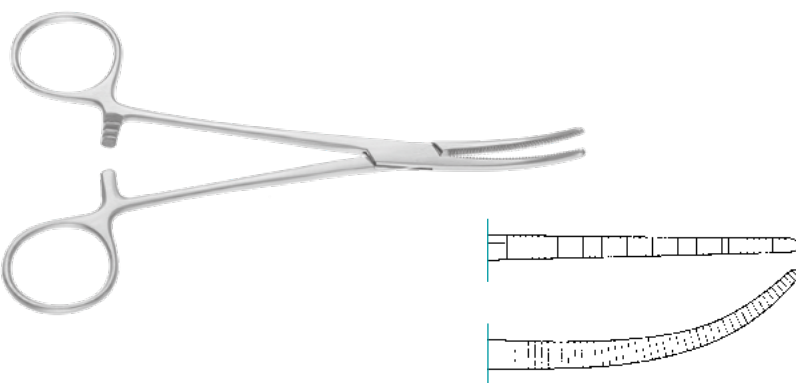
**PEAN****Hemostatic Forceps, delicate, serrated, straight**130mm, 5¹/₈" 140-316-130140mm, 5¹/₂" 140-316-140160mm, 6¹/₄" 140-316-160**curved**130mm, 5¹/₈" 140-317-130140mm, 5¹/₂" 140-317-140160mm, 6¹/₄" 140-317-160

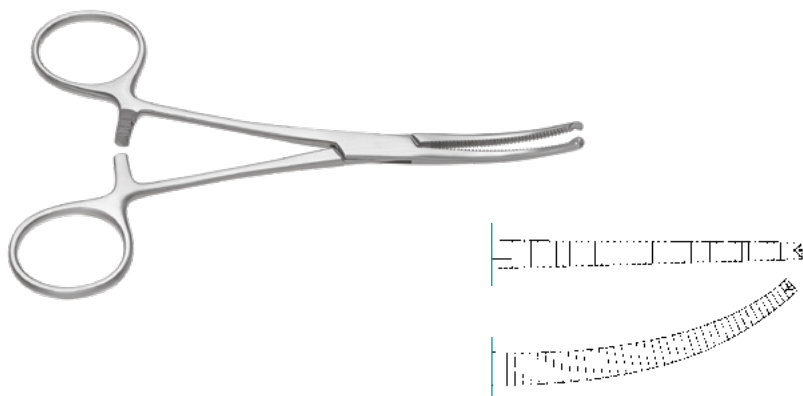

KOCHER OCHSNER

Hemostatic Forceps, 1x 2 teeth, straight

140mm, 5 ¹ / ₂ "	140-332-140
160mm, 6 ¹ / ₄ "	140-332-160
180mm, 7"	140-332-180
200mm, 8"	140-332-200
220mm, 8 ² / ₃ "	140-332-220
240mm, 9 ¹ / ₂ "	140-332-240
260mm, 10 ¹ / ₄ "	140-332-260
300mm, 11 ⁷ / ₈ "	140-332-300
355mm, 14"	140-332-355

curved

140mm, 5 ¹ / ₂ "	140-333-140
160mm, 6 ¹ / ₄ "	140-333-160
180mm, 7"	140-333-180
200mm, 8"	140-333-200
220mm, 8 ² / ₃ "	140-333-220
240mm, 9 ¹ / ₂ "	140-333-240
260mm, 10 ¹ / ₄ "	140-333-260
300mm, 11 ⁷ / ₈ "	140-333-300
355mm, 14"	140-333-355

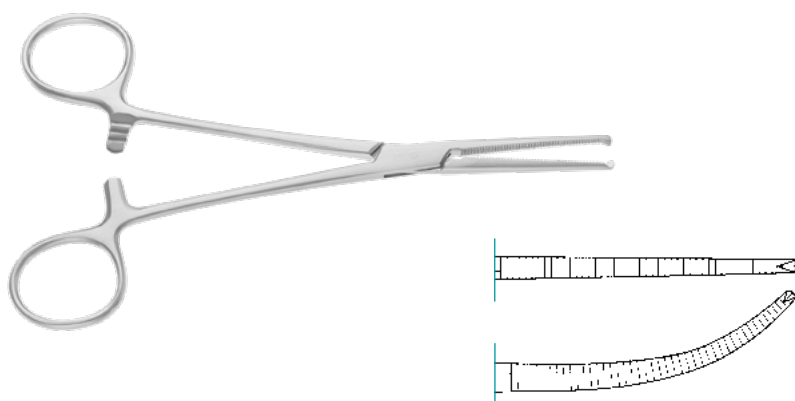

KOCHER

Delicate Hemostatic Forceps, 1x2 teeth, straight

130mm, 5 ¹ / ₈ "	140-318-130
140mm, 5 ¹ / ₂ "	140-318-140
160mm, 6 ¹ / ₄ "	140-318-160

curved

130mm, 5 ¹ / ₈ "	140-319-130
140mm, 5 ¹ / ₂ "	140-319-140
160mm, 6 ¹ / ₄ "	140-319-160



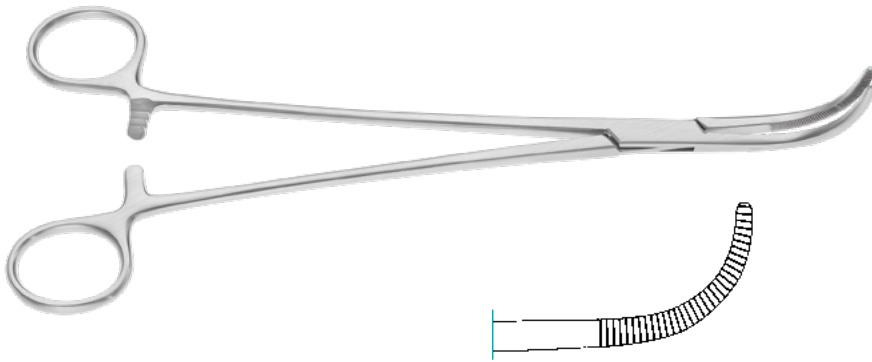

MIXTER
Dissecting and Ligature Forceps,
partially serrated

220mm, 8 ² / ₃ "	140-427-220
230mm, 9"	140-429-230

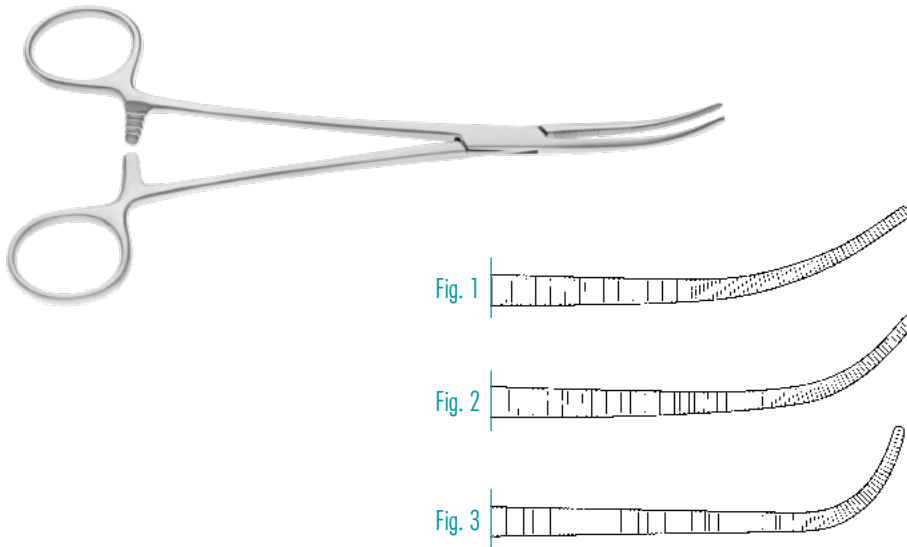

KELLY
Dissecting Forceps, fully serrated,
Fig. 1

190mm, 7 ¹ / ₂ "	140-633-190
220mm, 8 ² / ₃ "	140-633-220
240mm, 9 ¹ / ₂ "	140-633-240

Fig. 2

190mm, 7 ¹ / ₂ "	140-635-190
220mm, 8 ² / ₃ "	140-635-220
240mm, 9 ¹ / ₂ "	140-635-240

Fig. 3

190mm, 7 ¹ / ₂ "	140-637-190
220mm, 8 ² / ₃ "	140-637-220
240mm, 9 ¹ / ₂ "	140-637-240



BABY MIXTER
Dissecting and Ligature Forceps,
serrated, curved

140mm, 5 ¹ / ₂ "	140-421-140
--	-------------

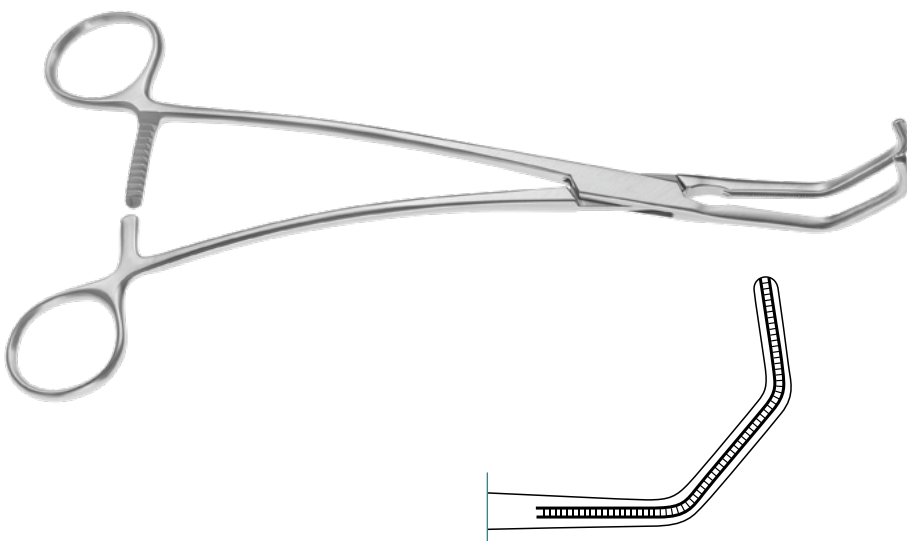

SATINSKY
Tangential Clamp

200mm, 8"	290-425-200
-----------	-------------

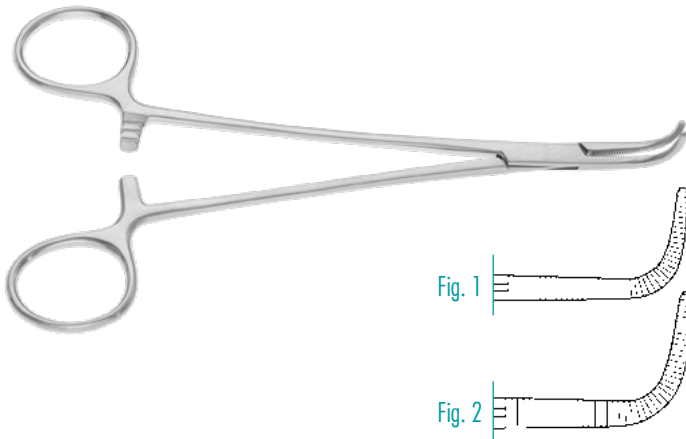

MEEKER

Kidney Pedicle Clamp, curved,
Fig. 1

180mm, 7" 140-619-180

Fig. 2

280mm, 11" 140-619-275

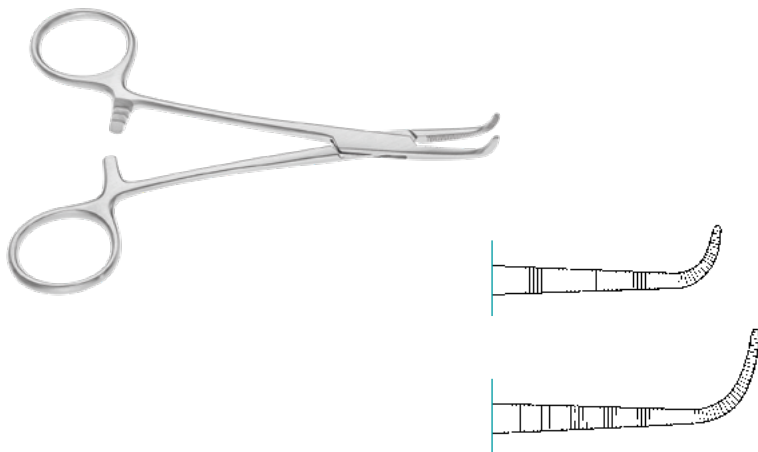

MINI GEMINI

Dissecting Forceps, fully serrated, curved

130mm, 5¹/₈" 140-359-130

160mm, 6¹/₄" 140-359-160

180mm, 7" 140-359-180

200mm, 8" 140-359-200

220mm, 8²/₃" 140-359-220

230mm, 9" 140-359-230

250mm, 9⁷/₈" 140-359-250

280mm, 11" 140-359-280

GEMINI

Dissecting Forceps, fully serrated, curved

130mm, 5¹/₈" 140-361-130

160mm, 6¹/₄" 140-361-160

180mm, 7" 140-361-180

200mm, 8" 140-361-200

220mm, 8²/₃" 140-361-220

230mm, 9" 140-361-230

250mm, 9⁷/₈" 140-361-250

280mm, 11" 140-361-280

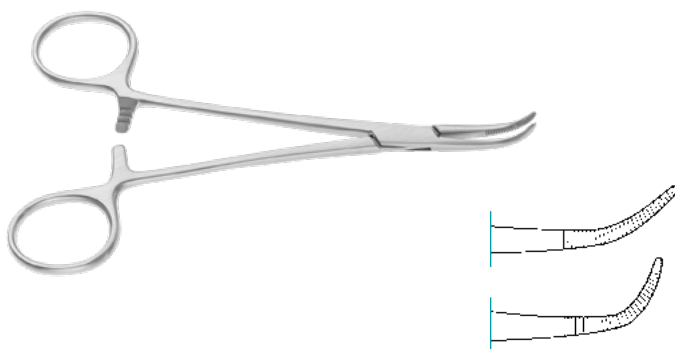

BABY MIXTER

Artery Forceps, slightly curved

140mm, 5¹/₂" 140-244-140

strongly curved

140mm, 5¹/₂" 140-245-140

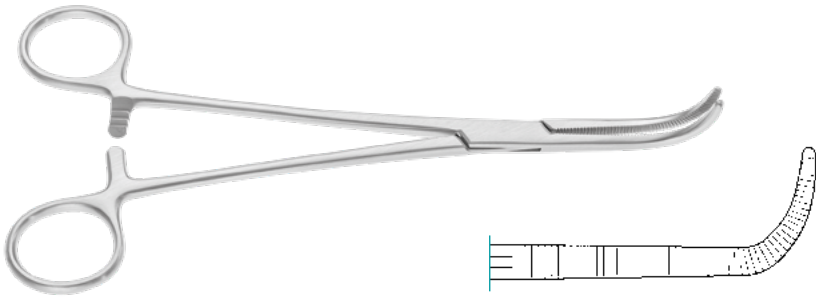

MIXTER
Forceps, fully serrated

155mm, 6 ¹ / ₈ "	140-423-155
190mm, 7 ¹ / ₂ "	140-423-190



PETIT ALLIS
Tissue Forceps, 2x3 teeth

120mm, 4 ³ / ₄ "	310-008-120
150mm, 6"	310-008-150

3x4 teeth

120mm, 4 ³ / ₄ "	310-009-120
150mm, 6"	310-009-150



ALLIS
Tissue Forceps, 7mm wide, 5x6 teeth

150mm, 6"	310-014-150
190mm, 7 ¹ / ₂ "	310-014-190
220mm, 8 ² / ₃ "	310-014-220
250mm, 9 ⁷ / ₈ "	310-014-250



JUDD ALLIS
Tissue Forceps, 3x4 teeth, 4mm wide

150mm, 6"	310-028-150
-----------	-------------

4.3mm wide

190mm, 7 ¹ / ₂ "	310-026-190
--	-------------



ALLIS ADAIR

Tissue Forceps, 9x10 teeth, 10mm wide

155mm, 6¹/₈" 310-027-155



BABCOCK

Tissue Forceps, 8mm wide

160mm, 6¹/₄" 310-110-160

10.5mm wide

180mm, 7" 310-110-180

11mm wide

200mm, 8" 310-110-200

11.8mm wide

240mm, 9¹/₂" 310-110-240

11.5mm wide

300mm, 11⁷/₈" 310-110-300

12mm wide

355mm, 14" 310-110-355

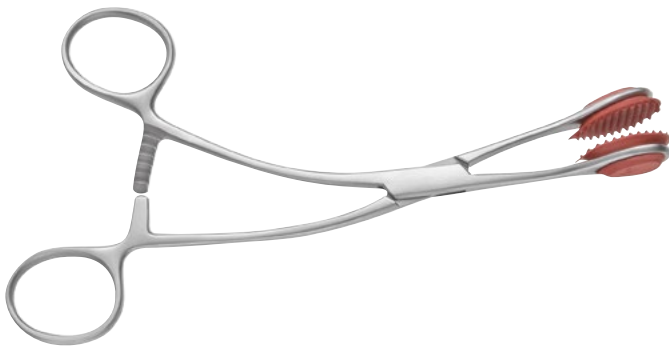

YOUNG

Tongue Holding Forceps

170mm, 6²/₃" 430-467-170



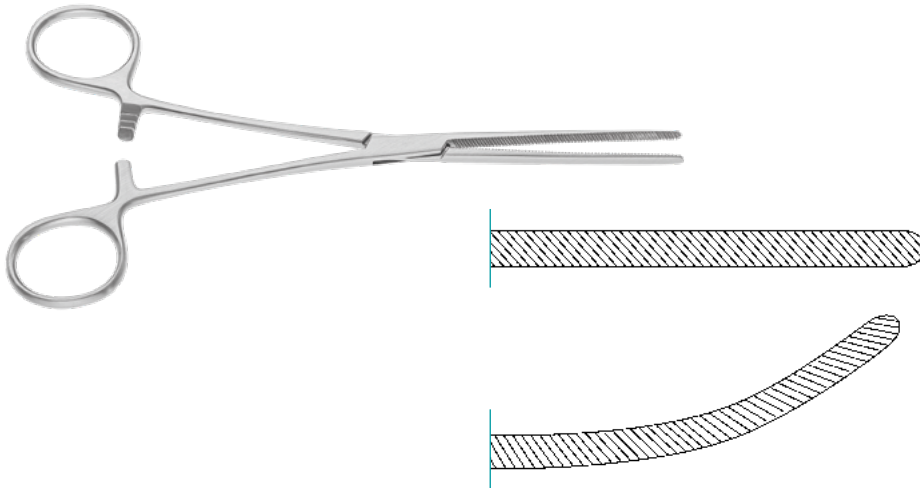

BABY DOYEN

Intestinal Clamp, diagonal serrations, elastic
180mm, 7"

straight	310-290-180
curved	310-291-180

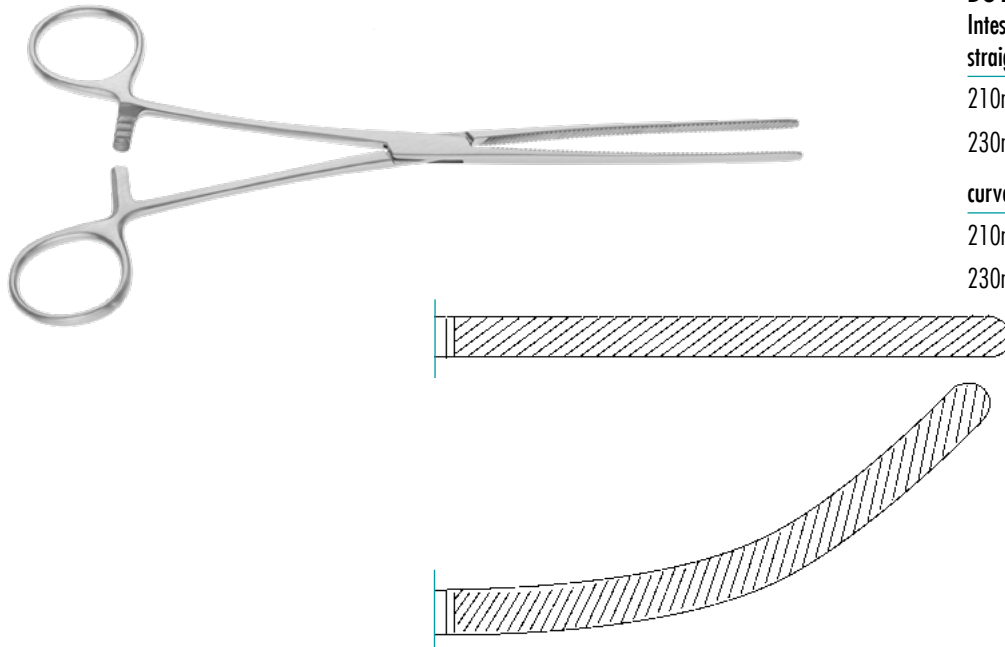

DOYEN

Intestinal Clamp, diagonal serrations, elastic,
straight

210mm, 8 ¹ / ₄ "	310-290-210
230mm, 9"	310-290-230

curved

210mm, 8 ¹ / ₄ "	310-291-210
230mm, 9"	310-291-230

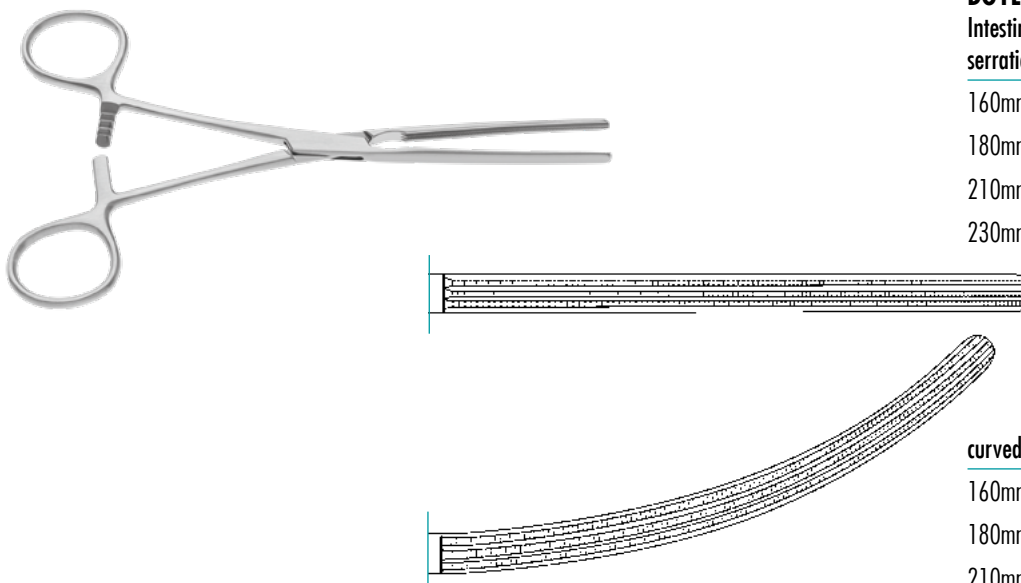

DOYEN ATRAUMATIC

Intestinal Clamp, atraumatic elastic
serrations, straight

160mm, 6 ¹ / ₄ "	310-550-160
180mm, 7"	310-550-180
210mm, 8 ¹ / ₄ "	310-550-210
230mm, 9"	310-550-230

curved

160mm, 6 ¹ / ₄ "	310-551-160
180mm, 7"	310-551-180
210mm, 8 ¹ / ₄ "	310-551-210
230mm, 9"	310-551-230



BACKHAUS
Towel Forceps

90mm, 3 ¹ / ₂ "	140-573-090
110mm, 4 ¹ / ₃ "	140-573-110
130mm, 5 ¹ / ₈ "	140-573-130
150mm, 6"	140-573-150



Ball & Socket Towel Forceps

110mm, 4 ¹ / ₃ "	140-580-115
130mm, 5 ¹ / ₈ "	140-580-130



PEERS
Towel Forceps, non-perforating

145mm, 5 ³ / ₄ "	140-595-145
--	-------------

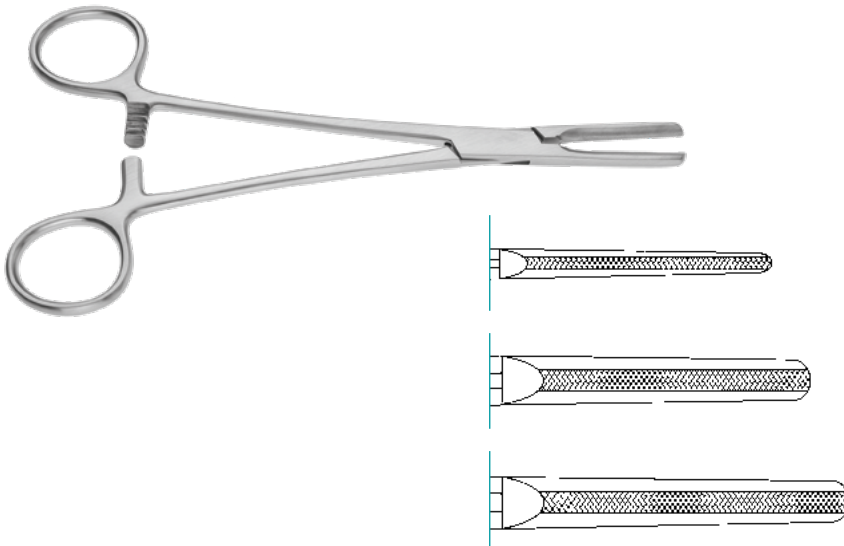

VORSE

Tubing Clamp, serrated jaws

150mm, 6"	140-603-150
180mm, 7"	140-603-180
200mm, 8"	140-603-200

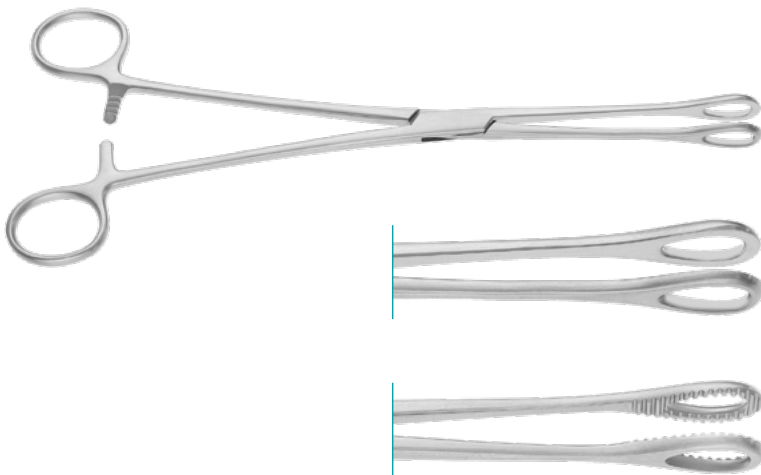

FOERSTER

Sponge Forceps, smooth, straight

180mm, 7"	150-050-180
200mm, 8"	150-050-200
250mm, 9 ⁷ / ₈ "	150-050-250

smooth, curved

180mm, 7"	150-053-180
200mm, 8"	150-053-200
250mm, 9 ⁷ / ₈ "	150-053-250

serrated, straight

180mm, 7"	150-052-180
200mm, 8"	150-052-200
250mm, 9 ⁷ / ₈ "	150-052-250
355mm, 14"	150-052-355
410mm, 16"	150-052-410

serrated, curved

180mm, 7"	150-055-180
200mm, 8"	150-055-200
250mm, 9 ⁷ / ₈ "	150-055-250

needle holders.

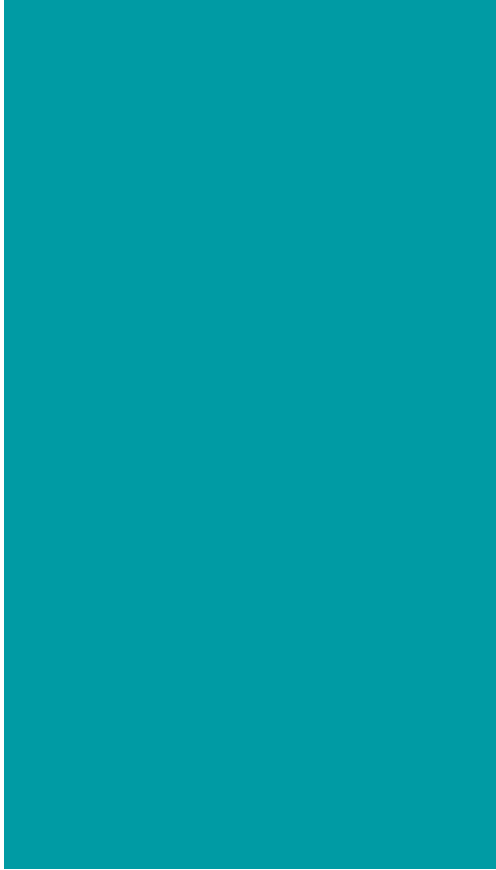



Needle Holders *without* Tungsten Carbide inserts



Standard serration for an optimal grip of the needle.

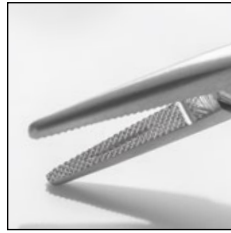

Standard serration with additional groove



Standard Ring Handle



Needle Holders *with* Tungsten Carbide inserts



Normal serration of 0.5 for use with sutures up to size 4-0

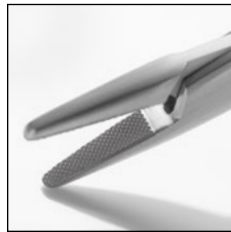

Fine serration of 0.4 for use with sutures up to size 5-0 / 6-0



Extra fine serration of 0.3 for use with sutures up to size 10-0



Smooth serration for use with sutures up to size 7-0 to 10-0

Mirror gold finished ring handle

Needle Holders with Diamond Dusted jaw



Diamond dusted coating of the jaw hardens the working surface, improves the durability and guarantees a tight grip of fine needles



Mirror finished ring handle





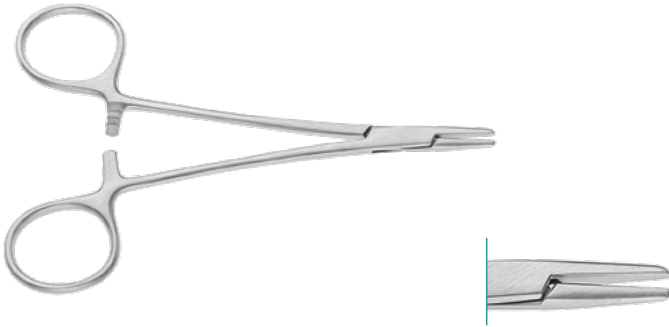

WEBSTER
Straight, smooth

130mm, 5¹/₈"

180-318-130



CONVERSE
Longitudinal serrated jaw, straight

125mm, 5"

180-310-125



DERF
Grooved serrated jaw, straight

120mm, 4³/₄"

180-310-120

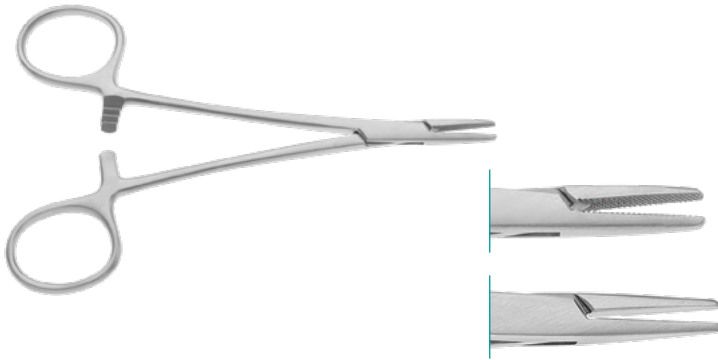

HALSEY

Cross serrated jaw, straight

130mm, 5¹/₈" 180-321-130

Smooth

130mm, 5¹/₈" 180-320-130



CRILE MURRAY

Serrated jaw, straight

150mm, 6" 180-330-150

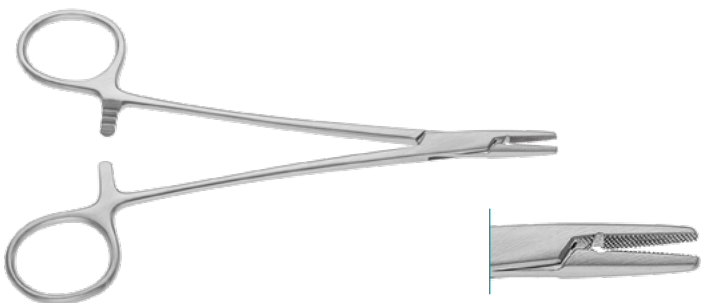

CRILE WOOD

Serrated jaw, straight

150mm, 6" 180-332-150

180mm, 7" 180-332-180

200mm, 8" 180-332-200

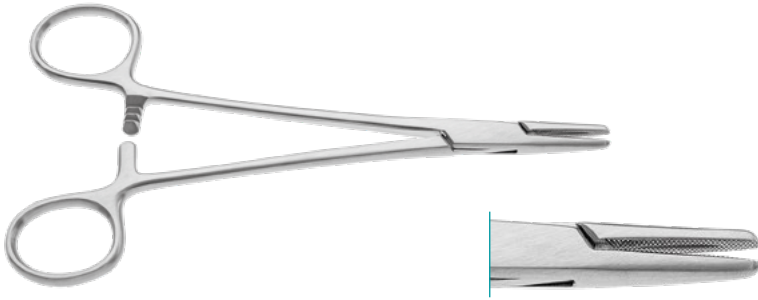
**MAYO HEGAR**

Grooved serrated jaw, straight

140mm, 5 ¹ / ₂ "	180-354-140
160mm, 6 ¹ / ₄ "	180-354-160
180mm, 7"	180-354-180
200mm, 8"	180-354-200
240mm, 9 ¹ / ₂ "	180-354-240
260mm, 10 ¹ / ₄ "	180-354-260
300mm, 11 ⁷ / ₈ "	180-354-300

**MAYO HEGAR FINO**

Delicate Pattern, serrated, straight

140mm, 5 ¹ / ₂ "	180-356-140
160mm, 6 ¹ / ₄ "	180-356-160
180mm, 7"	180-356-180
200mm, 8"	180-356-200

**OLSEN HEGAR**

Serrated jaw, straight

140mm, 5 ¹ / ₂ "	180-382-140
170mm, 6 ² / ₃ "	180-382-170
180mm, 7"	180-382-180

**MATHIEU**

Serrated jaw, straight

140mm, 5 ¹ / ₂ "	180-420-140
170mm, 6 ² / ₃ "	180-420-170
200mm, 8"	180-420-200

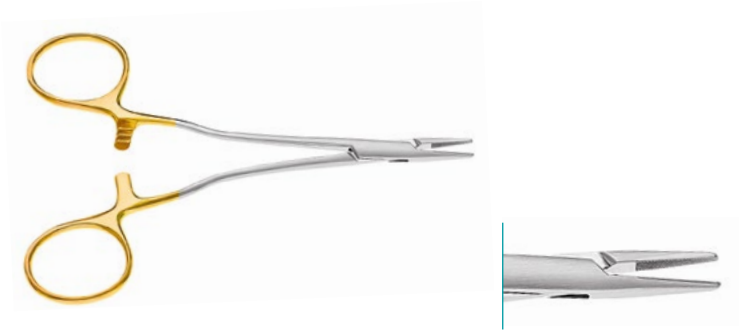

CONVERSE

Cross-serrated jaw, straight

120mm, 4³/₄" 180-544-120



DERF

Serrated jaw, straight

120mm, 4³/₄" 180-532-120



HEGAR BAUMGARTNER

Serrated jaw, straight

125mm, 5" 180-534-125

140mm, 5¹/₂" 180-534-140

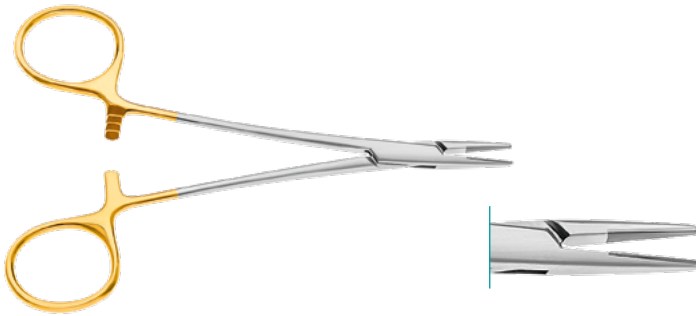

WEBSTER

Smooth jaw, delicate pattern, straight

130mm, 5¹/₈" 180-538-130

serrated jaw

130mm, 5¹/₈" 180-539-130



HALSEY

Serrated jaw, straight

130mm, 5¹/₈" 180-537-130

smooth jaw

130mm, 5¹/₈" 180-536-130



BABY CRILE WOOD

Serrated jaw, straight

150mm, 6" 180-542-150



CRILE WOOD

Serrated jaw, straight

150mm, 6"	180-540-150
180mm, 7"	180-540-180
200mm, 8"	180-540-200
230mm, 9"	180-540-230
260mm, 10 ¹ / ₄ "	180-540-260
300mm, 11 ⁷ / ₈ "	180-540-300

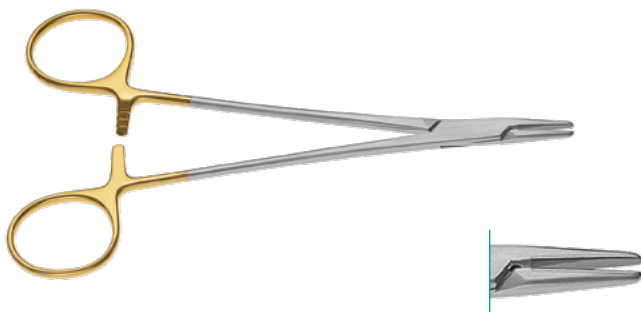

CRILE WOOD

Smooth jaw, straight

150mm, 6"	180-541-150
180mm, 7"	180-541-180
200mm, 8"	180-541-200
230mm, 9"	180-541-230

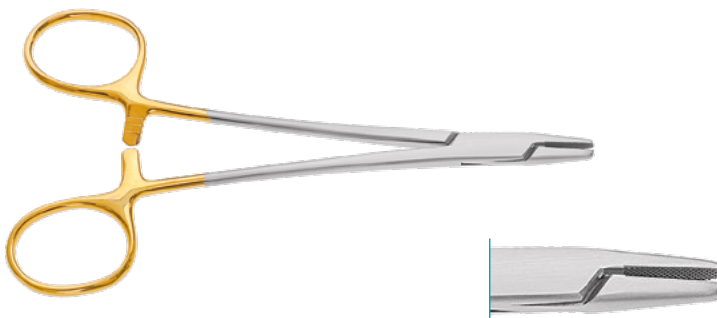

MAYO HEGAR

Serrated jaw, straight

125mm, 5"	180-550-125
140mm, 5 ¹ / ₂ "	180-550-140
160mm, 6 ¹ / ₄ "	180-550-160
180mm, 7"	180-550-180
200mm, 8"	180-550-200
240mm, 9 ¹ / ₂ "	180-550-240
260mm, 10 ¹ / ₄ "	180-550-260
300mm, 11 ⁷ / ₈ "	180-550-300
355mm, 14"	180-550-355
400mm, 15 ³ / ₄ "	180-550-400

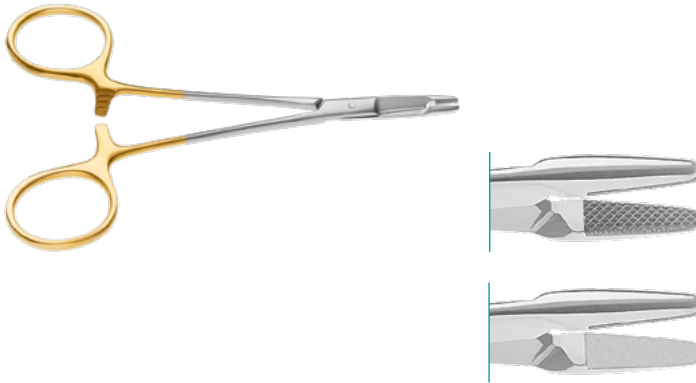

MINI OLSEN HEGAR

Serrated jaw, straight

120mm, 4^{3/4}" 180-568-120

smooth jaw

120mm, 4^{3/2}" 180-569-120



OLSEN HEGAR

Serrated jaw, straight

140mm, 5^{1/2}" 180-568-140

170mm, 6^{2/3}" 180-568-170

180mm, 7" 180-568-180

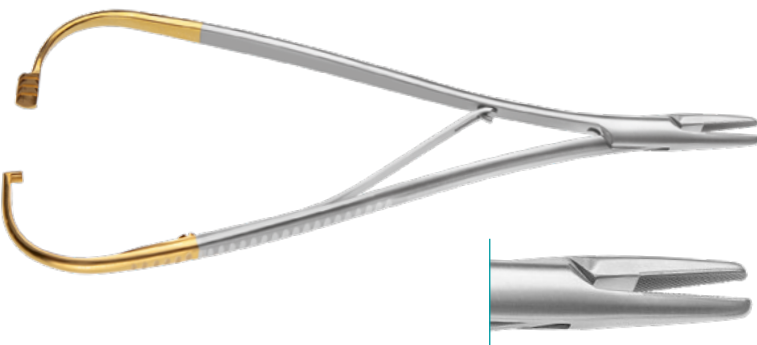

MATHIEU

Serrated jaw, straight

140mm, 5^{1/2}" 180-576-140

170mm, 6^{2/3}" 180-576-170

200mm, 8" 180-576-200

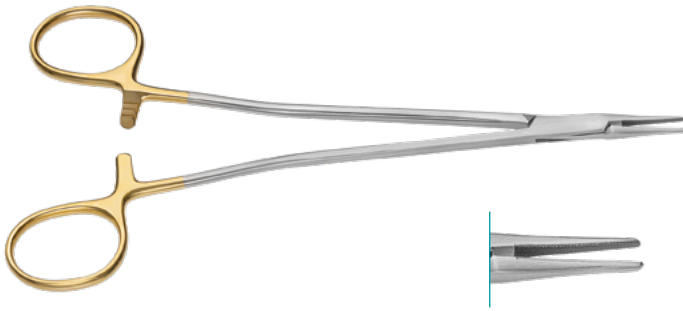

HEGAR

Vascular, micro profile, straight

140mm, 5 ¹ / ₂ "	180-590-140
180mm, 7"	180-590-180
200mm, 8"	180-590-200
230mm, 9"	180-590-230

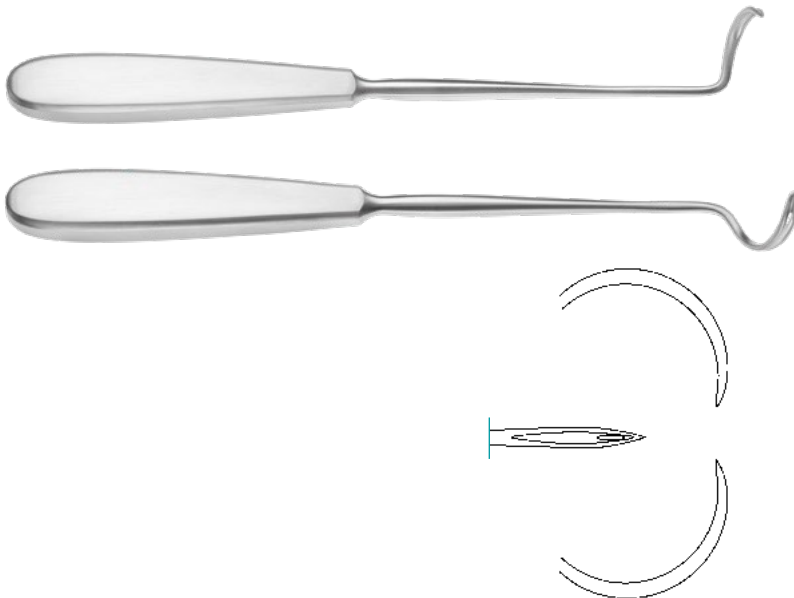

DESCHAMPS

Ligature Needles, sharp

left curved, for right hand	180-724-200
right curved, for left hand	180-728-200

blunt

left curved, for right hand	180-726-210
right curved, for left hand	180-727-210





retractors.





GRAEFFE

Micro Skin Hook, 125mm, 5"

sharp	170-010-125
blunt	170-011-125



KILNER

Skin Hook, sharp

150mm, 6"	230-203-150
-----------	-------------

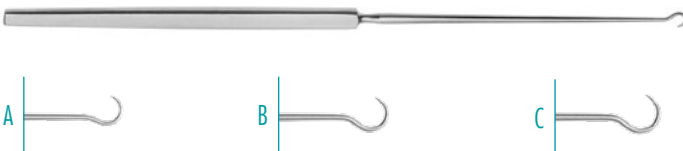

GILLIES

Skin Hook, 180mm, 7"

A Small	230-205-180
B Medium	230-207-180
C Large	230-209-180



JOSEPH

Skin Hook

160mm, 6 ^{1/4} "	170-014-001
---------------------------	-------------



Cat Castration Hook

170-015-171

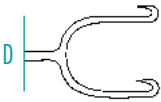
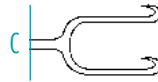
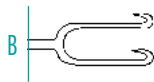
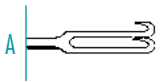

JOSEPH

Skin Hook, 2 prongs, 160mm, 6¹/₄"

A	2mm wide	170-014-002
B	5mm wide	170-014-005
C	7mm wide	170-014-007
D	10mm wide	170-014-010

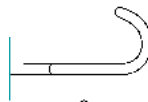

BABY SENN-MILLER

Hand Held Retractor,
8 x 7mm / 20 x 7mm, 155mm, 6¹/₈"

sharp	170-214-160
blunt	170-213-160

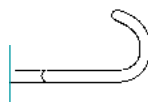

SENN MILLER

Hand Held Retractor,
8 x 7mm / 18 x 5.5mm, 160mm, 6¹/₄"

sharp	170-210-160
blunt	170-212-160

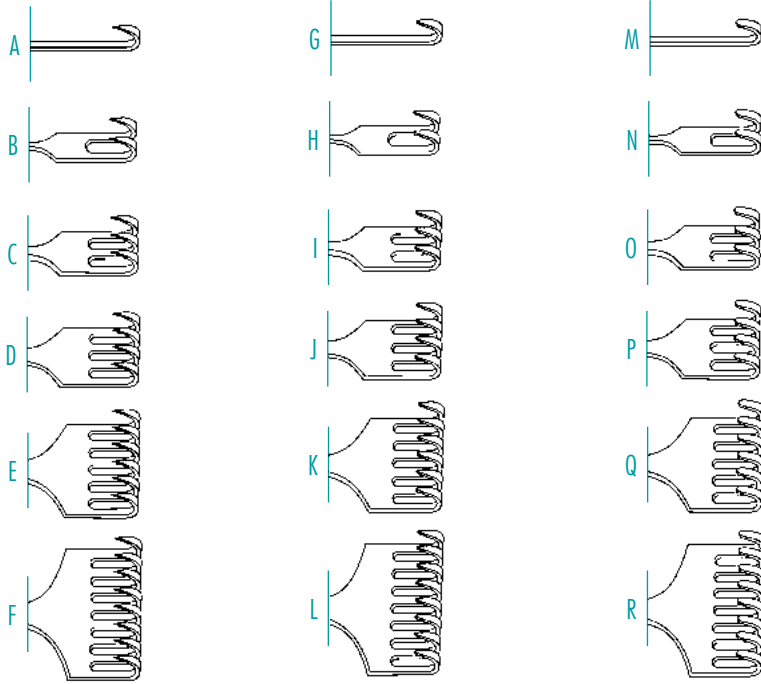

VOLKMANN

Retractor, 215mm, 8^{1/2}"
sharp

A	1 prong, 9mm	170-220-215
B	2 prongs, 9x8mm	170-222-215
C	3 prongs, 9x13mm	170-224-215
D	4 prongs, 9x19mm	170-226-215
E	6 prongs, 9x29mm	170-228-215
F	8 prongs, 9x40mm	170-230-215

semi - sharp

G	1 prong, 9mm	170-231-215
H	2 prongs, 9x8mm	170-233-215
I	3 prongs, 9x13mm	170-235-215
J	4 prongs, 9x19mm	170-237-215
K	6 prongs, 9x29mm	170-239-215
L	8 prongs, 9x40mm	170-241-215

blunt

M	1 prong, 9mm	170-221-215
N	2 prongs, 9x8mm	170-223-215
O	3 prongs, 9x13mm	170-225-215
P	4 prongs, 9x19mm	170-227-215
Q	6 prongs, 9x29mm	170-229-215
R	8 prongs, 9x40mm	170-231-215





KOCHER LANGENBECK

Retractor, 215mm, 8¹/₂"

22 x 6mm	170-317-022
25 x 8mm	170-317-025
25 x 6mm	170-317-026
35 x 8mm	170-317-035
35 x 11mm	170-317-036
35 x 15mm	170-317-037
40 x 11mm	170-317-040
55 x 11mm	170-317-055
70 x 15mm	170-317-070
80 x 12mm	170-317-080
80 x 15mm	170-317-081

RIBBON

Abdominal Retractor, malleable

200 x 6mm	170-973-006
200 x 12mm	170-973-012
200 x 17mm	170-973-017
200 x 20mm	170-973-020
250 x 25mm	170-973-025
330 x 10mm	170-963-010
330 x 13mm	170-963-013
330 x 19mm	170-963-019
330 x 25mm	170-963-025
330 x 32mm	170-963-032
330 x 40mm	170-963-040
330 x 50mm	170-963-050
330 x 68mm	170-963-068

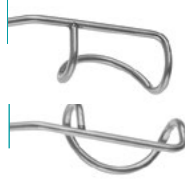

BARRAQUER

Eye Specula

Children, 10mm blade 400-500-030

Adult, 40mm blade 400-500-040

1mm wire thickness

Adult, 40mm blade 400-500-045



FINSEN

Spring Retractor, 2x3 teeth, 50mm, 2"

sharp 170-700-050

blunt 170-701-050

3x4 teeth, 70mm, 2³/₄"

sharp 170-702-070

blunt 170-703-070

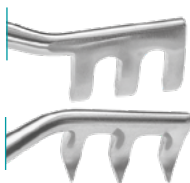

JANSEN

3x3 prongs, 100mm, 4"

sharp 170-720-100

blunt 170-723-100



BABY WEITLANER

2x3 teeth, 105mm, 4¹/₈"

sharp 170-748-105

115mm, 4¹/₂"

blunt 170-749-105

semi-sharp 170-750-105



WULLSTEIN

3x4 teeth, curved arms, 105mm, 4¹/₈"

sharp 170-742-105

blunt 170-743-105

130mm, 5¹/₈"

sharp 170-742-130

blunt 170-743-130

150mm, 6"

sharp 170-742-150

blunt 170-743-150

180mm, 7"

sharp 170-742-180

blunt 170-743-180



WEITLANER

3x4 teeth, sharp

130mm, 5¹/₈" 170-750-130

165mm, 6¹/₂" 170-750-165

200mm, 8" 170-750-200

240mm, 9¹/₂" 170-750-240

blunt

130mm, 5¹/₈" 170-751-130

165mm, 6¹/₂" 170-751-165

200mm, 8" 170-751-200

240mm, 9¹/₂" 170-751-240



ADSON

4x4 teeth, straight arms, 200mm, 8"

blunt	170-730-200
sharp	170-731-200



MEYERDING

Laminectomy Retractor, 200mm, 8"

25x32mm blade	170-791-001
25x54mm blade	170-791-002
19x60mm blade	170-791-003
25x60mm blade	170-791-004





GELPI Perineal Retractor, pediatric size	
90mm, 3 ¹ / ₂ "	170-802-090
110mm, 4 ¹ / ₃ "	170-802-110
135mm, 5 ¹ / ₃ "	170-802-135



GELPI Perineal Retractor	
180mm, 7"	170-802-180
with ball stops	
190mm, 7 ¹ / ₂ "	170-803-180

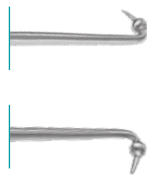

DEBAKEY sharp	
100mm, 4"	170-745-100
170mm, 6 ² / ₃ "	170-745-170

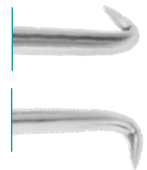

JOHNSON Neuroma Retractor, 90° angled, 7.5mm tip	
85mm, 3 ¹ / ₄ "	170-801-085
100mm, 4"	170-801-100

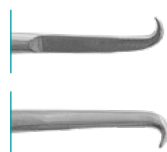



FINOCHIETTO BABY

Rib Spreader, straight arms

51 x 15 x 13mm (length/width/depth)

55mm spread 290-177-055

51 x 15 x 13mm (length/width/depth)

75mm spread 290-177-070

60 x 21 x 18mm (length/width/depth)

80mm spread 290-177-075

curved arms

60 x 21 x 18mm (length/width/depth)

80mm spread 290-179-075

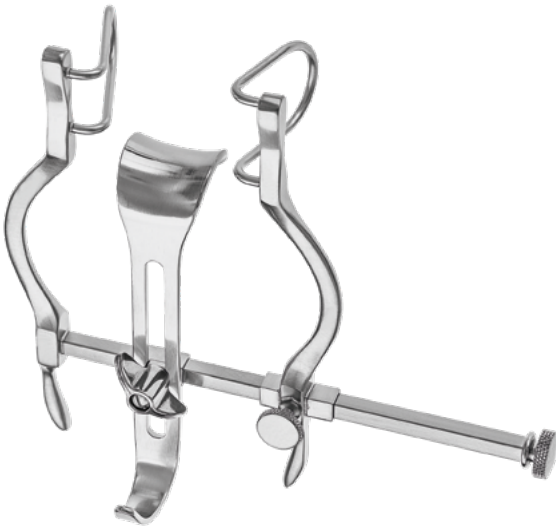

BALFOUR BABY

Abdominal Retractor

95mm wide, 2 lateral blades: 38mm

center blade: 23 x 25mm

170-766-090



BALFOUR

Abdominal Retractor, 180mm spread width,
lateral wire blades: 50mm

75 x 50mm 170-852-050

skin and wound.





FOR BLADES #3

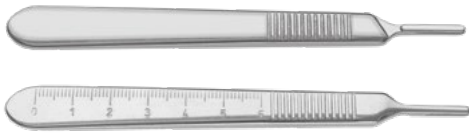

Knife Handle #3, 130mm, 5¹/₈"

	110-110-003
with cm/mm scale	110-114-003



Knife Handle #3L

210mm, 8 ¹ / ₄ "	110-116-033
360mm, 14"	110-116-133



Knife Handle #7

165mm, 6 ¹ / ₂ "	110-130-077
--	-------------

FOR BLADES #4



Knife Handle #4, 135mm, 5¹/₃"

	110-140-004
with cm/mm scale	110-141-004



Knife Handle #4L

210mm, 8 ¹ / ₄ "	110-144-004
--	-------------



Button-end Probe, \varnothing 1mm

115mm, 4 ¹ / ₂ "	160-102-115
130mm, 5 ¹ / ₈ "	160-102-130
145mm, 5 ³ / ₄ "	160-102-145
160mm, 6 ¹ / ₄ "	160-102-160
180mm, 7"	160-102-180
200mm, 8"	160-102-200

\varnothing 2mm

115mm, 4 ¹ / ₂ "	160-100-115
130mm, 5 ¹ / ₈ "	160-100-130
145mm, 5 ³ / ₄ "	160-100-145
160mm, 6 ¹ / ₄ "	160-100-160
180mm, 7"	160-100-180
200mm, 8"	160-100-200

Button-end Probe, with eye, \varnothing 2mm

115mm, 4 ¹ / ₂ "	160-108-115
130mm, 5 ¹ / ₈ "	160-108-130
145mm, 5 ³ / ₄ "	160-108-145
160mm, 6 ¹ / ₄ "	160-108-160
180mm, 7"	160-108-180
200mm, 8"	160-108-200



Probe, \varnothing 1.5mm

130mm, 5 ¹ / ₈ "	160-099-130
145mm, 5 ³ / ₄ "	160-099-145
160mm, 6 ¹ / ₄ "	160-099-160
200mm, 8"	160-099-200

**REDON**

Guide Needle, lancet tip, slightly curved,
with threaded end
185mm, 7^{1/4}"

8 Charr	165-204-080
10 Charr	165-204-100
12 Charr	165-204-120
14 Charr	165-204-140
16 Charr	165-204-160



Grooved Director

115mm, 4 ^{1/2} "	160-107-115
130mm, 5 ^{1/8} "	160-107-130
145mm, 5 ^{3/4} "	160-107-145
160mm, 6 ^{1/4} "	160-107-160
180mm, 7"	160-107-180
200mm, 8"	160-107-200



Grooved Director, buttoned

130mm, 5 ^{1/8} "	160-170-130
145mm, 5 ^{3/4} "	160-170-145
160mm, 6 ^{1/4} "	160-170-160
180mm, 7"	160-170-180

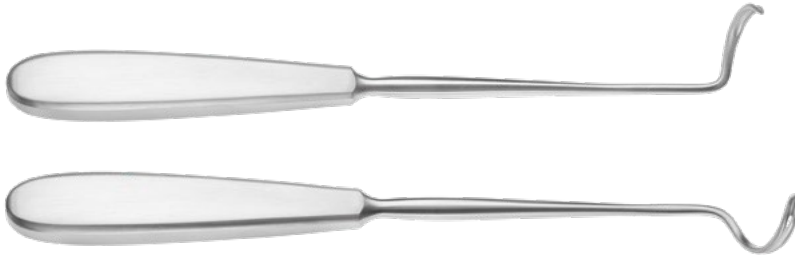

DESCHAMPS

Ligature Needles, sharp

left curved, for right hand 180-724-200

right curved, for left hand 180-728-200

blunt

left curved, for right hand 180-726-210

right curved, for left hand 180-727-210

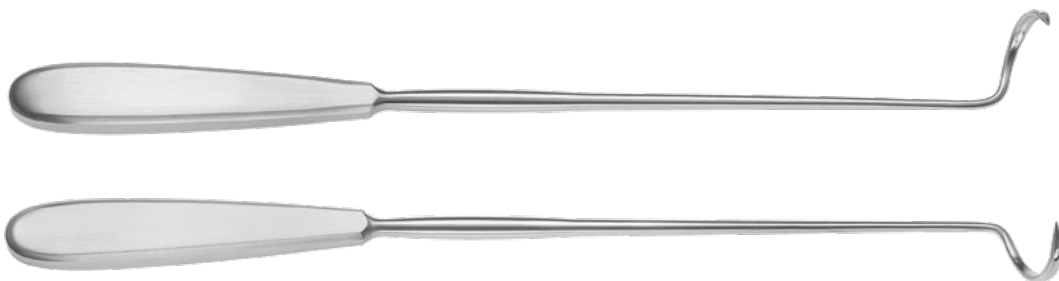
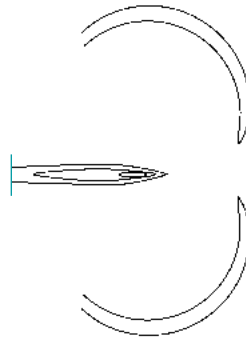

DESCHAMPS

Needle, left curved, sharp, for right hand

270mm, 10²/₃" 180-732-270

right curved, for left hand

270mm, 10²/₃" 180-733-270

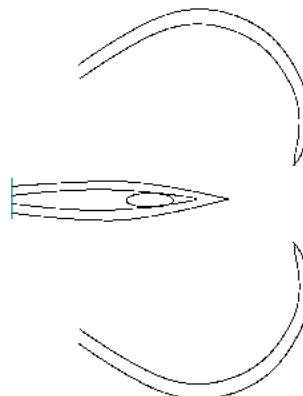



orthopaedics.





LISTER

Plaster Cast / Bandage Scissors

90mm, 3 ¹ / ₂ "	190-165-090
110mm, 4 ¹ / ₃ "	190-165-110
140mm, 5 ¹ / ₂ "	190-165-140
180mm, 7"	190-165-180
200mm, 8"	190-165-200
210mm, 8 ¹ / ₄ "	190-170-210



TC LISTER

Bandage Scissors

180mm, 7"	190-291-180
-----------	-------------



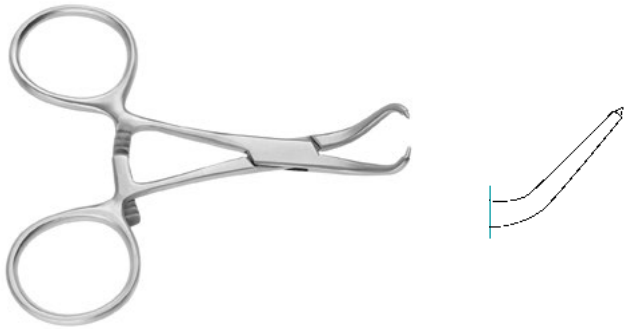

Bone Reposition Forceps

95mm, 3³/₄" 210-651-095

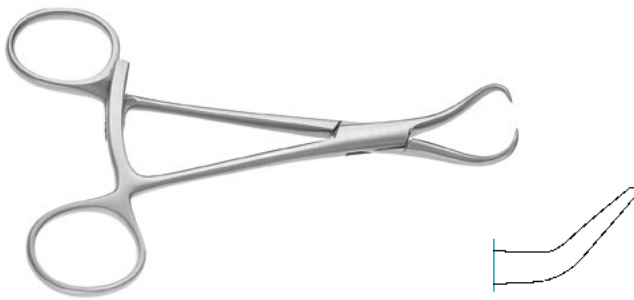

STEINHAUSER
Bone Reposition Forceps,
extra long ratchet

135mm, 5¹/₃" 210-651-135

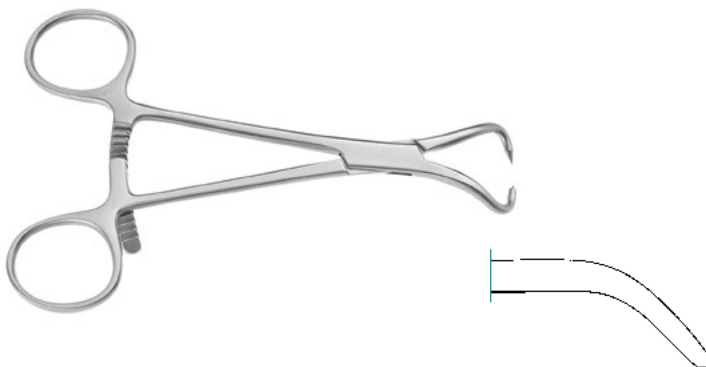

**Bone Reduction Forceps,
curved, stepped point**

135mm, 5¹/₃" 210-665-135

170mm, 6²/₃" 210-665-170

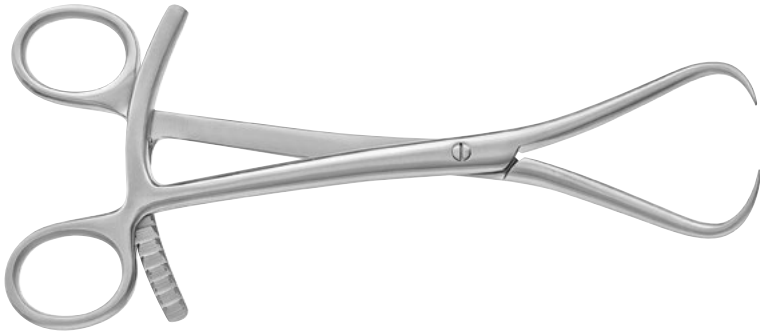

Reposition Forceps

200mm, 8"

210-651-200



Bone Fragment Clamp

120mm, 4^{3/4}"

210-631-120



MEYER

**Reposition Forceps for Finger,
with drill guide**

170mm, 6^{2/3}"

210-650-170

200mm, 8"

210-650-200



Reposition Forceps

140mm, 5^{1/2}"

210-718-140



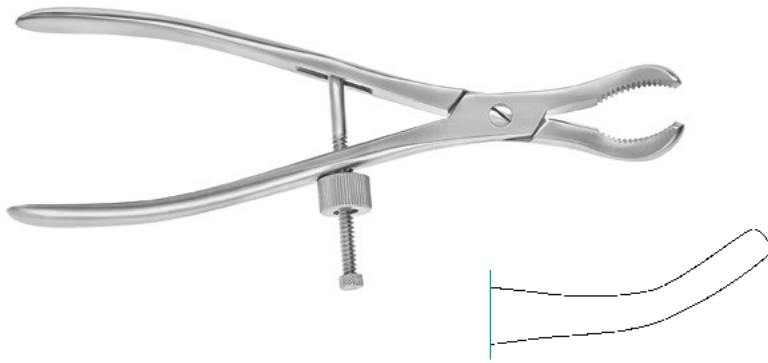

SETTER

Bone Holding Forceps, curved, speed lock

160mm, 6 ¹ / ₄ "	210-719-160
225mm, 8 ⁷ / ₈ "	210-719-220

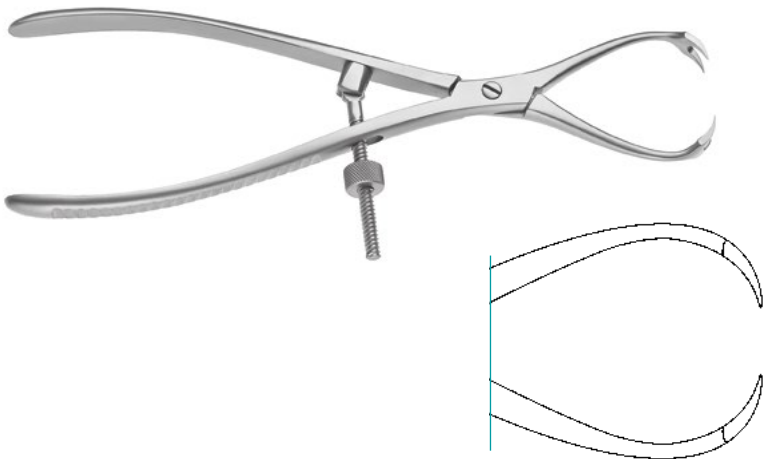

Patella Holding Forceps, 2x2 sharp teeth

185mm, 7 ¹ / ₄ "	210-654-185
--	-------------



KERN

Bone Holding Forceps, with ratchet

170mm, 6 ² / ₃ "	210-621-170
240mm, 9 ¹ / ₂ "	210-621-210

without ratchet

170mm, 6 ² / ₃ "	210-620-170
240mm, 9 ¹ / ₂ "	210-620-210



VERBRUGGE
Bone Holding Forceps

175mm, 6 ⁷ / ₈ "	210-605-170
250mm, 9 ⁷ / ₈ "	210-605-250
260mm, 10 ¹ / ₄ "	210-605-260
270mm, 10 ² / ₃ "	210-605-270



Bone Holding Forceps, self-centering

150mm, 6"	210-603-150
190mm, 7 ¹ / ₂ "	210-603-190
240mm, 9 ¹ / ₂ "	210-603-240
260mm, 10 ¹ / ₄ "	210-603-260
280mm, 11"	210-603-280



LAMBOTTE
Bone Holding Forceps, movable jaw

220mm, 8 ² / ₃ " 10mm jaw width	210-640-220
270mm, 10 ² / ₃ " 13mm jaw width	210-640-270
300mm, 11 ⁷ / ₈ " 16mm jaw width	210-640-300



FRIEDMANN

Bone Rongeur, 90°, curved

140mm, 5¹/₂"

210-642-120

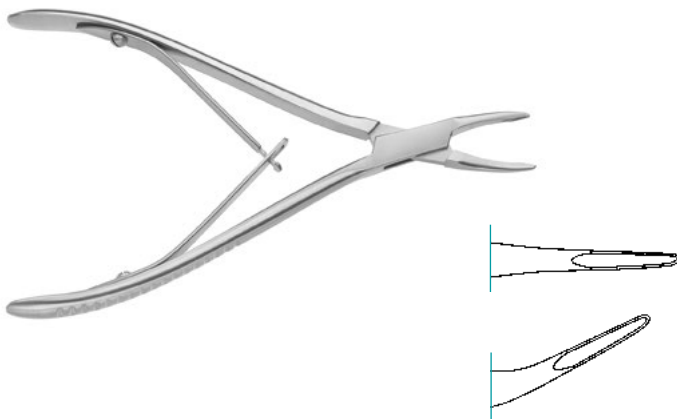

MINI FRIEDMANN

Bone Rongeur, 1.1mm delicate jaw

140mm, 5¹/₂"

Straight

210-640-150

Curved

210-641-150



FRIEDMANN

Bone Rongeur, 140mm, 5¹/₂"

Curved

210-640-140

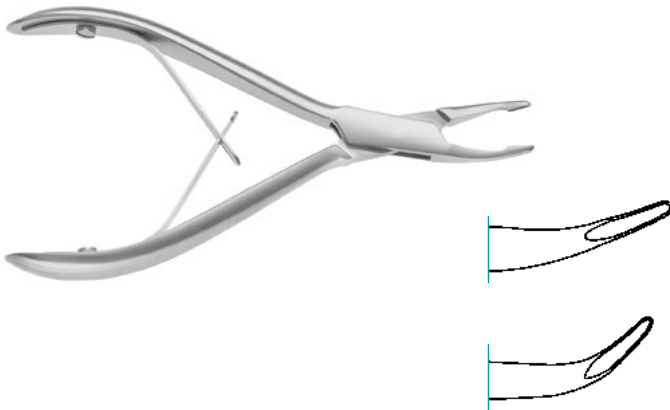

KLEINERT KUTZ

Bone Rongeur, 2mm jaw,
140mm, 5¹/₂"

Slightly curved	210-642-140
Strongly curved	210-643-140

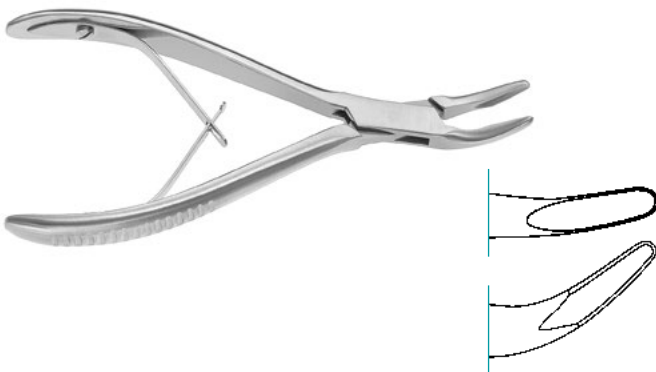

LUER

Bone Rongeur, 140mm, 5¹/₂"

Slightly curved	210-685-150
Strongly curved	210-687-150

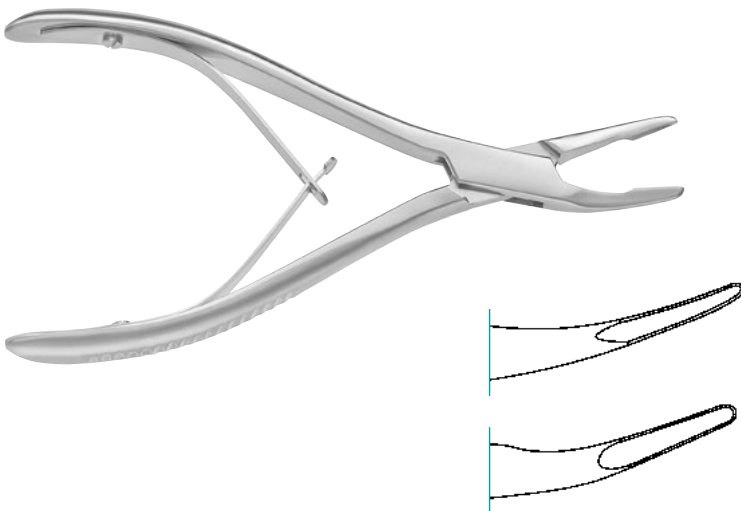

BEYER

Bone Rongeur, 3x16mm, 180mm, 7"

Curved	210-830-180
Strongly Curved	210-831-180

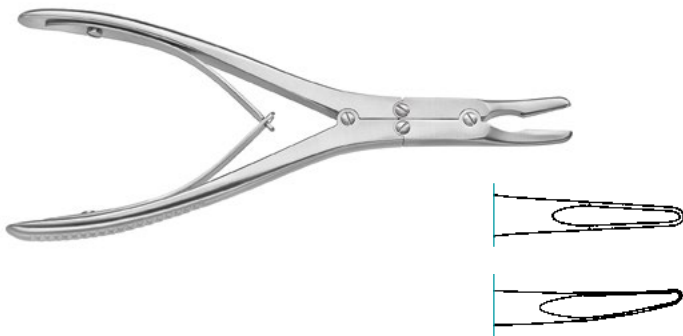

MINI RUSKIN

Bone Rongeur, 2mm, 150mm, 6"

Straight	210-802-150
Curved	210-812-150

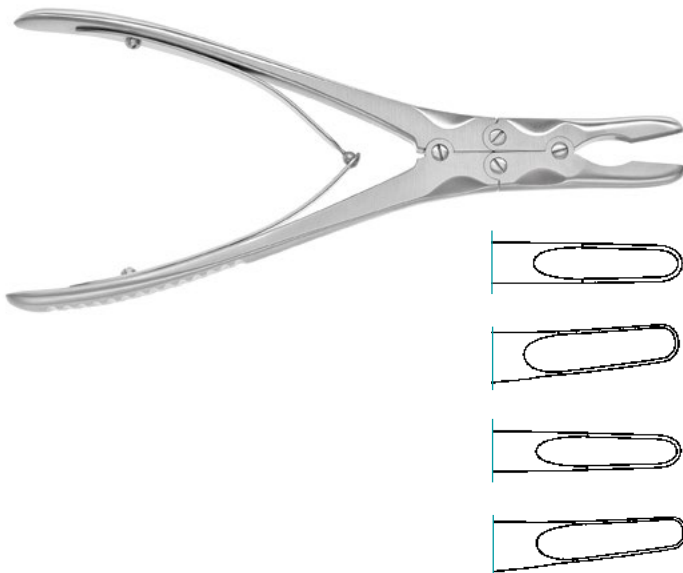

RUSKIN

Bone Rongeur, 5mm, 180mm, 7"

Straight	210-800-180
Curved	210-801-180

4mm

Straight	210-802-180
Curved	210-803-180

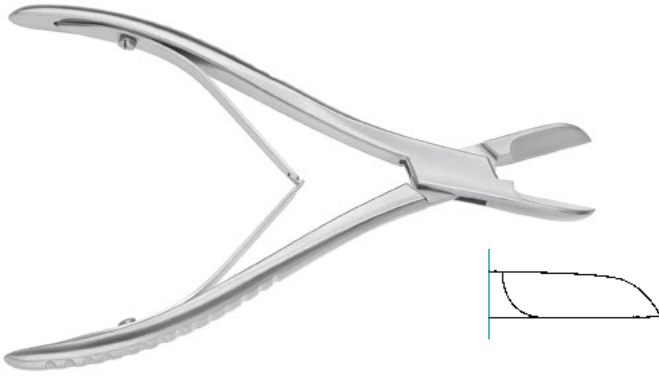

LITTAUER
Bone Cutting Forceps with spring

150mm, 6" 210-397-150

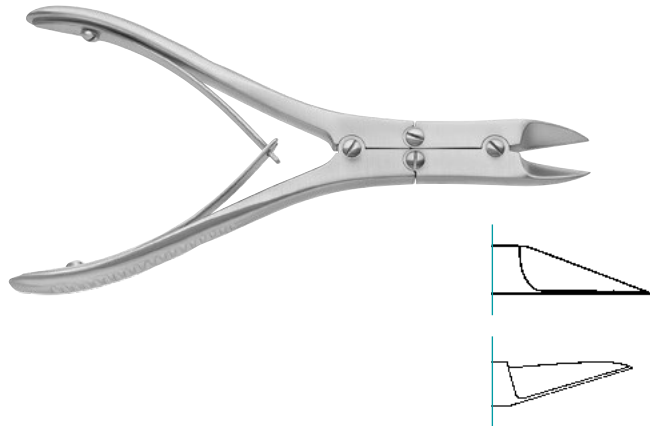

BOEHLER
Bone Cutting Forceps, double action,
straight

150mm, 6" 210-892-150

curved on flat

150mm, 6" 210-890-150

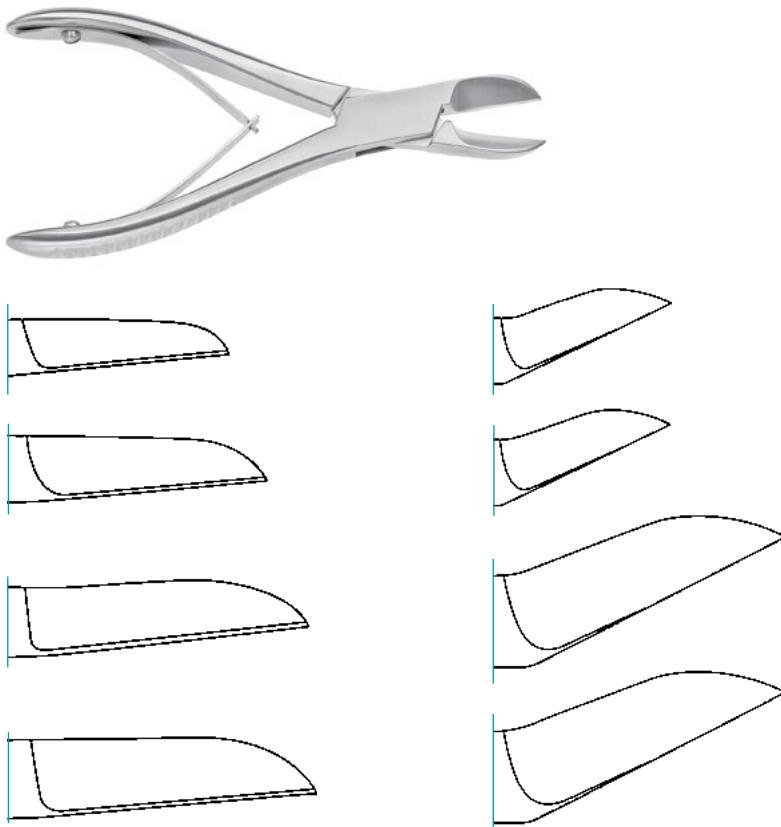

LISTON
Bone Cutting Forceps, straight

140mm, 5¹/₂" 210-934-140

170mm, 6²/₃" 210-934-170

190mm, 7¹/₂" 210-934-190

220mm, 8²/₃" 210-934-220

angled

140mm, 5¹/₂" 210-935-140

170mm, 6²/₃" 210-935-170

190mm, 7¹/₂" 210-935-190

220mm, 8²/₃" 210-935-220



Bone Hook, 1 tooth, sharp

245mm, 9²/₃"

170-292-245

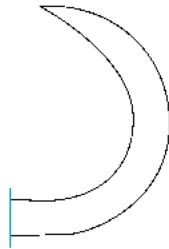

Bone Lever, 2.8mm

140mm, 5¹/₂"

210-539-110

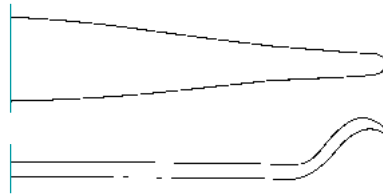

HOHMANN

Bone Lever, 2mm tip, 8mm wide

160mm, 6¹/₄"

210-541-080

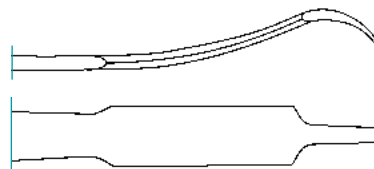

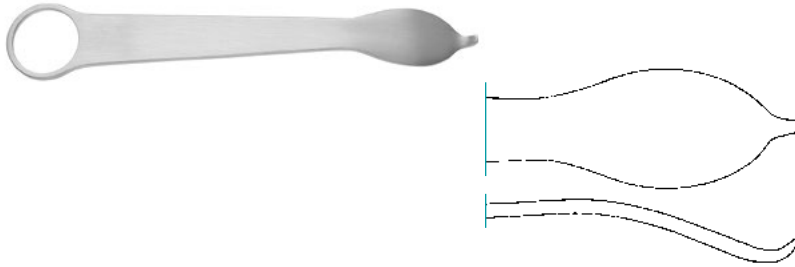

HOHMANN

Bone Lever, 15mm wide tip, with finger ring

120mm, 4^{3/4}"

210-541-150

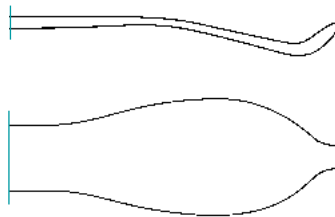

Mini Bone Lever, 15mm wide tip

160mm, 6^{1/4}"

210-539-150

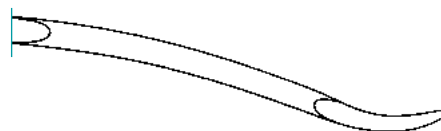

HOHMANN

Bone Lever, 240mm, 9^{1/2}"

8mm 210-541-108

10mm 210-541-100

18mm 210-541-180

24mm 210-541-240

43mm 210-541-430

70mm 210-541-700



HOHMANN
Bone Lever, 17mm, sharp

240mm, 9¹/₂" 210-542-180

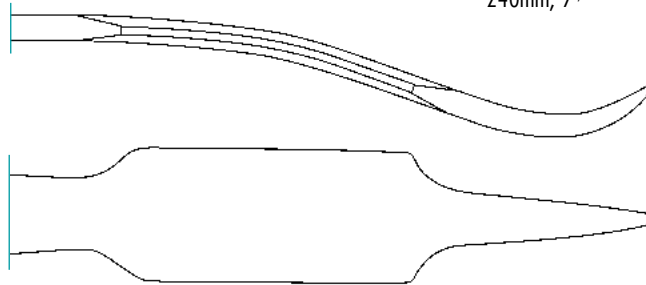

HOHMANN
Bone Lever, 24mm

260mm, 10¹/₄" 210-545-220

35mm
285mm, 11¹/₄" 210-545-350

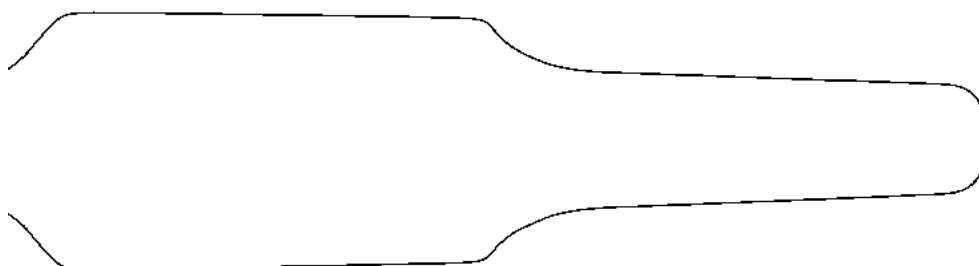
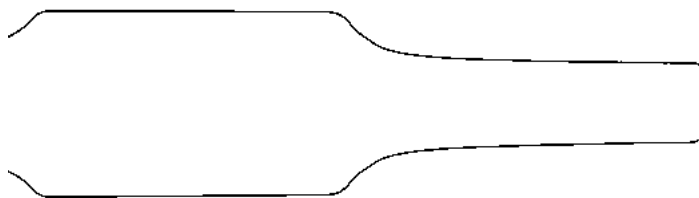
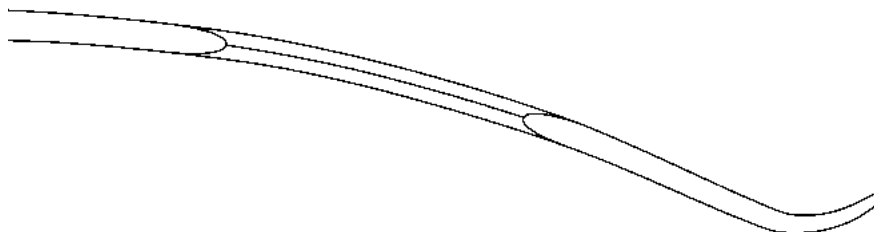



VERBRUGGE

Bone Lever, 25mm

200mm, 8" 210-542-025

45mm

230mm, 9" 210-542-045

70mm

250mm, 9⁷/₈" 210-542-070

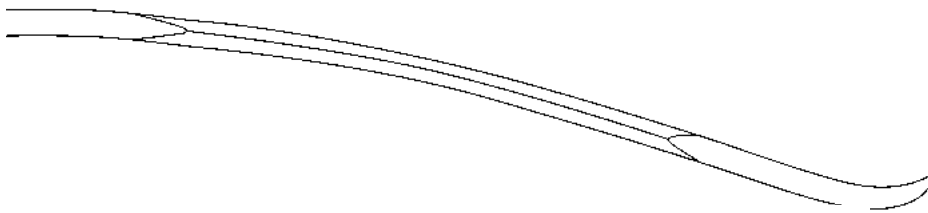

HOHMANN

Bone Lever, 43mm

235mm, 9¹/₄" 210-543-430





WILLIGER
Elevator, 160mm, 6^{1/4}"

5.5mm	210-395-160
7.0mm	210-396-170

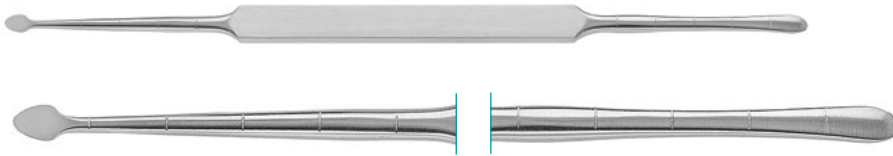

COTTLE
Elevator, double-ended, graduated,
sharp/sharp

200mm, 8"	420-550-230
-----------	-------------

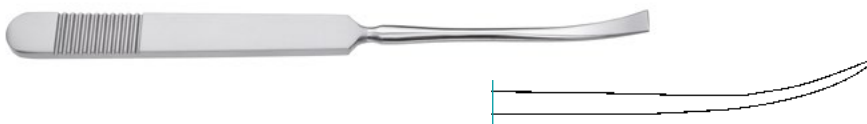

PENNYBAKER
Elevator, sharp, 6mm

150mm, 6"	210-488-170
-----------	-------------



COBB
Elevator, 240mm, 9^{1/2}"

9mm	210-401-095
13mm	210-401-127
19mm	210-401-019
25mm	210-401-025
32mm	210-401-032

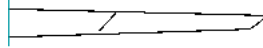

Raspatory, synthetic handle,
6mm

190mm, 7¹/₂" 210-434-180

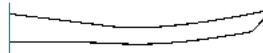

3mm

185mm, 7¹/₄" 210-432-185



6mm

185mm, 7¹/₄" 210-433-180



6mm

185mm, 7¹/₄" 210-432-180





WILLIGER

Double Curette, oval/oval, 140mm, 5¹/₂"

A #00/0 (Ø 2.5 / 3.0mm)	210-216-000
B #0/1 (Ø 3.0 / 3.5mm)	210-216-001
C #1/2 (Ø 3.5 / 4.2mm)	210-216-002

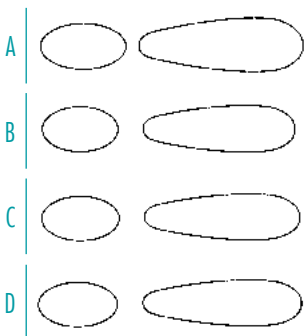

VOLKMANN

Double Curette, 130mm, 5¹/₈"

A 6.5 / 7.7mm	210-210-130
140mm, 5¹/₂"	
B 6.2 / 6.8mm	210-210-140
170mm, 6²/₃"	
C 6.8 / 6.8mm	210-210-170
200mm, 8"	
D 6.2 / 7.5mm	210-210-200

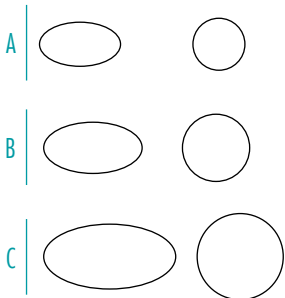

VOLKMANN

Double Curette, 130mm, 5¹/₈"

A 6.8 / 6.3mm	210-211-130
160mm, 6¹/₄"	
B 9.0 / 7.0mm	210-211-160
200mm, 8"	
C 11.0 / 9.0mm	210-211-200

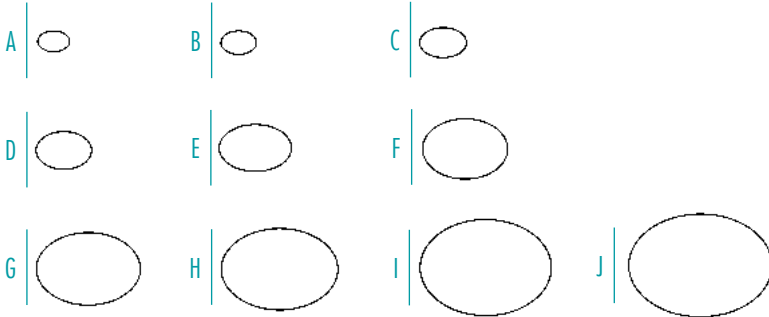
**VOLKMANN**Bone Curette, 170mm, 6^{2/3}"

A #0000	210-304-400
B #000	210-304-300
C #00	210-304-200
D #0	210-304-100
E #1	210-304-010
F #2	210-304-020
G #3	210-304-030
H #4	210-304-040
I #5	210-304-050
J #6	210-304-060

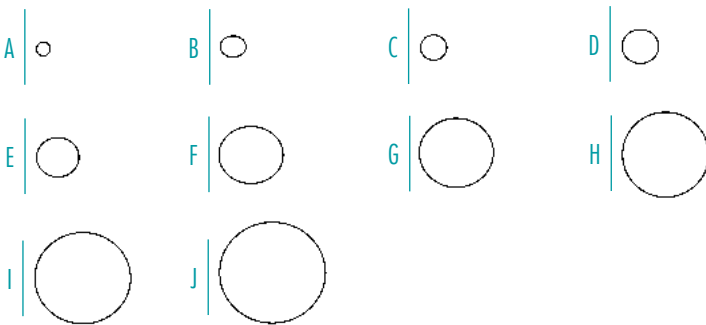
**BRUNS**Bone Curette, round, 170mm, 6^{2/3}"

A #0000	210-306-400
B #000	210-306-300
C #00	210-306-200
D #0	210-306-100
E #1	210-306-010
F #2	210-306-020
G #3	210-306-030
H #4	210-306-040
I #5	210-306-050
J #6	210-306-060

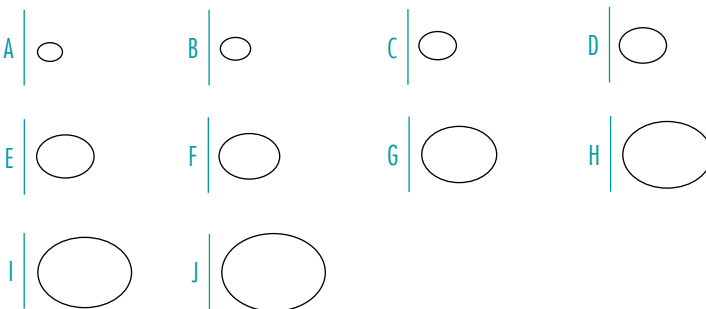
**BRUNS**Bone Curette, synthetic handle,
170mm, 6^{2/3}"

A #0000, 2.5mm	210-302-100
B #000, 3.0mm	210-302-101
C #00, 3.7mm	210-302-102
D #0, 4.7mm	210-302-103
E #1, 5.7mm	210-302-104
F #2, 6.0mm	210-302-105
G #3, 7.4mm	210-302-106
H #4, 8.8mm	210-302-107
I #5, 9.2mm	210-302-108
J #6, 10.3mm	210-302-109

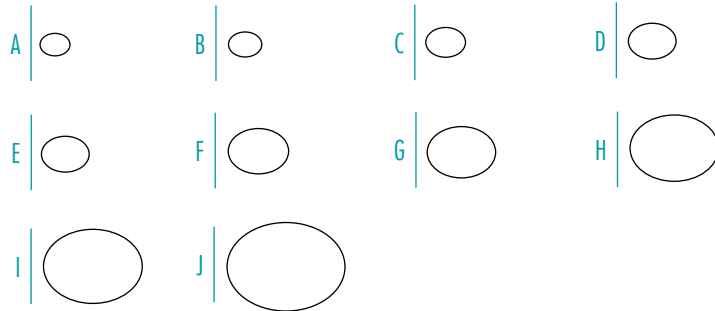

VOLKMANN BRUNS
Bone Curette, 230mm, 9"
straight jaw

A #0000	210-314-400
B #000	210-314-300
C #00	210-314-200
D #0	210-314-100
E #1	210-314-001
F #2	210-314-002
G #3	210-314-003
H #4	210-314-004
I #5	210-314-005
J #6	210-314-006

angled

A #0000	210-315-400
B #000	210-315-300
C #00	210-315-200
D #0	210-315-100
E #1	210-315-001
F #2	210-315-002
G #3	210-315-003
H #4	210-315-004
I #5	210-315-005
J #6	210-315-006



**PARTSCH****Osteotome, 140mm, 5^{1/2}"**

4mm	210-100-004
6mm	210-100-006
8mm	210-100-008
10mm	210-100-010
12mm	210-100-012

**PARTSCH****Chisel, 135mm, 5^{1/3}"**

2mm	210-302-135
3mm	210-303-135
5mm	210-305-135
6mm	210-306-135
7mm	210-307-135
8mm	210-308-135

170mm, 6^{2/3}"

2mm	210-302-170
3mm	210-303-170
5mm	210-305-170
6mm	210-306-170
7mm	210-307-170
8mm	210-308-170

**PARTSCH****Gouge, 140mm, 5^{1/2}"**

2mm	210-109-002
3mm	210-109-003
4mm	210-109-004
5mm	210-109-005
6mm	210-109-006
7mm	210-109-007
8mm	210-109-008

170mm, 6^{2/3}"

2mm	210-110-002
3mm	210-110-003
4mm	210-110-004
5mm	210-110-005
6mm	210-110-006
7mm	210-110-007
8mm	210-110-008



COTTLE

Osteotome with depth marking, 180mm, 7"

4mm	210-487-004
7mm	210-487-007
8mm	210-487-008
10mm	210-487-010
12mm	210-487-012



MINI LAMBOTTE

Osteotome, 125mm, 5"

2mm	210-136-002
3mm	210-136-003
4mm	210-136-004
5mm	210-136-005
6mm	210-136-006
7mm	210-136-007
8mm	210-136-008
9mm	210-136-009
10mm	210-136-010
12mm	210-136-012
14mm	210-136-014
15mm	210-136-015



MINI LAMBOTTE

Osteotome, curved, 125mm, 5"

2mm	210-137-002
4mm	210-137-005
6mm	210-137-007
8mm	210-137-009
10mm	210-137-011
12mm	210-137-013

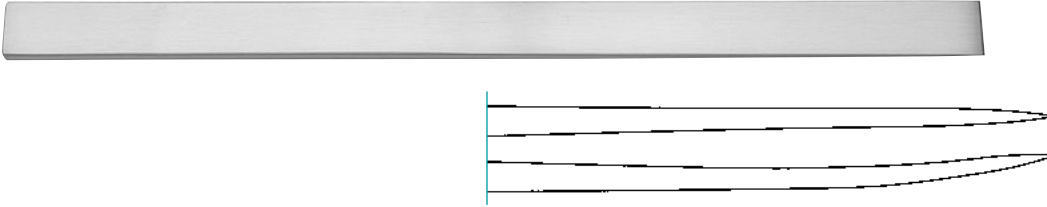

LAMBOTTE
Osteotome, 240mm, 9¹/₂"
straight

4mm	210-132-004
6mm	210-132-006
8mm	210-132-008
10mm	210-132-010
12mm	210-132-012
15mm	210-132-015
20mm	210-132-020
25mm	210-132-025

curved

4mm	210-133-004
6mm	210-133-006
8mm	210-133-008
10mm	210-133-010
12mm	210-133-012
15mm	210-133-015
20mm	210-133-020
25mm	210-133-025



WALTER
Osteotome, black, 190mm, 7¹/₂"

2mm	420-580-002
3mm	420-580-003
4mm	420-580-004
5mm	420-580-005



LUCAE
Mallet, Ø 25mm
140g

190mm, 7^{1/2}" 210-231-190



PARTSCH
Mallet, Ø 22mm
120g

180mm, 7" 210-225-180



Mallet, 2 interchangeable plastic discs,
Ø 25mm
140g

185mm, 7^{1/4}" 210-264-140

Spare Discs, pair 210-265-000



HAJEK
Mallet, Ø 27mm
140g

220mm, 8^{2/3}" 210-244-220

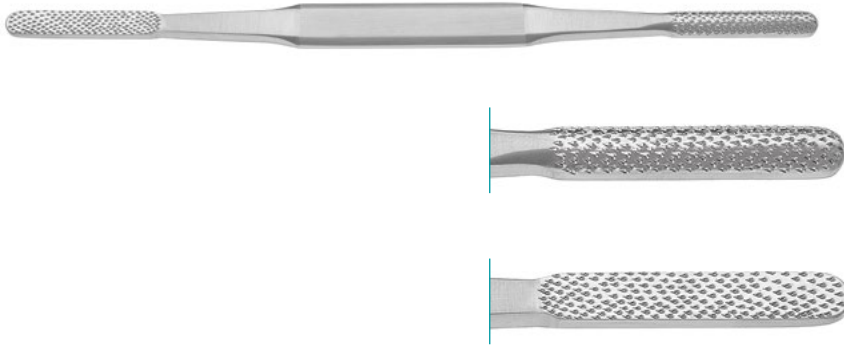

FOMON

Rasp, fine, double-ended, 7.5mm / 6.5mm

215mm, 8^{1/2}"

420-661-000



FOMON

Rasp, coarse, double-ended,
7.0mm / 8.0mm

215mm, 8^{1/2}"

420-660-000



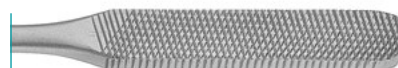
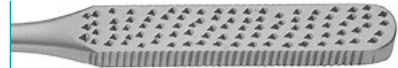

KLEINERT KUTZ
Rasp, double-ended, 4 sides
220mm, 8^{2/3}" 420-656-000

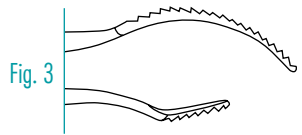
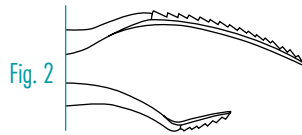

MILLER
Rasp, 90° cross-serrated, backwards cutting,
180mm, 7"
Fig. 1 8mm / 5mm 500-387-000
Fig. 2 6mm / 4mm 500-384-010
Fig. 3 6mm / 5mm 500-386-045



TC Wire Twisting Forceps

150mm, 6"

180-501-150



TC Wire Holding Clamp, round jaw

130mm, 5¹/₈"

180-569-130



Wire Holding Forceps

140mm, 5¹/₂"

200-515-140



Flat Nose Plier, distal jaw, smooth

140mm, 5¹/₂" 180-507-140



Flat Nose Plier, serrated jaw

140mm, 5¹/₂" 180-511-140



Flat Nose Plier, with groove

160mm, 6¹/₄" 200-518-160



Wire and Pin Bender / up to 3.2mm

150mm, 6"

200-204-150



LOUTE
Wire Tightener

210mm, 8¹/₄"

200-513-210

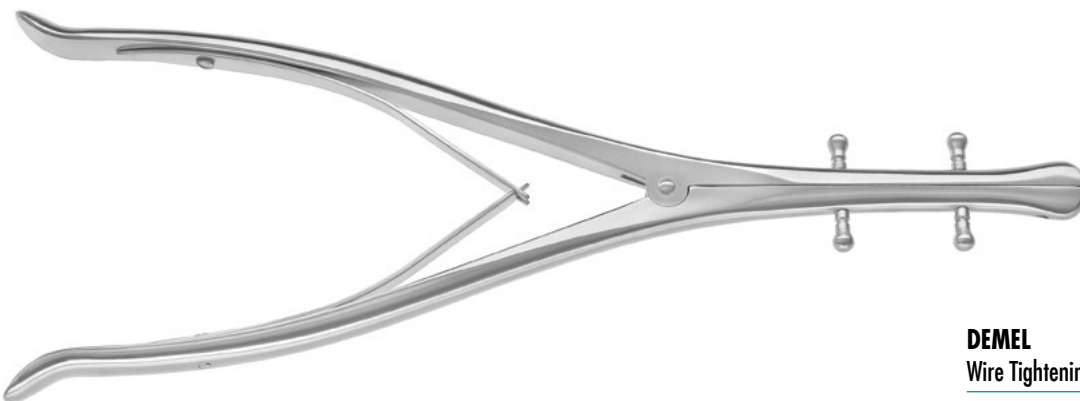

DEMEL
Wire Tightening- and Twisting Forceps

270mm, 10²/₃"

200-755-270

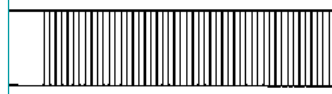

Wire Gripper, parallel closure

185mm, 7¹/₄"

200-513-185



Combined Wire Cutter and Gripper

180mm, 7"

180-512-185



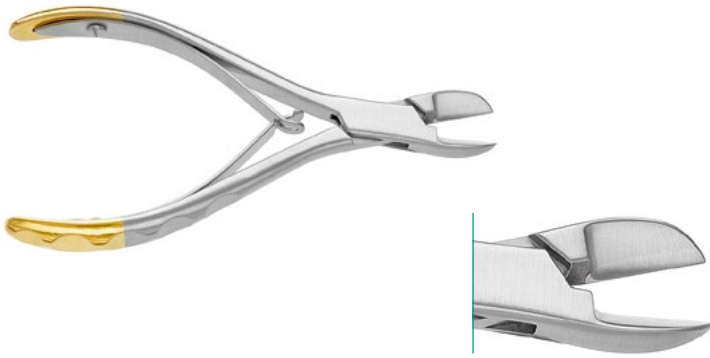

HARD max. 0.6mm
SOFT max. 1.0mm

TC Wire Cutter

120mm, 4^{3/4}"

200-500-120

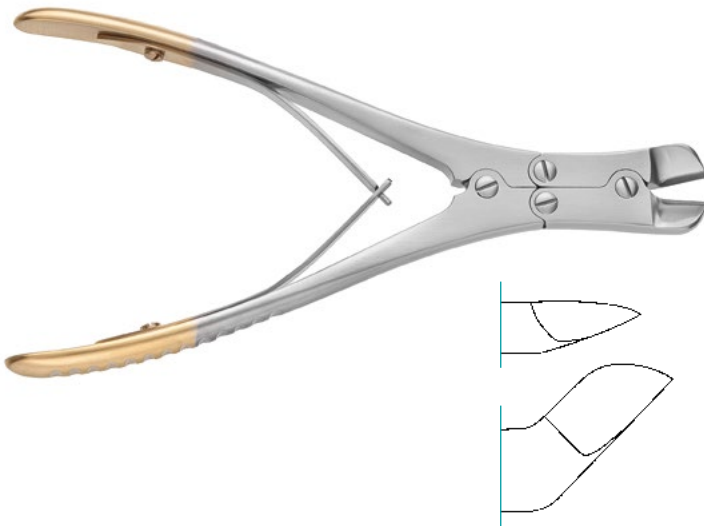

HARD max. 1.6mm
SOFT max. 2.0mm

TC Wire Cutter, angled

170mm, 6^{2/3}"

200-500-160



HARD max. 1.8mm
SOFT max. 2.2mm

REILL

TC Wire Cutter, angled

220mm, 8^{2/3}"

200-500-220





HARD max. 2.2mm
SOFT max. 3.0mm

TC Wire Cutter, 12° angled jaw

235mm, 9^{1/4}"



200-503-235



CUT  
 HARD max. 2.5mm
 SOFT max. 3.5mm

TC Front Wire Cutter
 220mm, 8²/₃" 200-506-220



CUT  
 HARD max. 1.6mm
 SOFT max. 2.0mm

TC Flush Wire Cutter
 180mm, 7" 200-508-180



CUT  
 UP TO 3.2mm

TC Wire Cutter, double action
 240mm, 9¹/₂" 200-522-240



CUT  
UP TO 6.0mm

TC Front Cutter

380mm, 15"

200-500-380

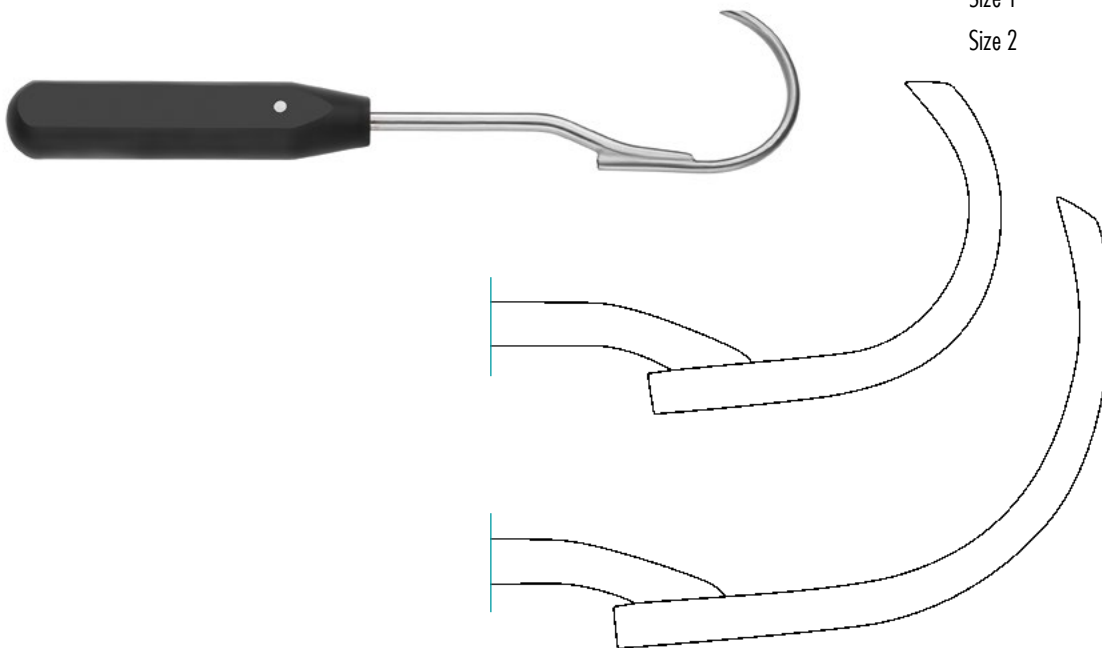

Wire Guide, synthetic handle, 210mm, 8¹/₄"

Size 1

180-751-018

Size 2

180-751-020



T-Handle, incl. key

Jacob Chuck 200-157-001



**T-Handle Drill, 1.0 - 6.0mm, cannulated,
Ø 5.2mm**

Universal Chuck 200-157-100



Depth Gauge

110mm, 4 ¹ / ₃ "	30mm screw	200-200-014
160mm, 6 ¹ / ₄ "	50mm screw	200-200-016
200mm, 8"	70mm screw	200-200-018
200mm, 8"	80mm screw	200-200-080
280mm, 11"	120mm screw	200-200-120



A
Screw Driver, synthetic handle,
hexagonal,
SW 1,5

120mm, 4 ^{3/4} "	200-603-120
250mm, 9 ^{7/8} "	200-608-200

Screw Holding Sheath for 200-605-200

200-603-205



B
Screw Driver, synthetic handle,
hexagonal,
SW 2,5

200mm, 8"	200-604-220
250mm, 9 ^{7/8} "	200-604-200

Screw Holding Sheath for 200-604-200

200-604-204



C
Screw Driver, synthetic handle,
hexagonal,
SW 3,5

250mm, 9 ^{7/8} "	200-605-200
---------------------------	-------------

Screw Holding Sheath for 200-605-200

200-603-205



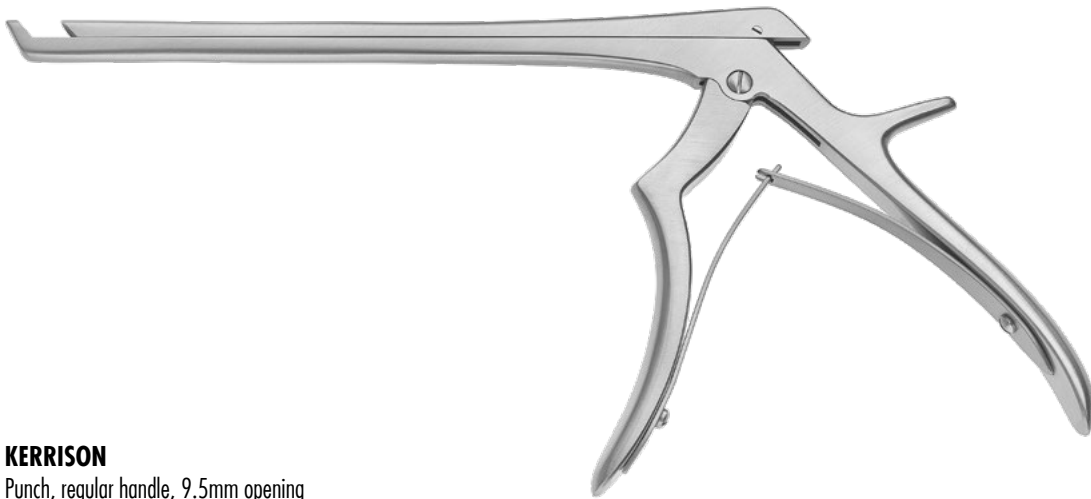

KERRISON

Punch, regular handle, 9.5mm opening



40° upwards cutting
180mm, 7"

1mm	250-400-181
2mm	250-400-182
3mm	250-400-183
4mm	250-400-184
5mm	250-400-185
6mm	250-400-186

200mm, 8"

1mm	250-400-201
2mm	250-400-202
3mm	250-400-203
4mm	250-400-204
5mm	250-400-205
6mm	250-400-206

230mm, 9"

1mm	250-400-231
2mm	250-400-232
3mm	250-400-233
4mm	250-400-234
5mm	250-400-235
6mm	250-400-236



90° upwards cutting
180mm, 7"

1mm	250-410-181
2mm	250-410-182
3mm	250-410-183
4mm	250-410-184
5mm	250-410-185
6mm	250-410-186

200mm, 8"

1mm	250-410-201
2mm	250-410-202
3mm	250-410-203
4mm	250-410-204
5mm	250-410-205
6mm	250-410-206

230mm, 9"

1mm	250-410-231
2mm	250-410-232
3mm	250-410-233
4mm	250-410-234
5mm	250-410-235
6mm	250-410-236



40° downwards cutting
180mm, 7"

1mm	250-420-181
2mm	250-420-182
3mm	250-420-183
4mm	250-420-184
5mm	250-420-185
6mm	250-420-186

200mm, 8"

1mm	250-420-201
2mm	250-420-202
3mm	250-420-203
4mm	250-420-204
5mm	250-420-205
6mm	250-420-206

230mm, 9"

1mm	250-420-231
2mm	250-420-232
3mm	250-420-233
4mm	250-420-234
5mm	250-420-235
6mm	250-420-236



90° downwards cutting
180mm, 7"

1mm	250-430-181
2mm	250-430-182
3mm	250-430-183
4mm	250-430-184
5mm	250-430-185
6mm	250-430-186

200mm, 8"

1mm	250-430-201
2mm	250-430-202
3mm	250-430-203
4mm	250-430-204
5mm	250-430-205
6mm	250-430-206

230mm, 9"

1mm	250-430-231
2mm	250-430-232
3mm	250-430-233
4mm	250-430-234
5mm	250-430-235
6mm	250-430-236

All Kerrison instruments are available with CERACUT® coating. Code number + CC (e.g. 250-400-181CC)

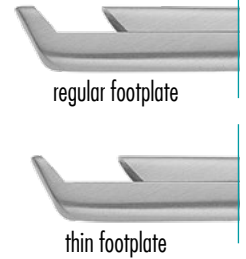
**KERRISON**

Punch, regular handle, thin footplate,
9.5mm opening

40° upwards cutting 180mm, 7"		90° upwards cutting 180mm, 7"		40° downwards cutting 180mm, 7"		90° downwards cutting 180mm, 7"	
1mm	250-401-181	1mm	250-411-181	1mm	250-421-181	1mm	250-431-181
2mm	250-401-182	2mm	250-411-182	2mm	250-421-182	2mm	250-431-182
3mm	250-401-183	3mm	250-411-183	3mm	250-421-183	3mm	250-431-183
4mm	250-401-184	4mm	250-411-184	4mm	250-421-184	4mm	250-431-184
5mm	250-401-185	5mm	250-411-185	5mm	250-421-185	5mm	250-431-185
200mm, 8"		200mm, 8"		200mm, 8"		200mm, 8"	
1mm	250-401-201	1mm	250-411-201	1mm	250-421-201	1mm	250-431-201
2mm	250-401-202	2mm	250-411-202	2mm	250-421-202	2mm	250-431-202
3mm	250-401-203	3mm	250-411-203	3mm	250-421-203	3mm	250-431-203
4mm	250-401-204	4mm	250-411-204	4mm	250-421-204	4mm	250-431-204
5mm	250-401-205	5mm	250-411-205	5mm	250-421-205	5mm	250-431-205
230mm, 9"		230mm, 9"		230mm, 9"		230mm, 9"	
1mm	250-401-231	1mm	250-411-231	1mm	250-421-231	1mm	250-431-231
2mm	250-401-232	2mm	250-411-231	2mm	250-421-231	2mm	250-431-231
3mm	250-401-233	3mm	250-411-231	3mm	250-421-231	3mm	250-431-231
4mm	250-401-234	4mm	250-411-231	4mm	250-421-231	4mm	250-431-231
5mm	250-401-235	5mm	250-411-231	5mm	250-421-231	5mm	250-431-231

ENT.



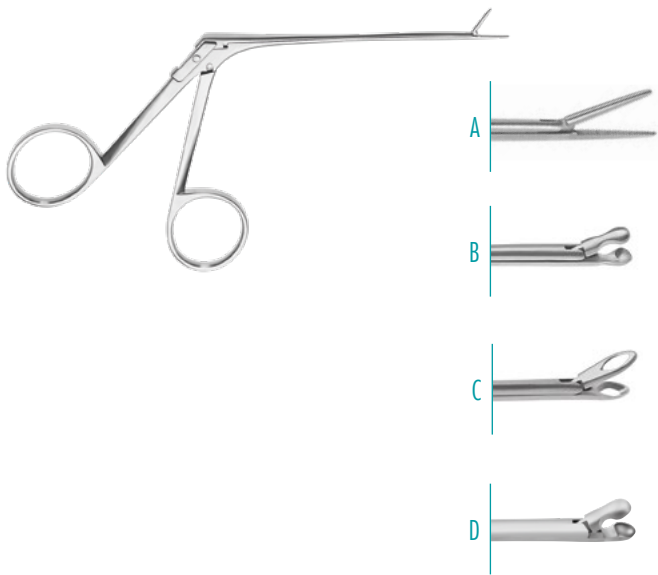

A Hartmann Aural Forceps, straight, serrated

1 x 8mm 410-210-085

B Hartmann-Herzfeld Ear Forceps, straight, 87mm working length

2.5mm spoon 410-338-136

C Struempel Ear Forceps, straight, 87mm working length

2.5 x 7.0mm 410-338-134

D Ormerod Micro Cupped Forceps, straight, round cup, 80mm working length

3.0 x 1.7mm 410-423-000

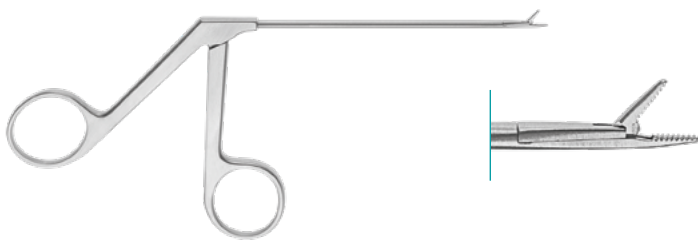

Micro Aural Forceps with tubular shaft, straight, 80mm working length

0.8 x 3.5mm 410-330-000



Troeltsch Aural Tissue Forceps, 1 x 2 teeth, knee bent

125mm 410-377-120



**House Curette, sharp, double ended,
oval cups, strongly curved, 1.0 x 1.2mm**
150mm 410-330-000



**Williger Double Curette, oval/oval
#0 / 1 (Ø 3.0 / 3.5mm)**
140mm 210-216-001



HALLE-TIECK
**Nasal Speculum, screw joint,
17.5mm blade length**
130mm 420-140-135

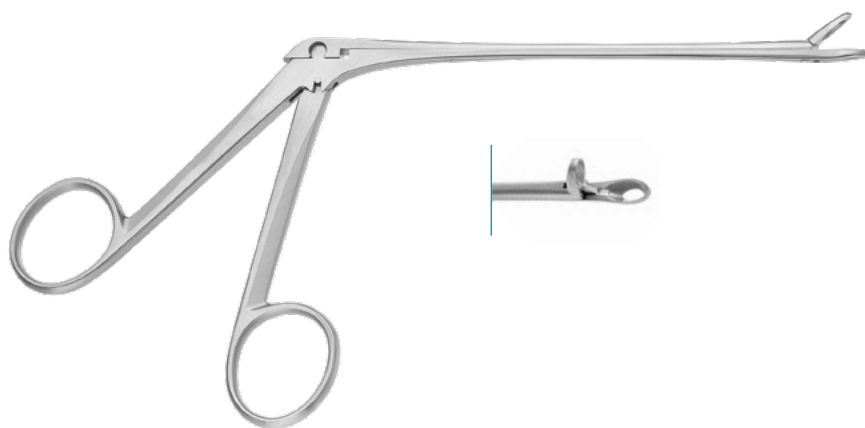

**Blakesley Nasal Forceps,
150mm working length**
3.5mm 252-035-150
4.0mm 252-040-150
5.0mm 252-050-150

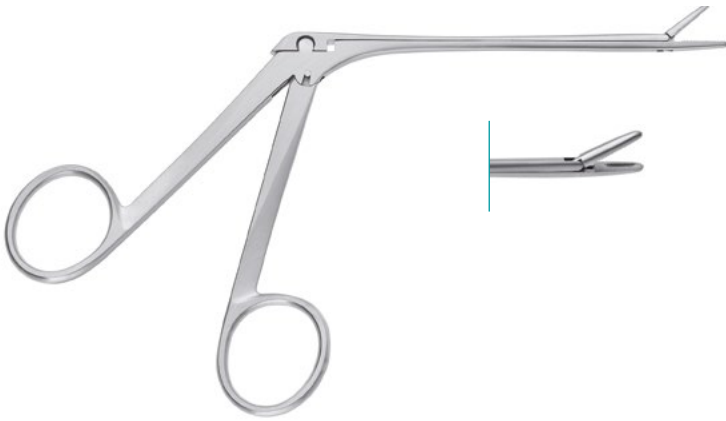

**Noyes Nasal Forceps,
115mm working length**

fenestrated jaw 252-527-115

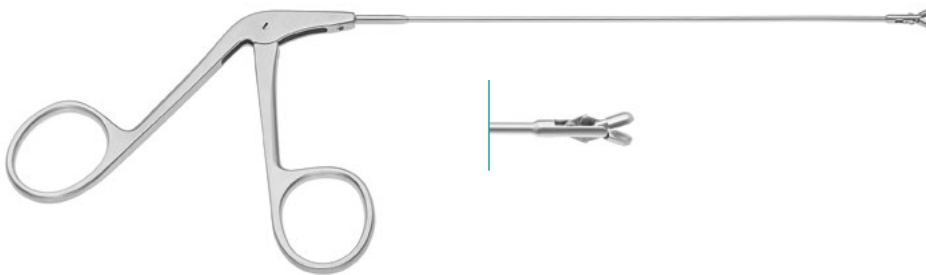

**Biopsy and Grasping Forceps,
delicate pattern,
140mm working length**

3mm oval cup 252-503-140



**Struempel Nasal Forceps with
oval fenestrated cupped jaws
120mm working length**

straight 252-031-120



Hurd Elevator

230mm 430-522-230



Green Retractor, 20 x 23mm

220mm 170-319-220



Lange Choana Hook

230mm 420-413-230



**Laryngeal mirror with hexagonal handle,
180mm**

Fig. 00, Ø 8mm 230-330-008
 Fig. 1, Ø 12mm 230-330-012
 Fig. 3, Ø 16mm 230-330-016
 Fig. 5, Ø 20mm 230-330-020

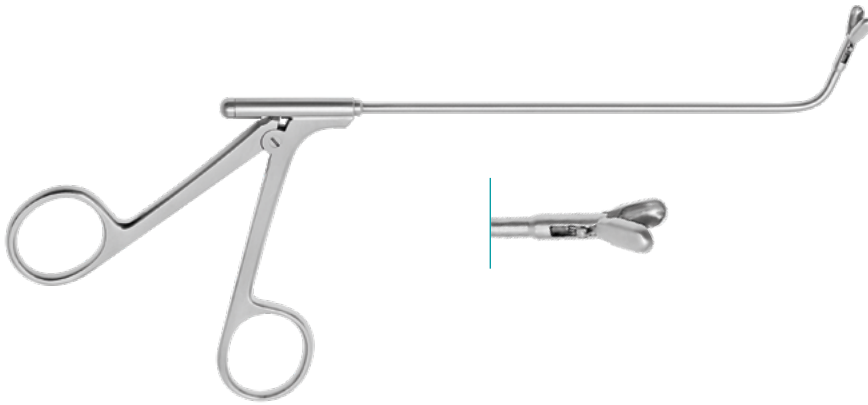

**Biopsy Forceps, vertical action,
70° curved up, 4 x 8mm
130mm working length**

70° curved up	252-670-120
110° curved backwards	252-770-120

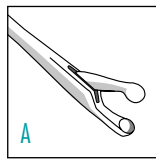
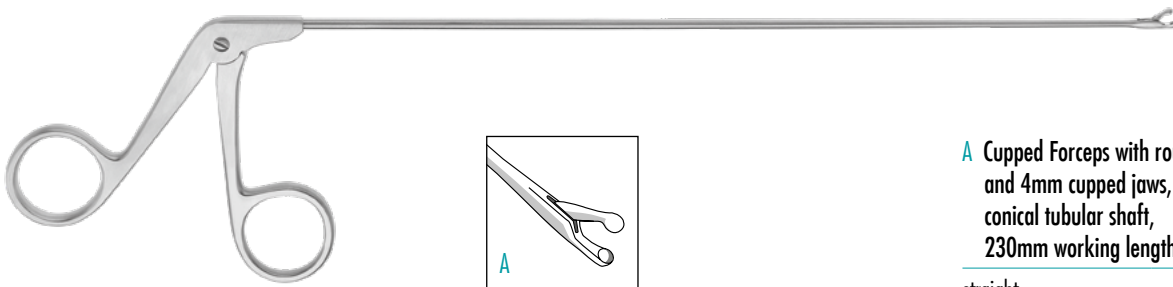

A Cupped Forceps with round 2mm and 4mm cupped jaws, conical tubular shaft, 230mm working length

straight	100-700-001
----------	-------------

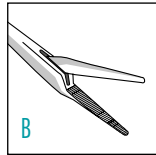

B Alligator Forceps, standard model, conical tubular shaft 2mm, 230mm working length

straight, serrated	100-700-020
--------------------	-------------

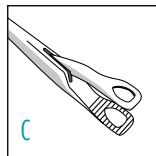

C Alligator Forceps, standard model, conical tubular shaft 2mm, triangular jaws, 230mm working length

straight	100-700-026
----------	-------------



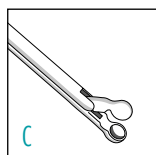
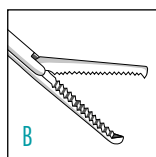
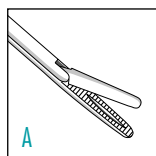
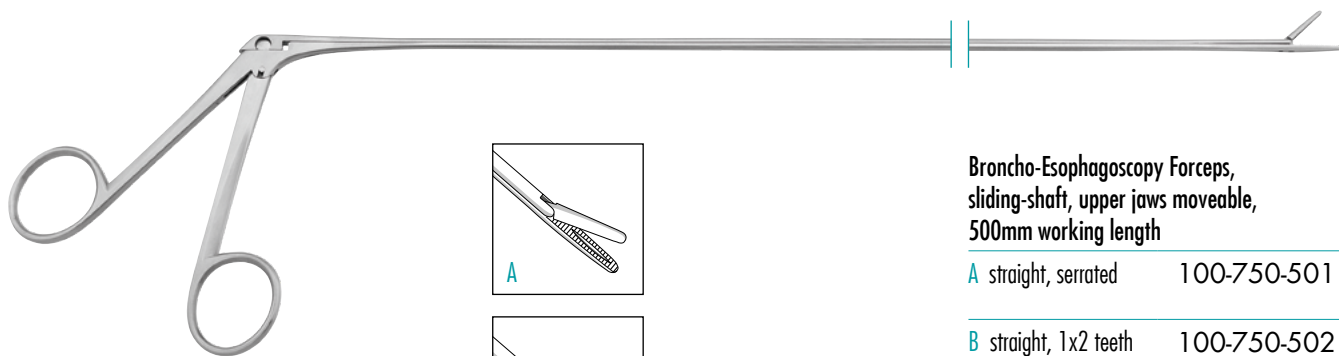

**Broncho-Esophagoscopy Forceps,
sliding-shaft, upper jaws moveable,
500mm working length**

- | | |
|-------------------------|-------------|
| A straight, serrated | 100-750-501 |
| B straight, 1x2 teeth | 100-750-502 |
| C straight, cupped jaws | 100-750-504 |

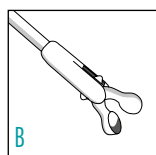
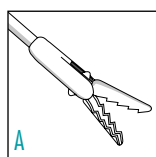
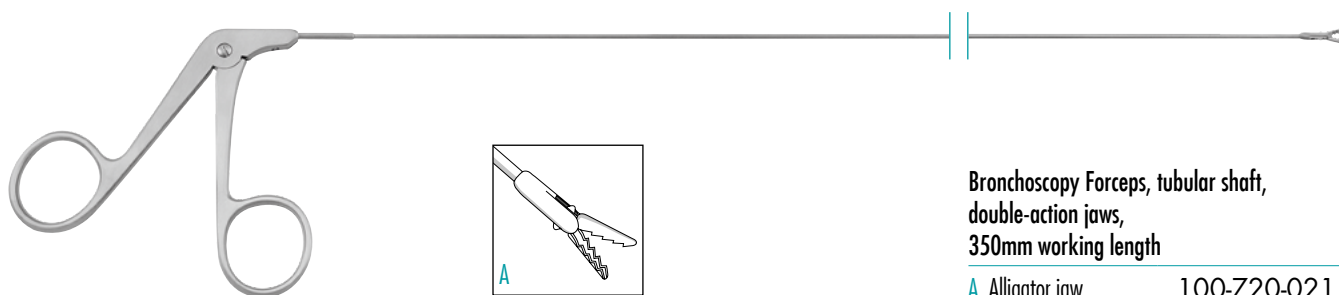

**Bronchoscopy Forceps, tubular shaft,
double-action jaws,
350mm working length**

- | | |
|-----------------------|-------------|
| A Alligator jaw | 100-720-021 |
| B straight, round cup | 100-720-023 |

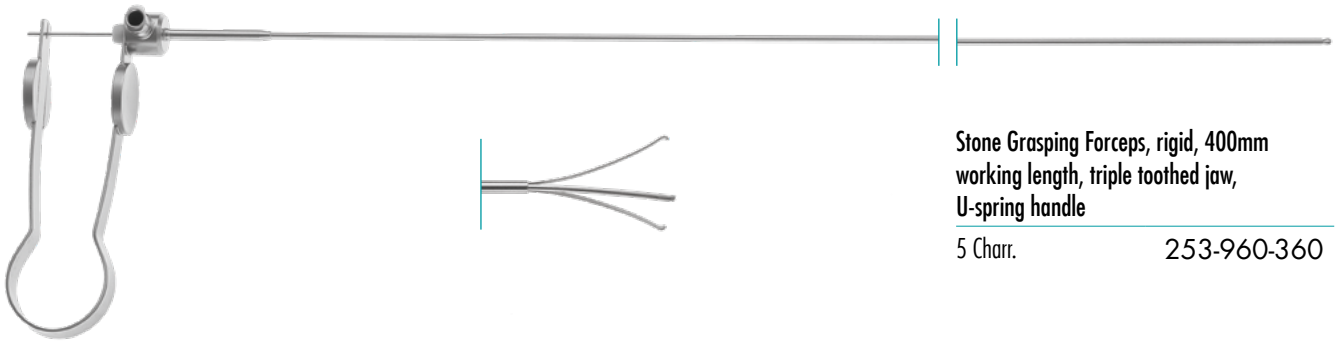

Stone Grasping Forceps, rigid, 400mm working length, triple toothed jaw, U-spring handle

5 Charr. 253-960-360

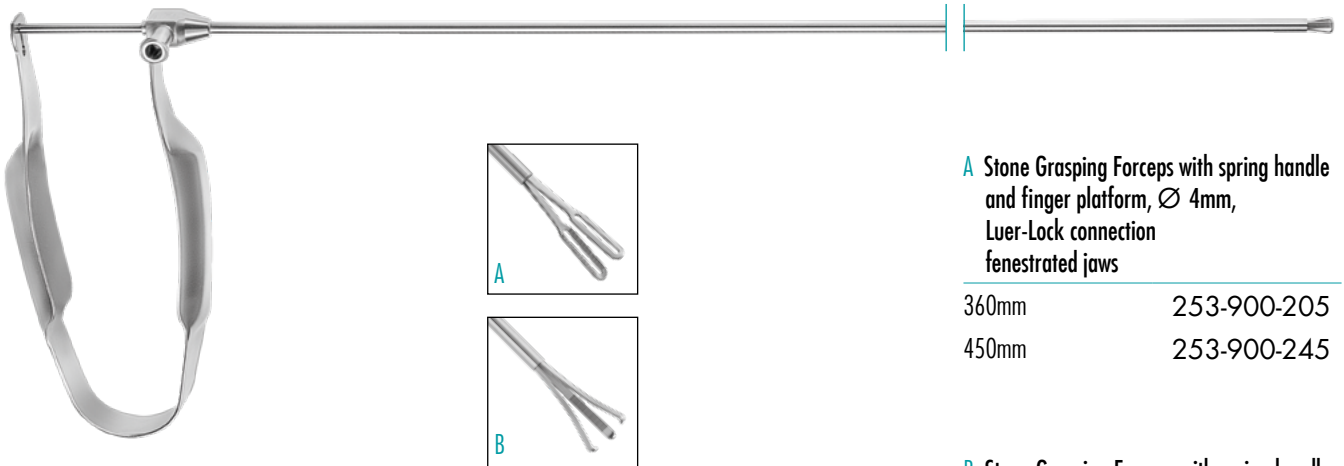

A Stone Grasping Forceps with spring handle and finger platform, Ø 4mm, Luer-Lock connection fenestrated jaws

360mm 253-900-205

450mm 253-900-245

B Stone Grasping Forceps with spring handle and finger platform, Ø 4mm, Luer-Lock connection, 3 prongs

360mm 253-900-206

450mm 253-900-246



