

# index.

<b>scissors.</b>	3 - 20
<b>dressing &amp; tissue forceps.</b>	21 - 34
<b>clamps and forceps.</b>	35 - 46
<b>needle holders.</b>	47 - 58
<b>retractors.</b>	59 - 68
<b>skin and wound.</b>	69 - 74
<b>orthopaedics.</b>	75 - 110
<b>ENT.</b>	111 - 118





# scissors.





Fig. 1



Fig. 2

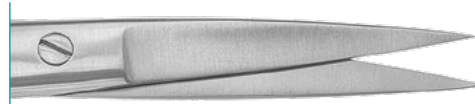

Fig. 3

**STANDARD****Fig. 1 (blunt/blunt), straight**

115mm, 4 <sup>1</sup> / <sub>2</sub> "	120-010-115
130mm, 5 <sup>1</sup> / <sub>8</sub> "	120-010-130
145mm, 5 <sup>3</sup> / <sub>4</sub> "	120-010-145
155mm, 6 <sup>1</sup> / <sub>8</sub> "	120-010-155
165mm, 6 <sup>1</sup> / <sub>2</sub> "	120-010-165
175mm, 6 <sup>7</sup> / <sub>8</sub> "	120-010-175
185mm, 7 <sup>1</sup> / <sub>4</sub> "	120-010-185
200mm, 8"	120-010-200

**curved**

115mm, 4 <sup>1</sup> / <sub>2</sub> "	120-011-115
130mm, 5 <sup>1</sup> / <sub>8</sub> "	120-011-130
145mm, 5 <sup>3</sup> / <sub>4</sub> "	120-011-145
155mm, 6 <sup>1</sup> / <sub>8</sub> "	120-011-155
165mm, 6 <sup>1</sup> / <sub>2</sub> "	120-011-165
175mm, 6 <sup>7</sup> / <sub>8</sub> "	120-011-175
185mm, 7 <sup>1</sup> / <sub>4</sub> "	120-011-185
200mm, 8"	120-011-200

**Fig. 2 (sharp/blunt), straight**

115mm, 4 <sup>1</sup> / <sub>2</sub> "	120-012-115
130mm, 5 <sup>1</sup> / <sub>8</sub> "	120-012-130
145mm, 5 <sup>3</sup> / <sub>4</sub> "	120-012-145
155mm, 6 <sup>1</sup> / <sub>8</sub> "	120-012-155
165mm, 6 <sup>1</sup> / <sub>2</sub> "	120-012-165
175mm, 6 <sup>7</sup> / <sub>8</sub> "	120-012-175
185mm, 7 <sup>1</sup> / <sub>4</sub> "	120-012-185
200mm, 8"	120-012-200

**curved**

115mm, 4 <sup>1</sup> / <sub>2</sub> "	120-013-115
130mm, 5 <sup>1</sup> / <sub>8</sub> "	120-013-130
145mm, 5 <sup>3</sup> / <sub>4</sub> "	120-013-145
155mm, 6 <sup>1</sup> / <sub>8</sub> "	120-013-155
165mm, 6 <sup>1</sup> / <sub>2</sub> "	120-013-165
175mm, 6 <sup>7</sup> / <sub>8</sub> "	120-013-175
185mm, 7 <sup>1</sup> / <sub>4</sub> "	120-013-185
200mm, 8"	120-013-200

**Fig. 3 (sharp/sharp), straight**

115mm, 4 <sup>1</sup> / <sub>2</sub> "	120-014-115
130mm, 5 <sup>1</sup> / <sub>8</sub> "	120-014-130
145mm, 5 <sup>3</sup> / <sub>4</sub> "	120-014-145
155mm, 6 <sup>1</sup> / <sub>8</sub> "	120-014-155
165mm, 6 <sup>1</sup> / <sub>2</sub> "	120-014-165

**curved**

115mm, 4 <sup>1</sup> / <sub>2</sub> "	120-015-115
130mm, 5 <sup>1</sup> / <sub>8</sub> "	120-015-130
145mm, 5 <sup>3</sup> / <sub>4</sub> "	120-015-145
155mm, 6 <sup>1</sup> / <sub>8</sub> "	120-015-155
165mm, 6 <sup>1</sup> / <sub>2</sub> "	120-015-165





**MAYO**  
straight

145mm, 5 <sup>3</sup> / <sub>4</sub> "	120-030-145
150mm, 6"	120-030-150
170mm, 6 <sup>2</sup> / <sub>3</sub> "	120-030-170

curved

145mm, 5 <sup>3</sup> / <sub>4</sub> "	120-031-145
150mm, 6"	120-031-150
170mm, 6 <sup>2</sup> / <sub>3</sub> "	120-031-170



**MAYO STILLE**  
straight

150mm, 6"	120-036-150
170mm, 6 <sup>2</sup> / <sub>3</sub> "	120-036-170
195mm, 7 <sup>3</sup> / <sub>4</sub> "	120-036-195
210mm, 8 <sup>1</sup> / <sub>4</sub> "	120-036-210

curved

150mm, 6"	120-037-150
170mm, 6 <sup>2</sup> / <sub>3</sub> "	120-037-170
195mm, 7 <sup>3</sup> / <sub>4</sub> "	120-037-195
210mm, 8 <sup>1</sup> / <sub>4</sub> "	120-037-210



**BABY METZENBAUM**  
straight

115mm, 4 <sup>1</sup> / <sub>2</sub> "	120-110-115
--	-------------

curved

115mm, 4 <sup>1</sup> / <sub>2</sub> "	120-111-115
--	-------------



**METZENBAUM**  
straight

145mm, 5 <sup>3</sup> / <sub>4</sub> "	120-110-145
160mm, 6 <sup>1</sup> / <sub>4</sub> "	120-110-160

curved

145mm, 5 <sup>3</sup> / <sub>4</sub> "	120-111-145
160mm, 6 <sup>1</sup> / <sub>4</sub> "	120-111-160

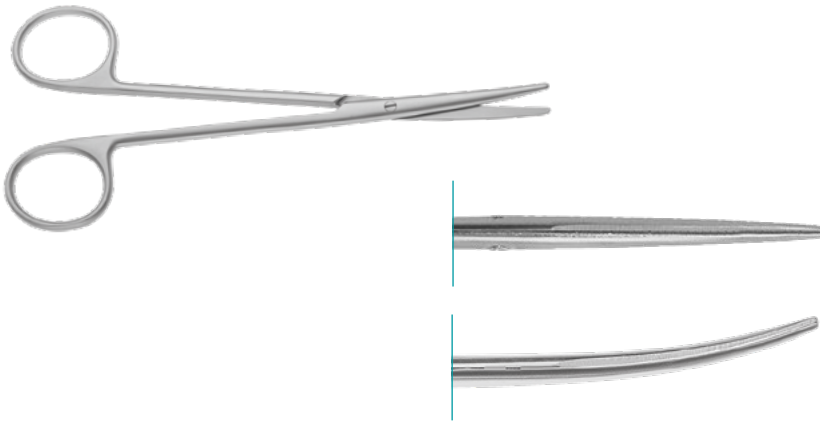
**METZENBAUM FINO****straight**

145mm, 5 <sup>3</sup> / <sub>4</sub> "	120-152-145
180mm, 7"	120-152-180
200mm, 8"	120-152-200
230mm, 9"	120-152-230

**curved**

145mm, 5 <sup>3</sup> / <sub>4</sub> "	120-153-145
180mm, 7"	120-153-180
200mm, 8"	120-153-200
230mm, 9"	120-153-230

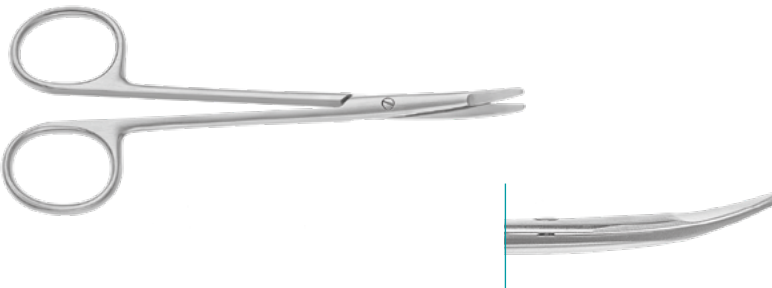
**KILNER RAGNELL****curved, blunt**

130mm, 5 <sup>1</sup> / <sub>8</sub> "	120-065-130
150mm, 6"	120-065-150
180mm, 7"	120-065-180
200mm, 8"	120-065-200
230mm, 9"	120-065-230

**JAMESON****curved, blunt**

150mm, 6"	120-315-150
180mm, 7"	120-315-180
200mm, 8"	120-315-200
230mm, 9"	120-315-230



**LISTER**  
Bandage Scissors

90mm, 3 <sup>1</sup> / <sub>2</sub> "	190-165-090
110mm, 4 <sup>1</sup> / <sub>3</sub> "	190-165-110
140mm, 5 <sup>1</sup> / <sub>2</sub> "	190-165-140
180mm, 7"	190-165-180
200mm, 8"	190-165-200



**LISTER**  
Bandage Scissors with 1 large ring

210mm, 8 <sup>1</sup> / <sub>4</sub> "	190-170-210
--	-------------



**BERGMANN**  
Plaster Scissors

230mm, 9"	190-195-230
-----------	-------------





**UNIVERSAL**  
small, 140mm, 5 1/2"

black	190-209-151
red	190-209-152
yellow	190-209-153
green	190-209-154



**UNIVERSAL**  
large, 180mm, 7"

blue	190-209-180
black	190-209-181
red	190-209-182
yellow	190-209-183
green	190-209-184
orange	190-209-185





**SPENCER**

**Suture Scissors, straight**

90mm, 3 <sup>1</sup> / <sub>2</sub> "	120-220-090
130mm, 5 <sup>1</sup> / <sub>8</sub> "	120-220-130

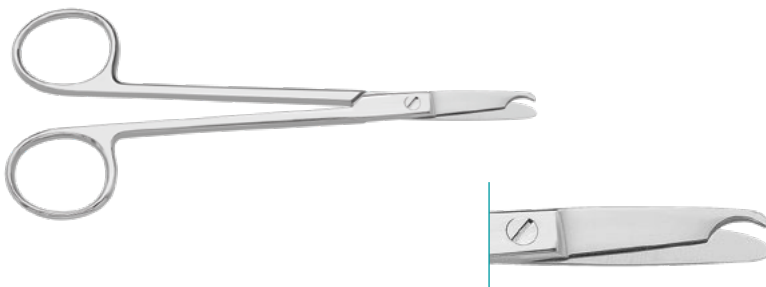

**LITTAUER**

**Ligature Scissors, straight**

115mm, 4 <sup>1</sup> / <sub>2</sub> "	120-224-115
140mm, 5 <sup>1</sup> / <sub>2</sub> "	120-224-140



**Ligature Scissors, SC, TC inserts, curved, serrated blades**

115mm, 4 <sup>1</sup> / <sub>2</sub> "	120-611-115
140mm, 5 <sup>1</sup> / <sub>2</sub> "	120-611-140
180mm, 7"	120-611-180
230mm, 9"	120-611-230



**Iris Scissors, straight**

90mm, 3 <sup>1</sup> / <sub>2</sub> "	120-070-090
105mm, 4 <sup>1</sup> / <sub>8</sub> "	120-070-105
115mm, 4 <sup>1</sup> / <sub>2</sub> "	120-070-115

**curved**

90mm, 3 <sup>1</sup> / <sub>2</sub> "	120-071-090
105mm, 4 <sup>1</sup> / <sub>8</sub> "	120-071-105
115mm, 4 <sup>1</sup> / <sub>2</sub> "	120-071-115



**Iris Scissors, square model, 120mm, 4<sup>3</sup>/<sub>4</sub>"**

straight	120-086-120
curved	120-087-120



**Iris Scissors, angled to side**

115mm, 4 <sup>1</sup> / <sub>2</sub> "	120-085-115
--	-------------





**Wire Cutting Scissors, serrated**

120mm, 4<sup>3</sup>/<sub>4</sub>" 120-265-120



**HARVEY**

Wire Cutting Scissors, both serrated blade, straight

125mm, 5" 120-262-125

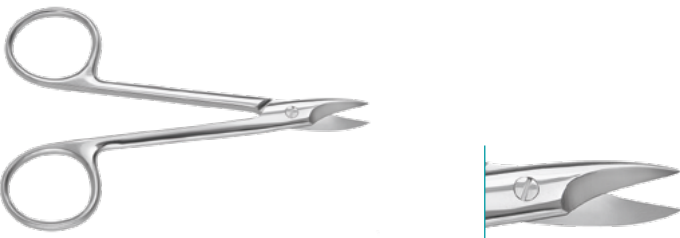

**Crown & Collar Scissors, straight, serrated**

100mm, 4" 120-296-100

120mm, 4<sup>3</sup>/<sub>4</sub>" 120-296-120

**curved**

100mm, 4" 120-297-100

120mm, 4<sup>3</sup>/<sub>4</sub>" 120-297-120

**Iris Scissors, 105mm, 4<sup>1</sup>/<sub>8</sub>"**

straight	120-080-105
curved	120-081-105

**115mm, 4<sup>1</sup>/<sub>2</sub>"**

straight	120-080-115
curved	120-081-115

**KNAPP****Strabismus Scissors, blunt, 105mm, 4<sup>1</sup>/<sub>8</sub>"**

straight	400-112-105
curved	400-113-105

**STEVENS****A Tenotomy Scissors, ring handle, blunt, straight**

105mm, 4 <sup>1</sup> / <sub>8</sub> "	120-092-105
115mm, 4 <sup>1</sup> / <sub>2</sub> "	120-092-115
125mm, 5"	120-092-125

**B blunt, curved**

90mm, 3 <sup>1</sup> / <sub>2</sub> "	120-093-090
105mm, 4 <sup>1</sup> / <sub>8</sub> "	120-093-105
115mm, 4 <sup>1</sup> / <sub>2</sub> "	120-093-115
125mm, 5"	120-093-125

**C sharp, straight**

105mm, 4 <sup>1</sup> / <sub>8</sub> "	120-090-105
115mm, 4 <sup>1</sup> / <sub>2</sub> "	120-090-115
125mm, 5"	120-090-125

**D sharp, curved**

105mm, 4 <sup>1</sup> / <sub>8</sub> "	120-091-105
115mm, 4 <sup>1</sup> / <sub>2</sub> "	120-091-115
125mm, 5"	120-091-125

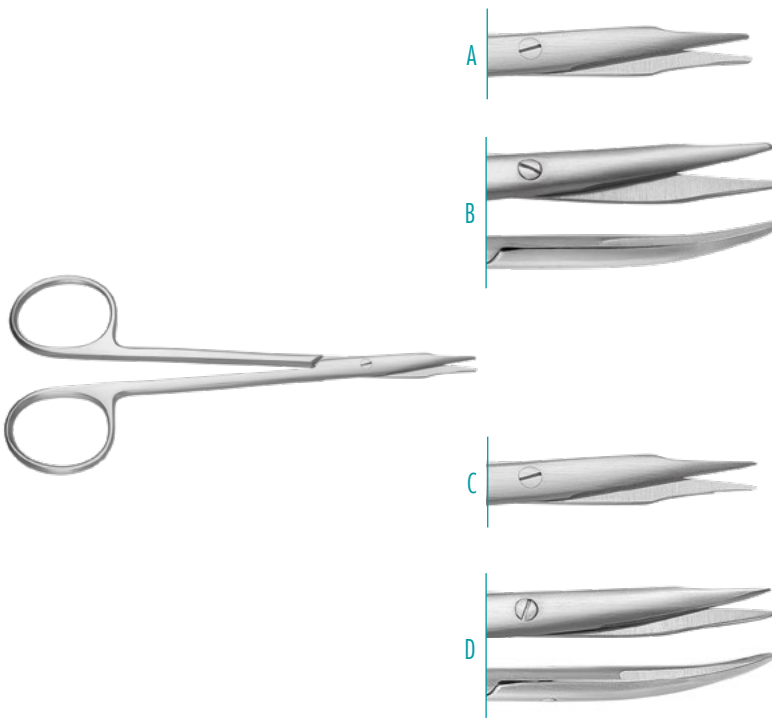





**MAYO SC**  
Surgical Scissors, straight

145mm, 5 <sup>3</sup> / <sub>4</sub> "	121-030-145
170mm, 6 <sup>2</sup> / <sub>3</sub> "	121-030-170
230mm, 9"	121-030-230

**curved**

145mm, 5 <sup>3</sup> / <sub>4</sub> "	121-031-145
170mm, 6 <sup>2</sup> / <sub>3</sub> "	121-031-170
230mm, 9"	121-031-230

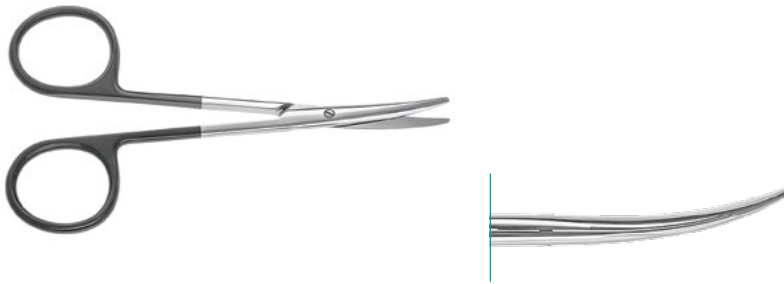

**METZENBAUM BABY SC**  
Dissecting Scissors, curved

110mm, 4 <sup>1</sup> / <sub>3</sub> "	121-317-110
145mm, 5 <sup>3</sup> / <sub>4</sub> "	121-317-145





**STRABISMUS SC**  
Dissecting Scissors, 115mm, 4<sup>1</sup>/<sub>2</sub>"

---

straight	121-094-115
curved	121-095-115



**METZENBAUM SC**  
145mm, 5<sup>3</sup>/<sub>4</sub>"

---

straight	121-110-145
curved	121-111-145

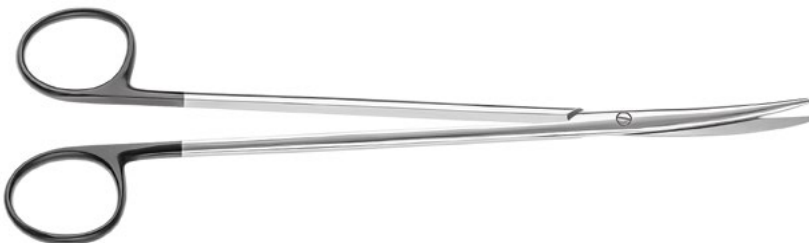

**METZENBAUM FINO SC**  
curved, blunt

---

115mm, 4 <sup>1</sup> / <sub>2</sub> "	121-153-115
145mm, 5 <sup>3</sup> / <sub>4</sub> "	121-153-145
180mm, 7"	121-153-180
200mm, 8"	121-153-200
230mm, 9"	121-153-230

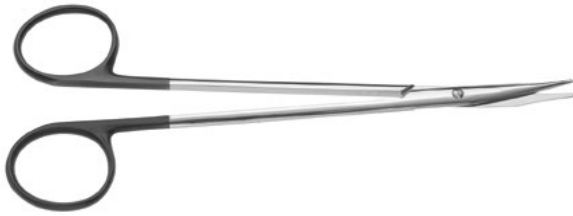

**JAMESON SC**  
curved, blunt

150mm, 6"	121-315-150
180mm, 7"	121-315-180

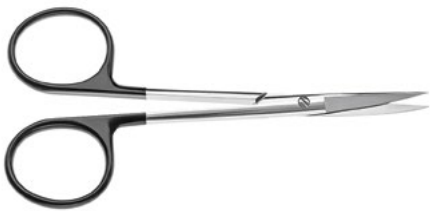

**IRIS SC**  
sharp, 110mm, 4<sup>1</sup>/<sub>3</sub>"

straight	121-070-110
curved	121-071-110



**STEVENS SC**  
Tenotomy Scissors, square model,  
blunt, straight

105mm, 4 <sup>1</sup> / <sub>8</sub> "	121-196-100
115mm, 4 <sup>1</sup> / <sub>2</sub> "	121-196-110
125mm, 5"	121-196-120

**curved**

105mm, 4 <sup>1</sup> / <sub>8</sub> "	121-197-100
115mm, 4 <sup>1</sup> / <sub>2</sub> "	121-197-110
125mm, 5"	121-197-120

**STANDARD TC**straight, 145mm, 5<sup>3</sup>/<sub>4</sub>"

Fig. 1 (blunt/blunt)	120-500-145
-------------------------	-------------

curved, 145mm, 5<sup>3</sup>/<sub>4</sub>"

Fig. 1 (blunt/blunt)	120-501-145
-------------------------	-------------

straight, 145mm, 5<sup>3</sup>/<sub>4</sub>"

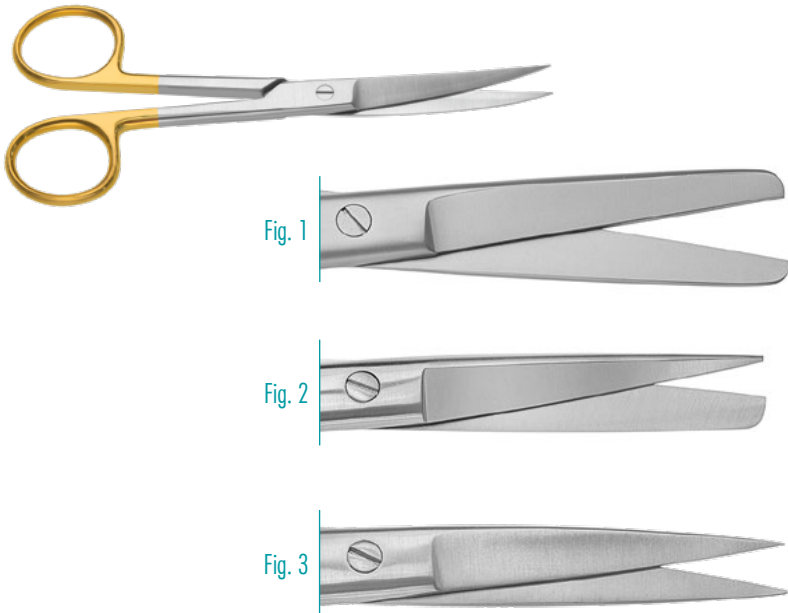
Fig. 2 (sharp/blunt)	120-502-145
-------------------------	-------------

Fig. 3 (sharp/sharp)	120-504-145
-------------------------	-------------

curved, 145mm, 5<sup>3</sup>/<sub>4</sub>"

Fig. 2 (sharp/blunt)	120-503-145
-------------------------	-------------

Fig. 3 (sharp/sharp)	120-505-145
-------------------------	-------------

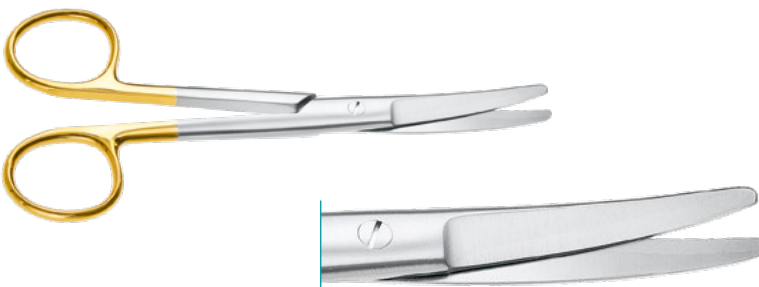
**MAYO TC**

straight

145mm, 5 <sup>3</sup> / <sub>4</sub> "	120-506-145
--	-------------

170mm, 6 <sup>2</sup> / <sub>3</sub> "	120-506-170
--	-------------

curved

145mm, 5 <sup>3</sup> / <sub>4</sub> "	120-507-145
--	-------------

170mm, 6 <sup>2</sup> / <sub>3</sub> "	120-507-170
--	-------------

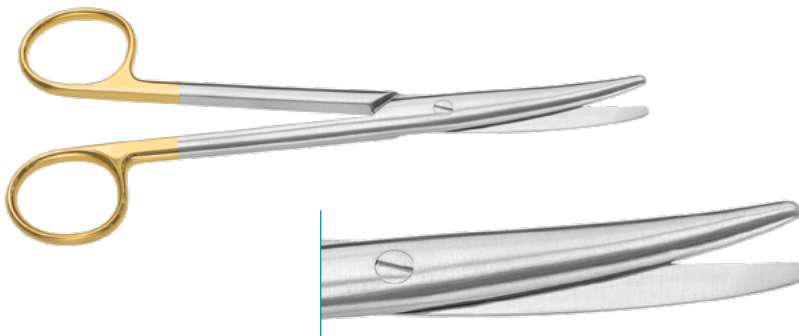
**MAYO STILLE TC**

straight

150mm, 6"	120-508-150
-----------	-------------

170mm, 6 <sup>2</sup> / <sub>3</sub> "	120-508-170
--	-------------

curved

150mm, 6"	120-509-150
-----------	-------------

170mm, 6 <sup>2</sup> / <sub>3</sub> "	120-507-170
--	-------------



**TOENNIS ADSON TC**

curved

170mm, 6<sup>2</sup>/<sub>3</sub>"

120-531-170



**METZENBAUM BABY TC**

straight, blunt

115mm, 4<sup>1</sup>/<sub>2</sub>"

120-510-115

curved, blunt

115mm, 4<sup>1</sup>/<sub>2</sub>"

120-511-115



**BABY METZENBAUM TC**

Strabismus Scissors, straight

115mm, 4<sup>1</sup>/<sub>2</sub>"

120-594-115

curved

115mm, 4<sup>1</sup>/<sub>2</sub>"

120-595-115



**METZENBAUM TC**

straight, blunt/blunt

145mm, 5<sup>3</sup>/<sub>4</sub>"

120-510-145

180mm, 7"

120-510-180

200mm, 8"

120-510-200

230mm, 9"

120-510-230

curved

145mm, 5<sup>3</sup>/<sub>4</sub>"

120-511-145

180mm, 7"

120-511-180

200mm, 8"

120-511-200

230mm, 9"

120-511-230

**METZENBAUM FINO TC****straight, blunt/blunt**

145mm, 5 <sup>3</sup> / <sub>4</sub> "	120-520-145
180mm, 7"	120-520-180
200mm, 8"	120-520-200
230mm, 9"	120-520-230

**curved, blunt/blunt**

145mm, 5 <sup>3</sup> / <sub>4</sub> "	120-521-145
180mm, 7"	120-521-180
200mm, 8"	120-521-200
230mm, 9"	120-521-230

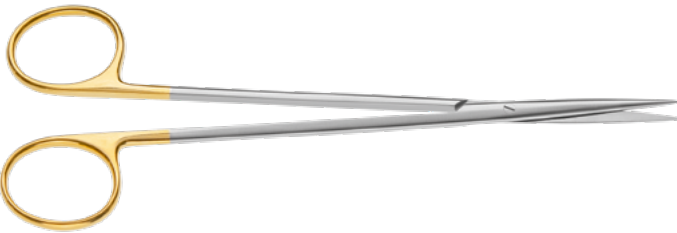
**METZENBAUM FINO TC****straight, sharp/sharp**

145mm, 5 <sup>3</sup> / <sub>4</sub> "	120-522-145
180mm, 7"	120-522-180
200mm, 8"	120-522-200
230mm, 9"	120-522-230

**curved, sharp/sharp**

145mm, 5 <sup>3</sup> / <sub>4</sub> "	120-523-145
180mm, 7"	120-523-180
200mm, 8"	120-523-200
230mm, 9"	120-523-230

**straight, blunt**

180mm, 7"	120-525-180
200mm, 8"	120-525-200

**IRIS TC****straight**

115mm, 4 <sup>1</sup> / <sub>2</sub> "	120-554-115
--	-------------

**curved**

115mm, 4 <sup>1</sup> / <sub>2</sub> "	120-555-115
--	-------------



**STEVENS CERACUT®**  
Dissecting Scissors, straight, square rings  
115mm, 4<sup>1/2</sup>"

sharp	123-184-115
blunt	123-182-115



**IRIS CERACUT®**  
115mm, 4<sup>1/2</sup>"

straight	123-070-115
curved	123-071-115



**BABY METZENBAUM CERACUT®**  
curved

110mm, 4 <sup>1/3</sup> "	123-317-110
145mm, 5 <sup>3/4</sup> "	123-317-145



**MAYO CERACUT®**  
straight

145mm, 5 <sup>3/4</sup> "	123-030-145
170mm, 6 <sup>2/3</sup> "	123-030-170

curved

145mm, 5 <sup>3/4</sup> "	123-031-145
170mm, 6 <sup>2/3</sup> "	123-031-170





# dressing & tissue forceps.

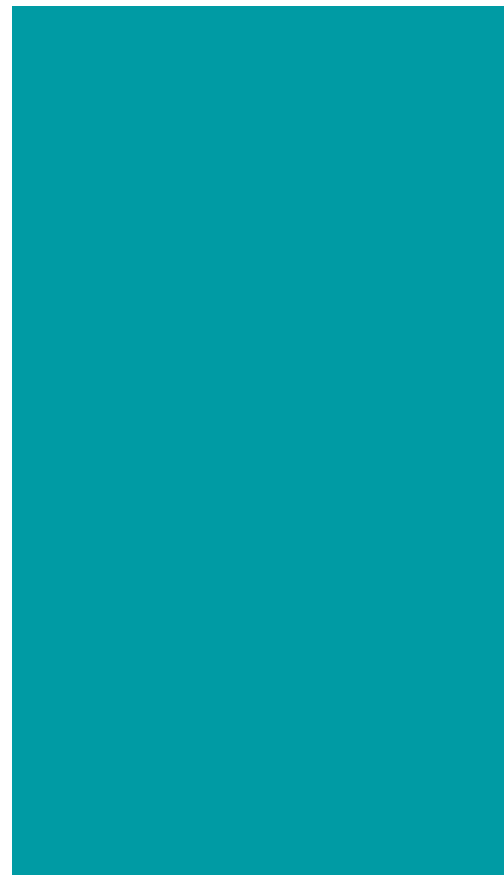

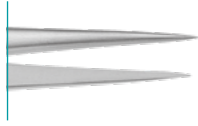

**Delicate Forceps, smooth, straight**

100mm, 4"	130-437-100
-----------	-------------



**Delicate Forceps, smooth, angled**

100mm, 4"	130-438-100
-----------	-------------



**Plain Splinter Forceps**

90mm, 3 1/2"	130-622-090
--------------	-------------

115mm, 4 1/2"	130-622-115
---------------	-------------



**BISHOP HARMON**

**Iris Forceps, 1x 2 teeth, straight, 85mm, 3 1/3"**

0.3mm	400-118-003
-------	-------------

0.4mm	400-118-004
-------	-------------

0.5mm	400-118-005
-------	-------------

0.8mm	400-118-008
-------	-------------

**serrated**

0.5mm	400-018-005
-------	-------------

0.8mm, cross-serrated	400-019-008
--------------------------	-------------





**Dressing Forceps, serrated**

105mm, 4 <sup>1</sup> / <sub>8</sub> "	130-010-105
115mm, 4 <sup>1</sup> / <sub>2</sub> "	130-010-115
130mm, 5 <sup>1</sup> / <sub>8</sub> "	130-010-130
145mm, 5 <sup>3</sup> / <sub>4</sub> "	130-010-145
150mm, 6"	130-010-150
160mm, 6 <sup>1</sup> / <sub>4</sub> "	130-010-160
180mm, 7"	130-010-180
200mm, 8"	130-010-200
230mm, 9"	130-010-230
250mm, 9 <sup>7</sup> / <sub>8</sub> "	130-010-250
300mm, 11 <sup>7</sup> / <sub>8</sub> "	130-010-300



**Dressing Forceps, cross-serrated**

130mm, 5 <sup>1</sup> / <sub>8</sub> "	130-011-130
145mm, 5 <sup>3</sup> / <sub>4</sub> "	130-011-145
160mm, 6 <sup>1</sup> / <sub>4</sub> "	130-011-160



**Standard Dressing Forceps, slender, curved**

105mm, 4 <sup>1</sup> / <sub>8</sub> "	130-013-105
115mm, 4 <sup>1</sup> / <sub>2</sub> "	130-013-115
130mm, 5 <sup>1</sup> / <sub>8</sub> "	130-013-130
145mm, 5 <sup>3</sup> / <sub>4</sub> "	130-013-145



**STANDARD**

**Dressing Forceps, delicate tip, serrated**

105mm, 4 <sup>1</sup> / <sub>8</sub> "	130-012-105
115mm, 4 <sup>1</sup> / <sub>2</sub> "	130-012-115
130mm, 5 <sup>1</sup> / <sub>8</sub> "	130-012-130
145mm, 5 <sup>3</sup> / <sub>4</sub> "	130-012-145
160mm, 6 <sup>1</sup> / <sub>4</sub> "	130-012-160
180mm, 7"	130-012-180
200mm, 8"	130-012-200
250mm, 9 <sup>7</sup> / <sub>8</sub> "	130-012-250
300mm, 11 <sup>7</sup> / <sub>8</sub> "	130-012-300



**Standard Dressing Forceps, delicate tip, serrated, curved**

105mm, 4 <sup>1</sup> / <sub>8</sub> "	130-015-105
115mm, 4 <sup>1</sup> / <sub>2</sub> "	130-015-115
130mm, 5 <sup>1</sup> / <sub>8</sub> "	130-015-130
145mm, 5 <sup>3</sup> / <sub>4</sub> "	130-015-145



**POTTS SMITH**

**Dressing Forceps, straight**

180mm, 7"	130-038-180
210mm, 8 <sup>1</sup> / <sub>4</sub> "	130-038-210
250mm, 9 <sup>7</sup> / <sub>8</sub> "	130-038-250

**curved**

180mm, 7"	130-037-180
210mm, 8 <sup>1</sup> / <sub>4</sub> "	130-037-210
250mm, 9 <sup>7</sup> / <sub>8</sub> "	130-037-250

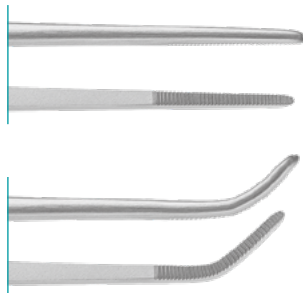

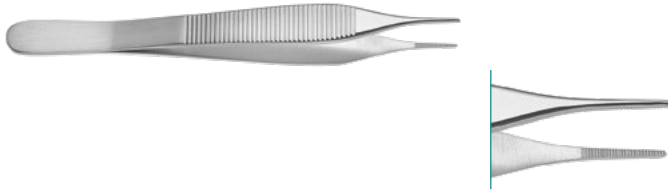

**MICRO ADSON**

Dressing Forceps, serrated

120mm, 4<sup>3</sup>/<sub>4</sub>" 130-548-120

150mm, 6" 130-548-150



**ADSON**

Dressing Forceps, smooth

120mm, 4<sup>3</sup>/<sub>4</sub>" 130-025-120



**ADSON**

Dressing Forceps, serrated

120mm, 4<sup>3</sup>/<sub>4</sub>" 130-026-120

150mm, 6" 130-026-150

180mm, 7" 130-026-180



**ADSON**

Dressing Forceps, cross-serrated

120mm, 4<sup>3</sup>/<sub>4</sub>" 130-029-120



**GERALD**

Dressing Forceps, narrow,  
1.2mm step-down-tip, serrated

Straight, 180mm, 7"	130-034-180
Straight, 230mm, 9"	130-034-230
Curved, 180mm, 7"	130-035-180
Curved, 230mm, 9"	130-035-230
Bayonet, 190mm, 7 <sup>1/2</sup> "	130-041-180



**SEMKEN**

Dressing Forceps, cross-serrated

125mm, 5"	130-144-125
150mm, 6"	130-144-150



**TAYLOR**

Dressing Forceps, bayonet,  
serrated with dissector end

185mm, 7 <sup>1/4</sup> "	130-035-185
---------------------------	-------------



**ADSON**  
Tissue Forceps, 1x2 teeth

120mm, 4 <sup>3</sup> / <sub>4</sub> "	130-140-120
150mm, 6"	130-140-150
180mm, 7"	130-140-180

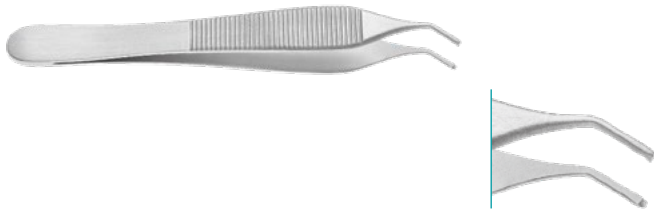

**ADSON**  
Tissue Forceps, 1x2 teeth, angled

120mm, 4 <sup>3</sup> / <sub>4</sub> "	130-143-120
--	-------------



**MICRO ADSON**  
Tissue Forceps, 1x2 teeth, 0.8mm tip

120mm, 4 <sup>3</sup> / <sub>4</sub> "	130-550-120
150mm, 6"	130-550-150



**ADSON**

Tissue Forceps, 1x2 teeth, with tying platform, 120mm, 4<sup>3</sup>/<sub>4</sub>"

0.9mm tip	130-141-009
1.0mm tip	130-141-010
1.2mm tip	130-141-012



**EWALD ADSON**

Tissue Forceps, 1x2 teeth

120mm, 4 <sup>3</sup> / <sub>4</sub> "	130-142-120
--	-------------



**ADSON**

Tissue Forceps, 2x3 teeth

120mm, 4 <sup>3</sup> / <sub>4</sub> "	130-555-120
150mm, 6"	130-555-150

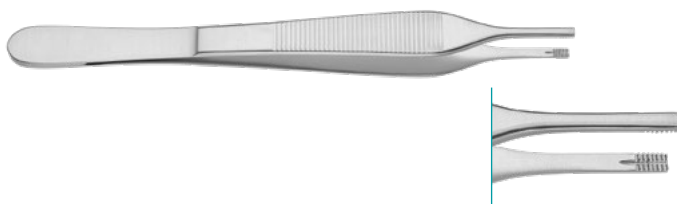

**ADSON BROWN**

Tissue Forceps, 7x7 teeth

120mm, 4 <sup>3</sup> / <sub>4</sub> "	130-552-120
150mm, 6"	130-552-150





**Tissue Forceps, 1x2 teeth**

105mm, 4 <sup>1</sup> / <sub>8</sub> "	130-110-105
115mm, 4 <sup>1</sup> / <sub>2</sub> "	130-110-115
130mm, 5 <sup>1</sup> / <sub>8</sub> "	130-110-130
145mm, 5 <sup>3</sup> / <sub>4</sub> "	130-110-145
150mm, 6"	130-110-150
160mm, 6 <sup>1</sup> / <sub>4</sub> "	130-110-160
180mm, 7"	130-110-180
200mm, 8"	130-110-200
230mm, 9"	130-110-230
250mm, 9 <sup>7</sup> / <sub>8</sub> "	130-110-250
300mm, 11 <sup>7</sup> / <sub>8</sub> "	130-110-300



**Tissue Forceps, 1x2 teeth, delicate**

115mm, 4 <sup>1</sup> / <sub>2</sub> "	130-120-115
130mm, 5 <sup>1</sup> / <sub>8</sub> "	130-120-130
145mm, 5 <sup>3</sup> / <sub>4</sub> "	130-120-145
160mm, 6 <sup>1</sup> / <sub>4</sub> "	130-120-160
180mm, 7"	130-120-180
200mm, 8"	130-120-200
250mm, 9 <sup>7</sup> / <sub>8</sub> "	130-120-250
300mm, 11 <sup>7</sup> / <sub>8</sub> "	130-120-300



**Tissue Forceps**

2x3teeth, 145mm, 5 <sup>3</sup> / <sub>4</sub> "	130-112-145
2x3teeth, 160mm, 6 <sup>1</sup> / <sub>4</sub> "	130-112-160
3x4teeth, 145mm, 5 <sup>3</sup> / <sub>4</sub> "	130-114-145
3x4teeth, 160mm, 6 <sup>1</sup> / <sub>4</sub> "	130-114-160
4x5teeth, 145mm, 5 <sup>3</sup> / <sub>4</sub> "	130-116-145
4x5teeth, 160mm, 6 <sup>1</sup> / <sub>4</sub> "	130-116-160



**Tissue Forceps, 1x2 teeth, delicate**

145mm, 5 <sup>3</sup> / <sub>4</sub> "	130-118-145
155mm, 6 <sup>1</sup> / <sub>8</sub> "	130-118-155
160mm, 6 <sup>1</sup> / <sub>4</sub> "	130-118-160
180mm, 7"	130-118-180



**GERALD**

**Tissue Forceps, narrow, 1.3mm step-down tip  
1x2 teeth**

Straight, 180mm, 7"	130-150-180
Straight, 230mm, 9"	130-150-230
Curved, 180mm, 7"	130-151-180
Bayonet, 195mm, 7 <sup>3</sup> / <sub>4</sub> "	130-153-195



**SEMKEN**

**Tissue Forceps**

1x2teeth, 125mm, 5"	130-145-125
1x2teeth, 150mm, 6"	130-145-150
2x3teeth, 125mm, 5"	130-147-125



**GILLIES**

**Tissue Forceps, 1x2 teeth, cross-serrated**

150mm, 6"	130-120-150
-----------	-------------





**TC Dressing Forceps**

145mm, 5 <sup>3</sup> / <sub>4</sub> "	130-518-145
160mm, 6 <sup>1</sup> / <sub>4</sub> "	130-518-160

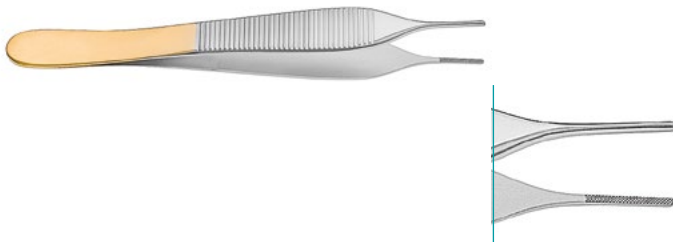

**TC MICRO ADSON Dressing Forceps, serrated**

120mm, 4 <sup>3</sup> / <sub>4</sub> "	130-538-120
--	-------------

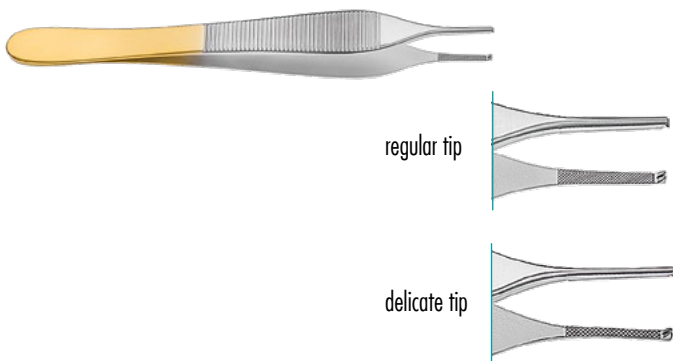

**TC ADSON Needle and Tissue Pulling Forceps, with tying platform, 1x2 teeth, cross-serrated, regular tip**

120mm 4 <sup>3</sup> / <sub>4</sub> "	130-534-120
150mm, 6"	130-534-150

regular tip

delicate tip

**delicate tip**

120mm 4 <sup>3</sup> / <sub>4</sub> "	130-537-120
150mm, 6"	130-537-150



**TC ADSON BROWN Tissue Forceps, 7x7 teeth, tying platform**

120mm, 4 <sup>3</sup> / <sub>4</sub> "	130-529-120
150mm, 6"	130-529-150



**TC ADSON Dressing Forceps, serrated**

120mm, 4 <sup>3</sup> / <sub>4</sub> "	130-532-120
150mm, 6"	130-532-150

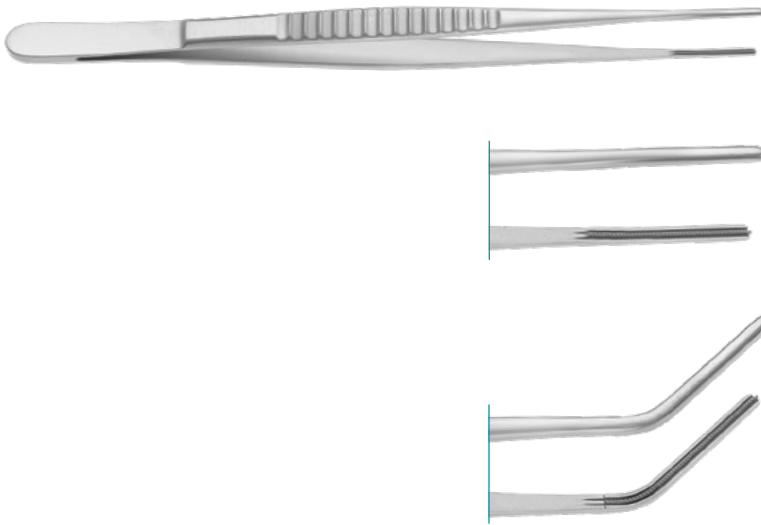

**DEBAKEY**

Vascular Atraumatic Forceps, straight,  
2.0mm tip, 24mm DeBaKEY serrations

160mm, 6 <sup>1</sup> / <sub>4</sub> "	290-552-160
200mm, 8"	290-552-200
240mm, 9 <sup>1</sup> / <sub>2</sub> "	290-552-240
300mm, 11 <sup>7</sup> / <sub>8</sub> "	290-552-300

**angled**

160mm, 6 <sup>1</sup> / <sub>4</sub> "	290-553-160
200mm, 8"	290-553-200
240mm, 9 <sup>1</sup> / <sub>2</sub> "	290-553-240
300mm, 11 <sup>7</sup> / <sub>8</sub> "	290-553-300

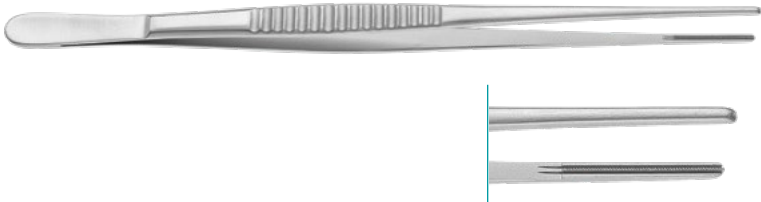

**DEBAKEY**

Vascular Atraumatic Forceps, straight,  
2.4mm tip, 24mm DeBaKEY serrations

160mm, 6 <sup>1</sup> / <sub>4</sub> "	290-557-160
200mm, 8"	290-557-200
240mm, 9 <sup>1</sup> / <sub>2</sub> "	290-557-240
300mm, 11 <sup>7</sup> / <sub>8</sub> "	290-557-300



**DEBAKEY**

Vascular Atraumatic Forceps, straight,  
3.5mm step-down tip,  
24mm DeBaKEY serrations

160mm, 6 <sup>1</sup> / <sub>4</sub> "	290-555-160
200mm, 8"	290-555-200
240mm, 9 <sup>1</sup> / <sub>2</sub> "	290-555-240
300mm, 11 <sup>7</sup> / <sub>8</sub> "	290-555-300

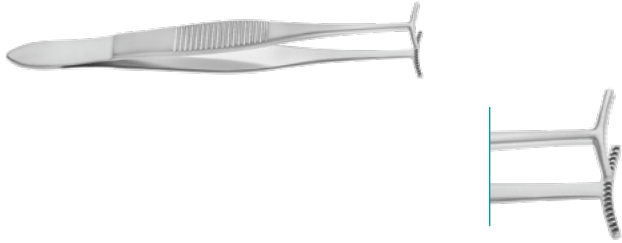

**GREEN**

Fixation Forceps, 12mm wide jaw,  
fine serrations

110mm, 4<sup>1</sup>/<sub>3</sub>"

400-029-012



**GRAEFE**

Fixation Forceps, 7x8 teeth

110mm, 4<sup>1</sup>/<sub>3</sub>"

400-025-110





# clamps and forceps.

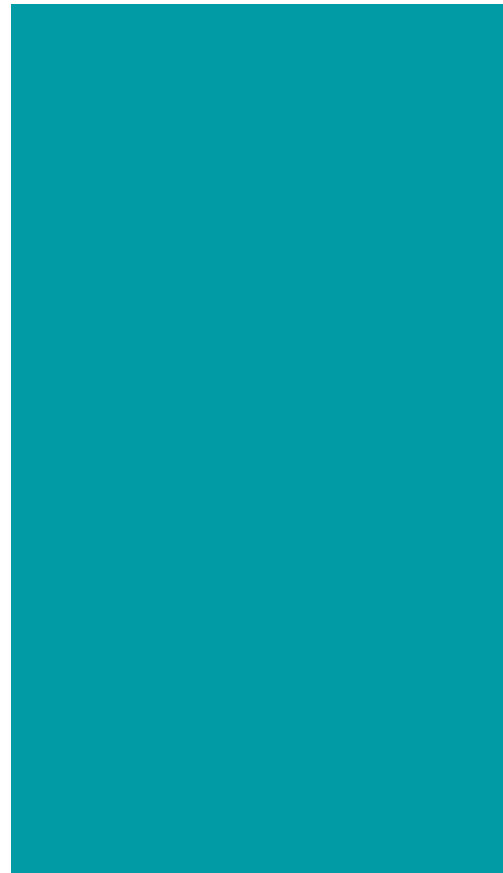



**MICRO HALSTEAD MOSQUITO**

**Hemostatic Forceps, straight**

100mm, 4"	140-270-100
120mm, 4 <sup>3</sup> / <sub>4</sub> "	140-270-120

**curved**

100mm, 4"	140-271-100
120mm, 4 <sup>3</sup> / <sub>4</sub> "	140-271-120

**straight, 1x2 teeth**

100mm, 4"	140-272-100
120mm, 4 <sup>3</sup> / <sub>4</sub> "	140-272-120

**curved, 1x2teeth**

100mm, 4"	140-273-100
120mm, 4 <sup>3</sup> / <sub>4</sub> "	140-273-120

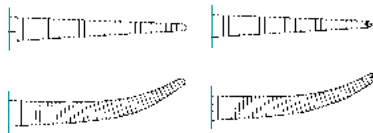
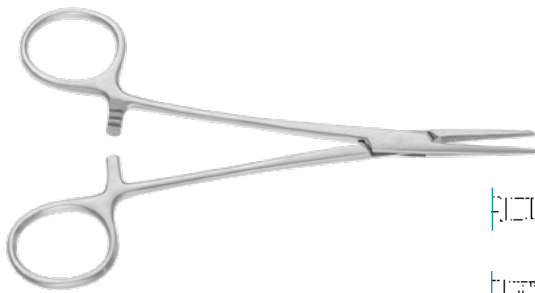

**HALSTEAD MOSQUITO**

**Hemostatic Forceps, serrated, straight**

125mm, 5"	140-254-125
140mm, 5 <sup>1</sup> / <sub>2</sub> "	140-254-140
180mm, 7"	140-254-180
210mm, 8 <sup>1</sup> / <sub>4</sub> "	140-254-210

**serrated, curved**

125mm, 5"	140-255-125
140mm, 5 <sup>1</sup> / <sub>2</sub> "	140-255-140
180mm, 7"	140-255-180
210mm, 8 <sup>1</sup> / <sub>4</sub> "	140-255-210

**1x2 teeth, curved**

125mm, 5"	140-257-125
140mm, 5 <sup>1</sup> / <sub>2</sub> "	140-257-140
180mm, 7"	140-257-180
210mm, 8 <sup>1</sup> / <sub>4</sub> "	140-257-210

**1x2 teeth, straight**

125mm, 5"	140-256-125
140mm, 5 <sup>1</sup> / <sub>2</sub> "	140-256-140
180mm, 7"	140-256-180
210mm, 8 <sup>1</sup> / <sub>4</sub> "	140-256-210

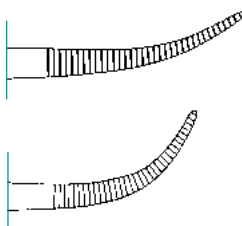

**JACOBSON**

**Hemostatic Forceps, delicate, 0.3mm tip, curved**

100mm, 4"	140-161-100
130mm, 5 <sup>1</sup> / <sub>8</sub> "	140-161-130
190mm, 7 <sup>1</sup> / <sub>2</sub> "	140-161-190

**fully curved**

130mm, 5 <sup>1</sup> / <sub>8</sub> "	140-162-130
190mm, 7 <sup>1</sup> / <sub>2</sub> "	140-162-190



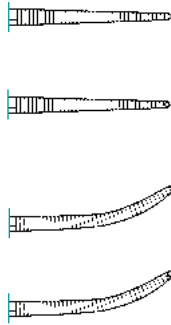

**HARTMANN MOSQUITO**

Hemostatic Forceps, serrated, straight

100mm, 4" 140-250-100

1x2 teeth, straight

100mm, 4" 140-248-100

serrated, curved

100mm, 4" 140-251-100

1x2 teeth, curved

100mm, 4" 140-249-100

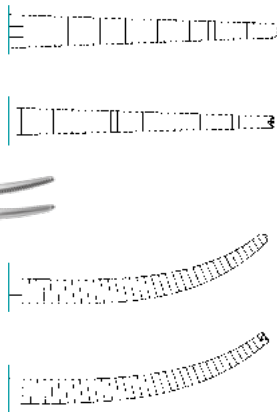

**CRILE**

Hemostatic Forceps, serrated, straight

140mm, 5 1/2" 140-290-140

1x2 teeth, straight

140mm, 5 1/2" 140-292-140

serrated, curved

140mm, 5 1/2" 140-291-140

1x2 teeth, curved

140mm, 5 1/2" 140-293-140

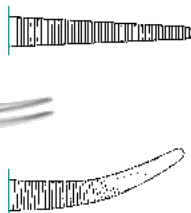

**BABY CRILE**

Hemostatic Forceps, 140mm, 5 1/2"

serrated, straight 140-334-140

serrated, curved 140-335-140

1x2 teeth, straight 140-336-140

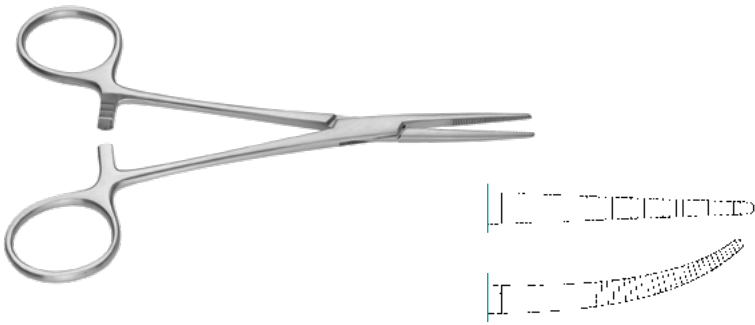
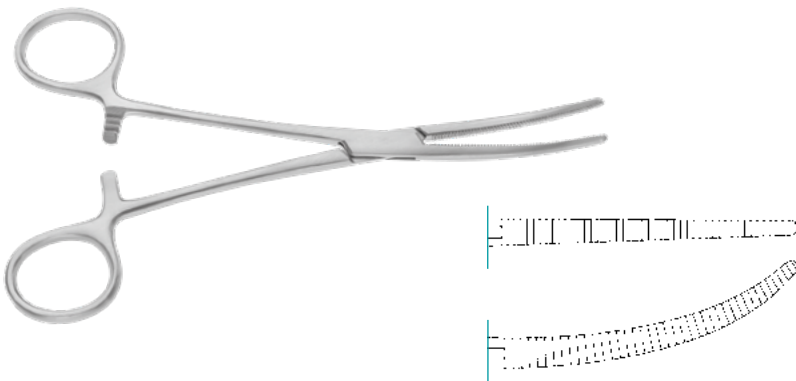
**KELLY****Hemostatic Forceps, straight**140mm, 5<sup>1</sup>/<sub>2</sub>" 140-280-140**curved**140mm, 5<sup>1</sup>/<sub>2</sub>" 140-281-140**ROCHESTER PEAN****Hemostatic Forceps, serrated, straight**140mm, 5<sup>1</sup>/<sub>2</sub>" 140-330-140160mm, 6<sup>1</sup>/<sub>4</sub>" 140-330-160

180mm, 7" 140-330-180

200mm, 8" 140-330-200

220mm, 8<sup>2</sup>/<sub>3</sub>" 140-330-220240mm, 9<sup>1</sup>/<sub>2</sub>" 140-330-240260mm, 10<sup>1</sup>/<sub>4</sub>" 140-330-260300mm, 11<sup>7</sup>/<sub>8</sub>" 140-330-300

355mm, 14" 140-330-355

**curved**140mm, 5<sup>1</sup>/<sub>2</sub>" 140-331-140160mm, 6<sup>1</sup>/<sub>4</sub>" 140-331-160

180mm, 7" 140-331-180

200mm, 8" 140-331-200

220mm, 8<sup>2</sup>/<sub>3</sub>" 140-331-220240mm, 9<sup>1</sup>/<sub>2</sub>" 140-331-240260mm, 10<sup>1</sup>/<sub>4</sub>" 140-331-260300mm, 11<sup>7</sup>/<sub>8</sub>" 140-331-300

355mm, 14" 140-331-355

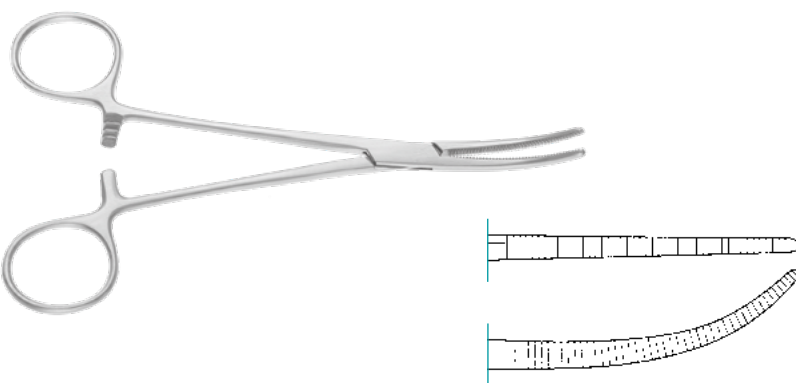
**PEAN****Hemostatic Forceps, delicate, serrated, straight**130mm, 5<sup>1</sup>/<sub>8</sub>" 140-316-130140mm, 5<sup>1</sup>/<sub>2</sub>" 140-316-140160mm, 6<sup>1</sup>/<sub>4</sub>" 140-316-160**curved**130mm, 5<sup>1</sup>/<sub>8</sub>" 140-317-130140mm, 5<sup>1</sup>/<sub>2</sub>" 140-317-140160mm, 6<sup>1</sup>/<sub>4</sub>" 140-317-160

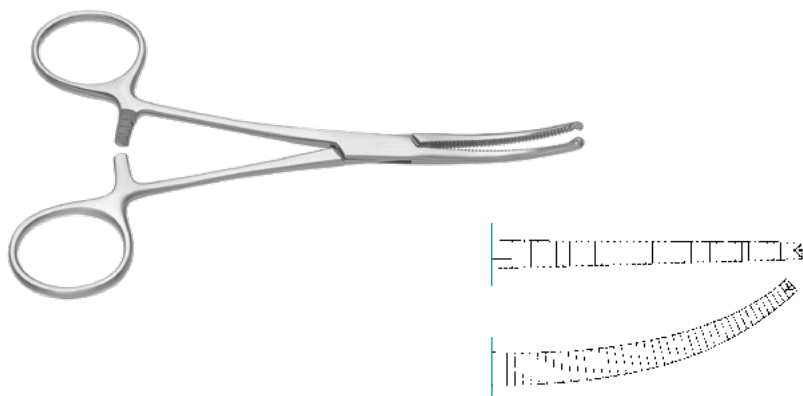

**KOCHER OCHSNER**

Hemostatic Forceps, 1x 2 teeth, straight

140mm, 5 <sup>1</sup> / <sub>2</sub> "	140-332-140
160mm, 6 <sup>1</sup> / <sub>4</sub> "	140-332-160
180mm, 7"	140-332-180
200mm, 8"	140-332-200
220mm, 8 <sup>2</sup> / <sub>3</sub> "	140-332-220
240mm, 9 <sup>1</sup> / <sub>2</sub> "	140-332-240
260mm, 10 <sup>1</sup> / <sub>4</sub> "	140-332-260
300mm, 11 <sup>7</sup> / <sub>8</sub> "	140-332-300
355mm, 14"	140-332-355

curved

140mm, 5 <sup>1</sup> / <sub>2</sub> "	140-333-140
160mm, 6 <sup>1</sup> / <sub>4</sub> "	140-333-160
180mm, 7"	140-333-180
200mm, 8"	140-333-200
220mm, 8 <sup>2</sup> / <sub>3</sub> "	140-333-220
240mm, 9 <sup>1</sup> / <sub>2</sub> "	140-333-240
260mm, 10 <sup>1</sup> / <sub>4</sub> "	140-333-260
300mm, 11 <sup>7</sup> / <sub>8</sub> "	140-333-300
355mm, 14"	140-333-355

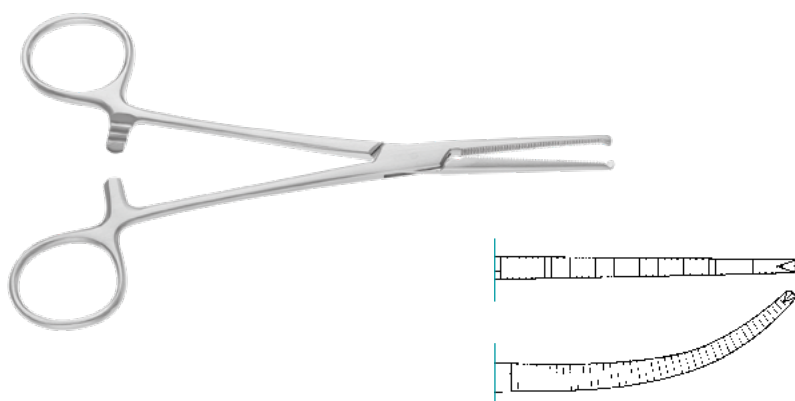

**KOCHER**

Delicate Hemostatic Forceps, 1x2 teeth, straight

130mm, 5 <sup>1</sup> / <sub>8</sub> "	140-318-130
140mm, 5 <sup>1</sup> / <sub>2</sub> "	140-318-140
160mm, 6 <sup>1</sup> / <sub>4</sub> "	140-318-160

curved

130mm, 5 <sup>1</sup> / <sub>8</sub> "	140-319-130
140mm, 5 <sup>1</sup> / <sub>2</sub> "	140-319-140
160mm, 6 <sup>1</sup> / <sub>4</sub> "	140-319-160



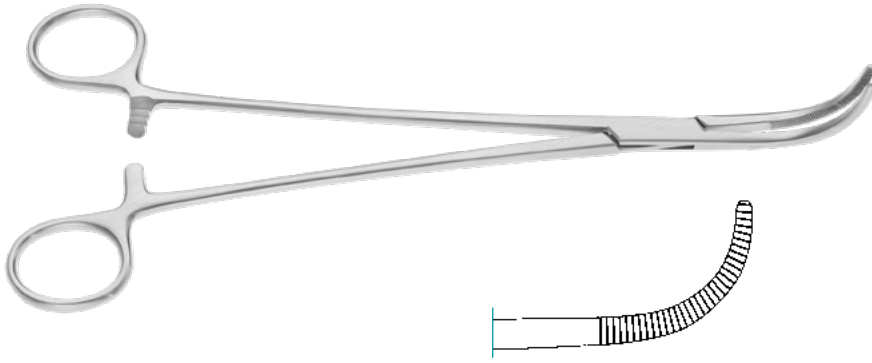

**MIXTER**  
Dissecting and Ligature Forceps,  
partially serrated

220mm, 8 <sup>2</sup> / <sub>3</sub> "	140-427-220
230mm, 9"	140-429-230

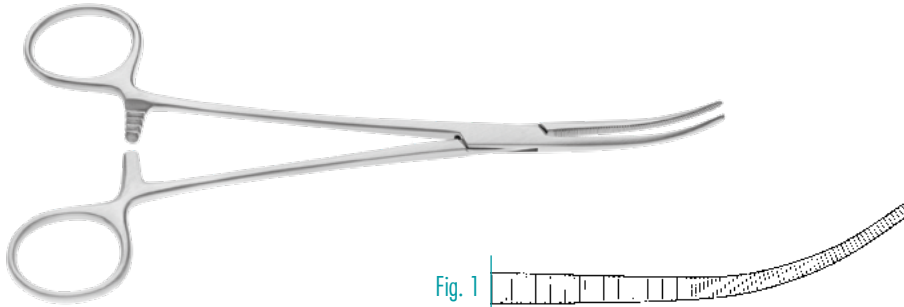

**KELLY**  
Dissecting Forceps, fully serrated,  
Fig. 1

190mm, 7 <sup>1</sup> / <sub>2</sub> "	140-633-190
220mm, 8 <sup>2</sup> / <sub>3</sub> "	140-633-220
240mm, 9 <sup>1</sup> / <sub>2</sub> "	140-633-240



**Fig. 2**

190mm, 7 <sup>1</sup> / <sub>2</sub> "	140-635-190
220mm, 8 <sup>2</sup> / <sub>3</sub> "	140-635-220
240mm, 9 <sup>1</sup> / <sub>2</sub> "	140-635-240

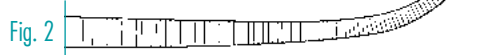

**Fig. 3**

190mm, 7 <sup>1</sup> / <sub>2</sub> "	140-637-190
220mm, 8 <sup>2</sup> / <sub>3</sub> "	140-637-220
240mm, 9 <sup>1</sup> / <sub>2</sub> "	140-637-240

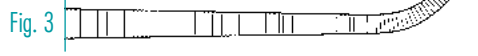

**BABY MIXTER**  
Dissecting and Ligature Forceps,  
serrated, curved

140mm, 5 <sup>1</sup> / <sub>2</sub> "	140-421-140
--	-------------

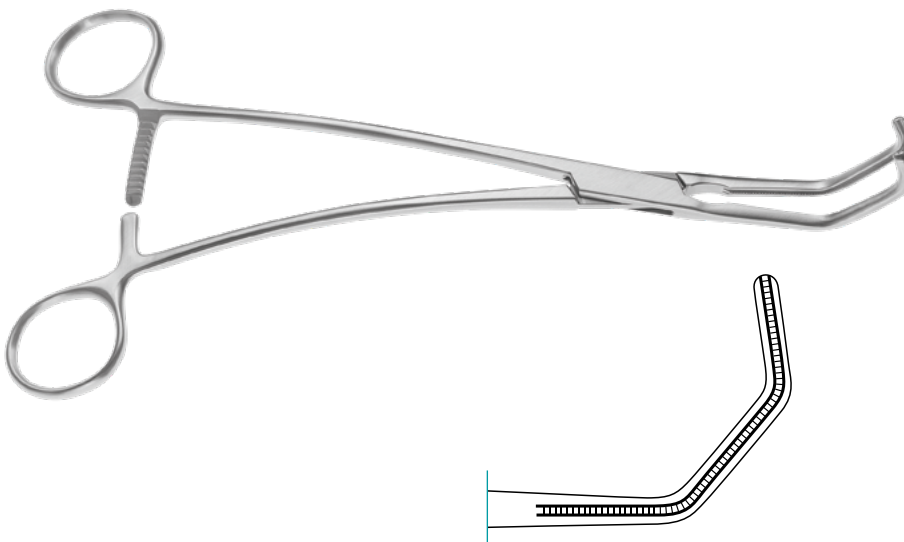

**SATINSKY**  
Tangential Clamp

200mm, 8"	290-425-200
-----------	-------------

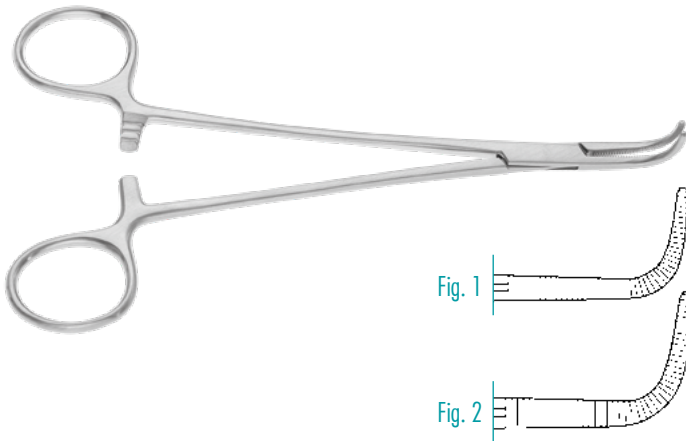

**MEEKER**

Kidney Pedicle Clamp, curved,  
Fig. 1

180mm, 7" 140-619-180

Fig. 2

280mm, 11" 140-619-275

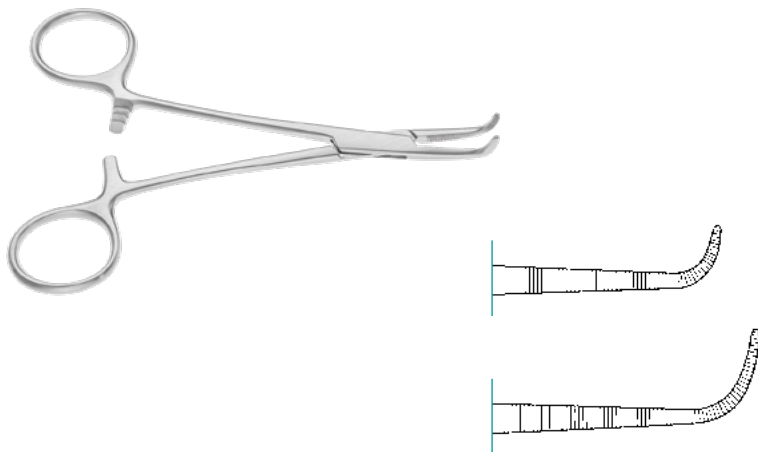

**MINI GEMINI**

Dissecting Forceps, fully serrated, curved

130mm, 5<sup>1</sup>/<sub>8</sub>" 140-359-130

160mm, 6<sup>1</sup>/<sub>4</sub>" 140-359-160

180mm, 7" 140-359-180

200mm, 8" 140-359-200

220mm, 8<sup>2</sup>/<sub>3</sub>" 140-359-220

230mm, 9" 140-359-230

250mm, 9<sup>7</sup>/<sub>8</sub>" 140-359-250

280mm, 11" 140-359-280

**GEMINI**

Dissecting Forceps, fully serrated, curved

130mm, 5<sup>1</sup>/<sub>8</sub>" 140-361-130

160mm, 6<sup>1</sup>/<sub>4</sub>" 140-361-160

180mm, 7" 140-361-180

200mm, 8" 140-361-200

220mm, 8<sup>2</sup>/<sub>3</sub>" 140-361-220

230mm, 9" 140-361-230

250mm, 9<sup>7</sup>/<sub>8</sub>" 140-361-250

280mm, 11" 140-361-280

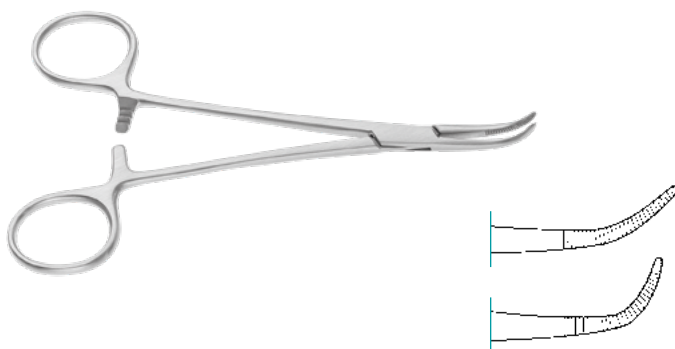

**BABY MIXTER**

Artery Forceps, slightly curved

140mm, 5<sup>1</sup>/<sub>2</sub>" 140-244-140

strongly curved

140mm, 5<sup>1</sup>/<sub>2</sub>" 140-245-140

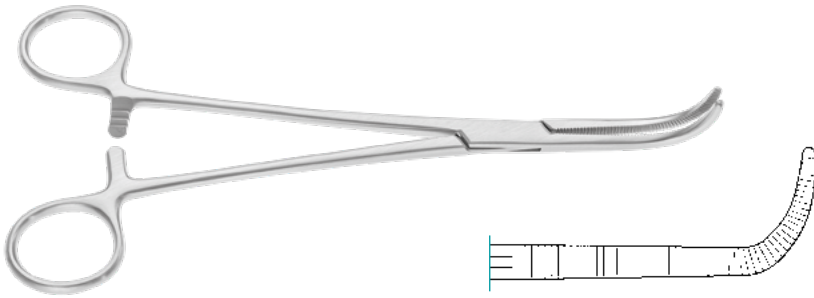

**MIXTER**  
Forceps, fully serrated

155mm, 6 <sup>1/8</sup> "	140-423-155
190mm, 7 <sup>1/2</sup> "	140-423-190

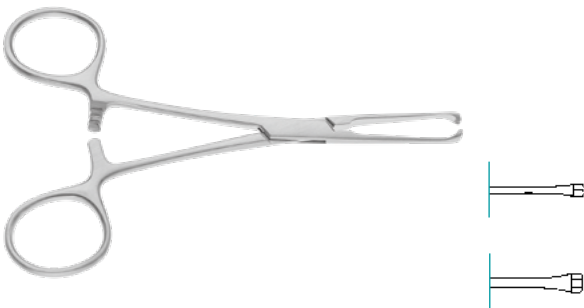

**PETIT ALLIS**  
Tissue Forceps, 2x3 teeth

120mm, 4 <sup>3/4</sup> "	310-008-120
150mm, 6"	310-008-150

**3x4 teeth**

120mm, 4 <sup>3/4</sup> "	310-009-120
150mm, 6"	310-009-150



**ALLIS**  
Tissue Forceps, 7mm wide, 5x6 teeth

150mm, 6"	310-014-150
190mm, 7 <sup>1/2</sup> "	310-014-190
220mm, 8 <sup>2/3</sup> "	310-014-220
250mm, 9 <sup>7/8</sup> "	310-014-250



**JUDD ALLIS**  
Tissue Forceps, 3x4 teeth, 4mm wide

150mm, 6"	310-028-150
-----------	-------------

**4.3mm wide**

190mm, 7 <sup>1/2</sup> "	310-026-190
---------------------------	-------------



**ALLIS ADAIR**

Tissue Forceps, 9x10 teeth, 10mm wide

155mm, 6<sup>1</sup>/<sub>8</sub>" 310-027-155



**BABCOCK**

Tissue Forceps, 8mm wide

160mm, 6<sup>1</sup>/<sub>4</sub>" 310-110-160

10.5mm wide

180mm, 7" 310-110-180

11mm wide

200mm, 8" 310-110-200

11.8mm wide

240mm, 9<sup>1</sup>/<sub>2</sub>" 310-110-240

11.5mm wide

300mm, 11<sup>7</sup>/<sub>8</sub>" 310-110-300

12mm wide

355mm, 14" 310-110-355

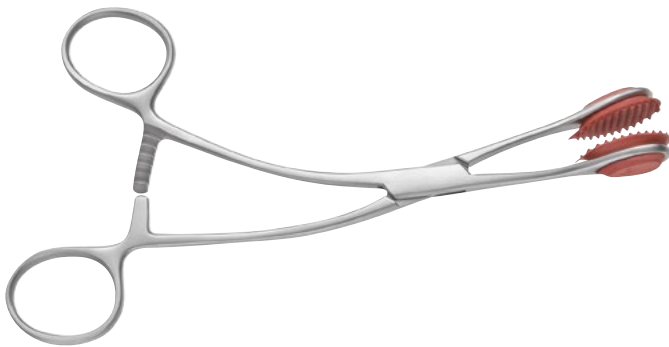

**YOUNG**

Tongue Holding Forceps

170mm, 6<sup>2</sup>/<sub>3</sub>" 430-467-170



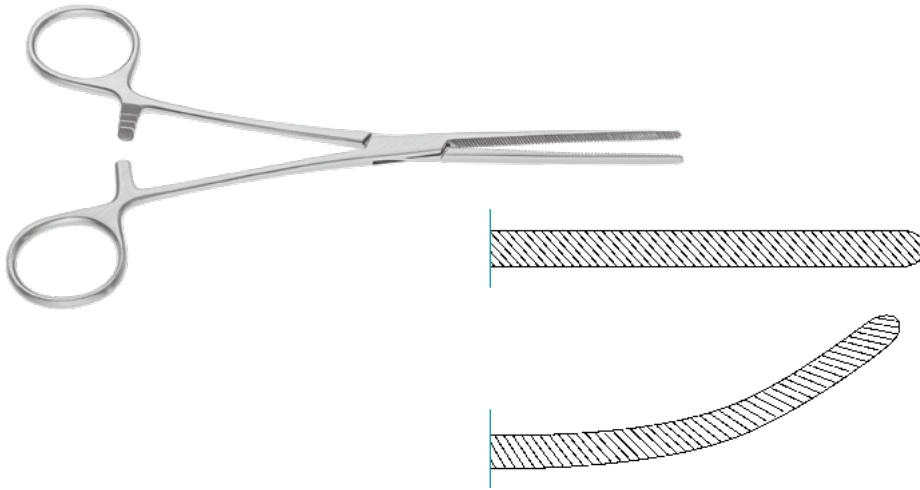

**BABY DOYEN**

Intestinal Clamp, diagonal serrations, elastic  
180mm, 7"

straight	310-290-180
curved	310-291-180

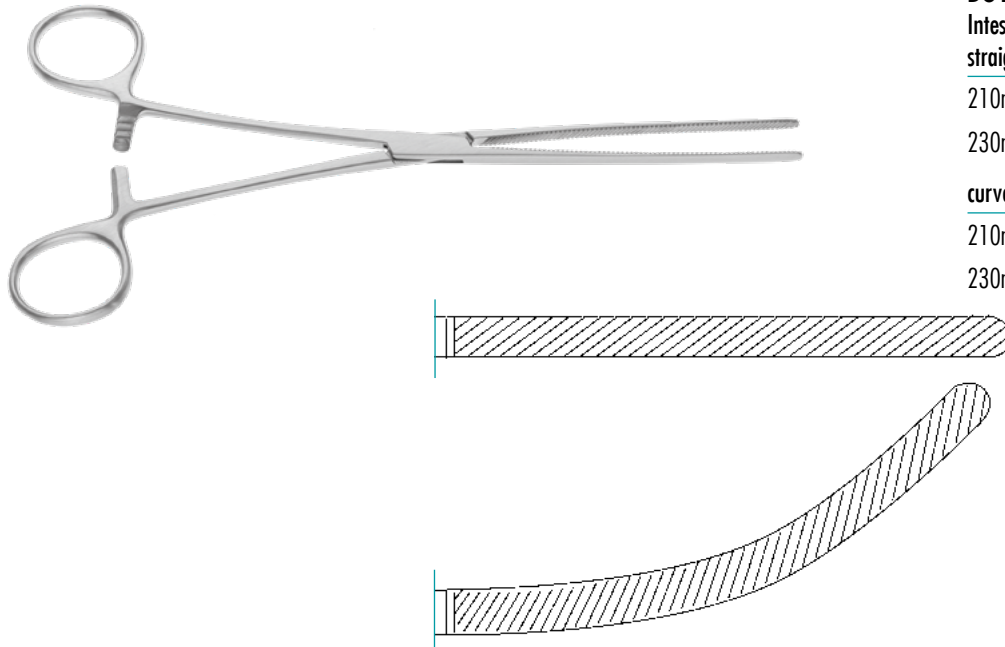

**DOYEN**

Intestinal Clamp, diagonal serrations, elastic,  
straight

210mm, 8 <sup>1</sup> / <sub>4</sub> "	310-290-210
230mm, 9"	310-290-230

**curved**

210mm, 8 <sup>1</sup> / <sub>4</sub> "	310-291-210
230mm, 9"	310-291-230

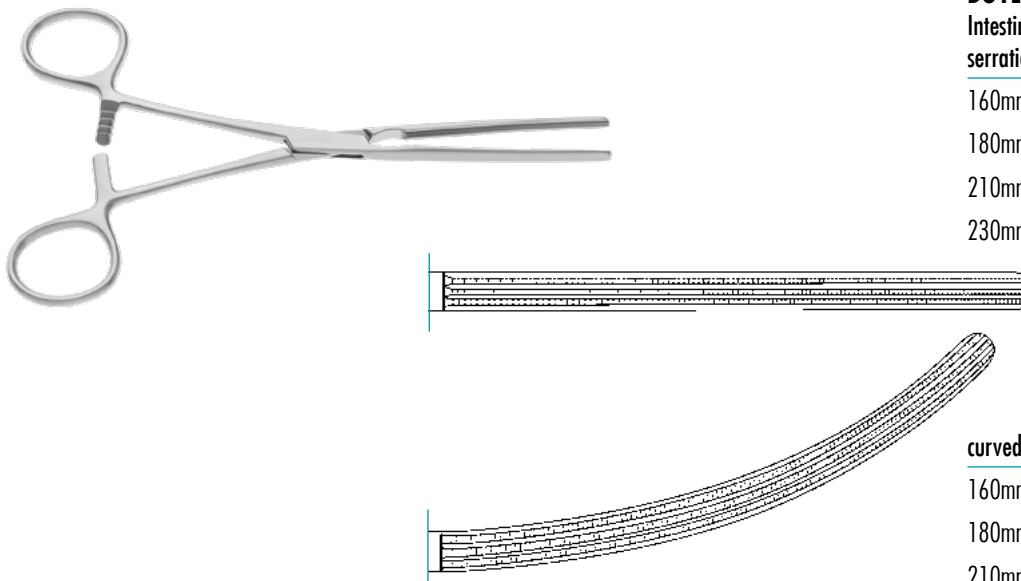

**DOYEN ATRAUMATIC**

Intestinal Clamp, atraumatic elastic  
serrations, straight

160mm, 6 <sup>1</sup> / <sub>4</sub> "	310-550-160
180mm, 7"	310-550-180
210mm, 8 <sup>1</sup> / <sub>4</sub> "	310-550-210
230mm, 9"	310-550-230

**curved**

160mm, 6 <sup>1</sup> / <sub>4</sub> "	310-551-160
180mm, 7"	310-551-180
210mm, 8 <sup>1</sup> / <sub>4</sub> "	310-551-210
230mm, 9"	310-551-230





**BACKHAUS**  
Towel Forceps

90mm, 3 <sup>1</sup> / <sub>2</sub> "	140-573-090
110mm, 4 <sup>1</sup> / <sub>3</sub> "	140-573-110
130mm, 5 <sup>1</sup> / <sub>8</sub> "	140-573-130
150mm, 6"	140-573-150



**Ball & Socket Towel Forceps**

110mm, 4 <sup>1</sup> / <sub>3</sub> "	140-580-115
130mm, 5 <sup>1</sup> / <sub>8</sub> "	140-580-130



**PEERS**  
Towel Forceps, non-perforating

145mm, 5 <sup>3</sup> / <sub>4</sub> "	140-595-145
--	-------------

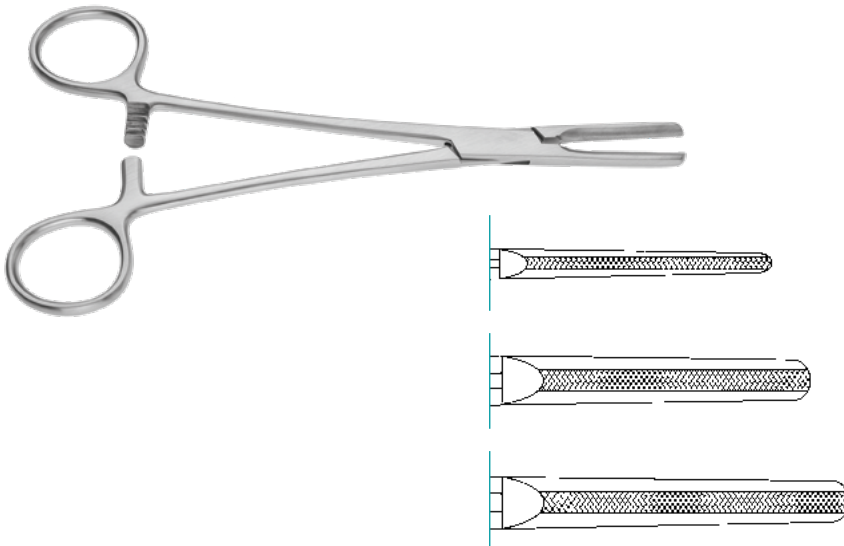

**VORSE**

**Tubing Clamp, serrated jaws**

150mm, 6"	140-603-150
180mm, 7"	140-603-180
200mm, 8"	140-603-200

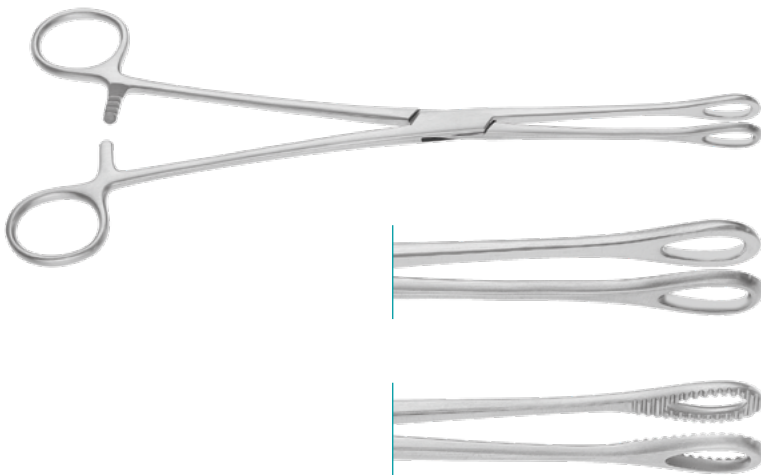

**FOERSTER**

**Sponge Forceps, smooth, straight**

180mm, 7"	150-050-180
200mm, 8"	150-050-200
250mm, 9 <sup>7</sup> / <sub>8</sub> "	150-050-250

**smooth, curved**

180mm, 7"	150-053-180
200mm, 8"	150-053-200
250mm, 9 <sup>7</sup> / <sub>8</sub> "	150-053-250

**serrated, straight**

180mm, 7"	150-052-180
200mm, 8"	150-052-200
250mm, 9 <sup>7</sup> / <sub>8</sub> "	150-052-250
355mm, 14"	150-052-355
410mm, 16"	150-052-410

**serrated, curved**

180mm, 7"	150-055-180
200mm, 8"	150-055-200
250mm, 9 <sup>7</sup> / <sub>8</sub> "	150-055-250

# needle holders.

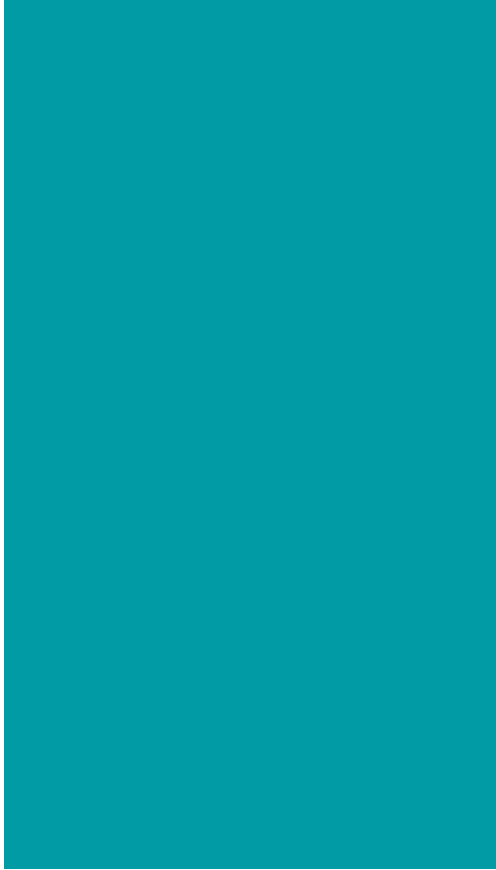



### Needle Holders *without* Tungsten Carbide inserts



Standard serration for an optimal grip of the needle.

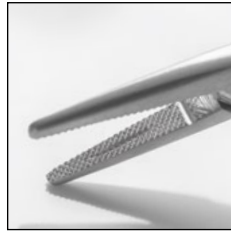

Standard serration with additional groove



Standard Ring Handle

### Needle Holders *with* Tungsten Carbide inserts



Normal serration of 0.5 for use with sutures up to size 4-0

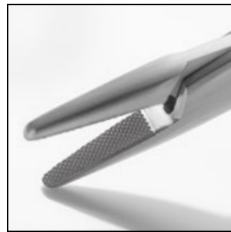

Fine serration of 0.4 for use with sutures up to size 5-0 / 6-0

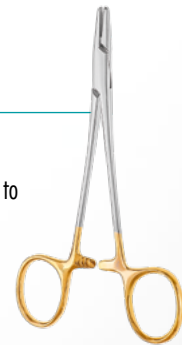

Mirror gold finished ring handle



Extra fine serration of 0.3 for use with sutures up to size 10-0



Smooth serration for use with sutures up to size 7-0 to 10-0

### Needle Holders with Diamond Dusted jaw



Diamond dusted coating of the jaw hardens the working surface, improves the durability and guarantees a tight grip of fine needles



Mirror finished ring handle





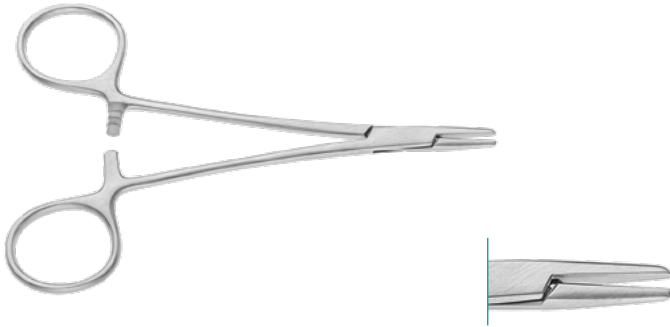

**WEBSTER**  
Straight, smooth

130mm, 5<sup>1</sup>/<sub>8</sub>"

180-318-130



**CONVERSE**  
Longitudinal serrated jaw, straight

125mm, 5"

180-310-125



**DERF**  
Grooved serrated jaw, straight

120mm, 4<sup>3</sup>/<sub>4</sub>"

180-310-120

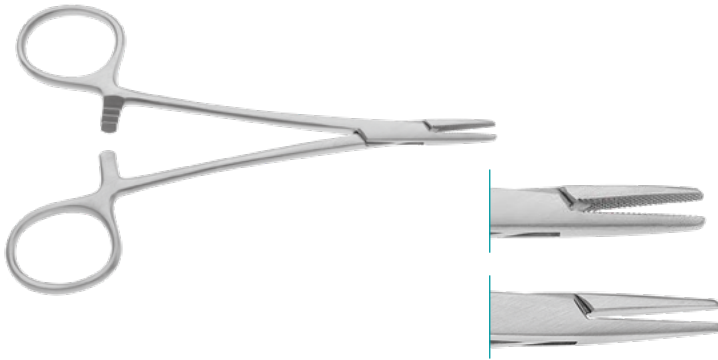

**HALSEY**

Cross serrated jaw, straight

130mm, 5<sup>1</sup>/<sub>8</sub>" 180-321-130

Smooth

130mm, 5<sup>1</sup>/<sub>8</sub>" 180-320-130



**CRILE MURRAY**

Serrated jaw, straight

150mm, 6" 180-330-150

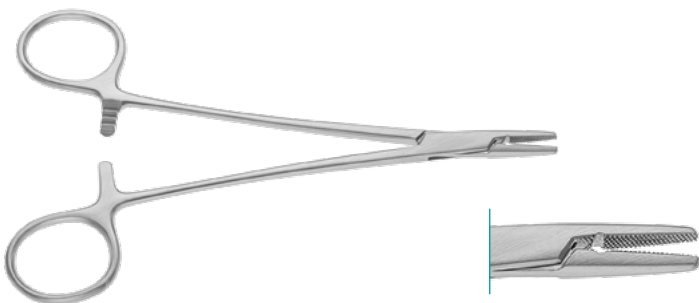

**CRILE WOOD**

Serrated jaw, straight

150mm, 6" 180-332-150

180mm, 7" 180-332-180

200mm, 8" 180-332-200

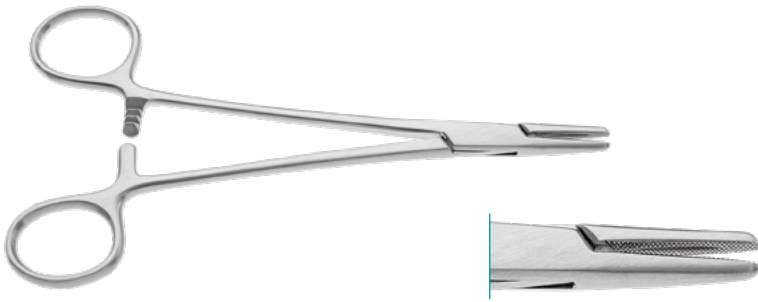
**MAYO HEGAR**

Grooved serrated jaw, straight

140mm, 5 <sup>1</sup> / <sub>2</sub> "	180-354-140
160mm, 6 <sup>1</sup> / <sub>4</sub> "	180-354-160
180mm, 7"	180-354-180
200mm, 8"	180-354-200
240mm, 9 <sup>1</sup> / <sub>2</sub> "	180-354-240
260mm, 10 <sup>1</sup> / <sub>4</sub> "	180-354-260
300mm, 11 <sup>7</sup> / <sub>8</sub> "	180-354-300

**MAYO HEGAR FINO**

Delicate Pattern, serrated, straight

140mm, 5 <sup>1</sup> / <sub>2</sub> "	180-356-140
160mm, 6 <sup>1</sup> / <sub>4</sub> "	180-356-160
180mm, 7"	180-356-180
200mm, 8"	180-356-200

**OLSEN HEGAR**

Serrated jaw, straight

140mm, 5 <sup>1</sup> / <sub>2</sub> "	180-382-140
170mm, 6 <sup>2</sup> / <sub>3</sub> "	180-382-170
180mm, 7"	180-382-180

**MATHIEU**

Serrated jaw, straight

140mm, 5 <sup>1</sup> / <sub>2</sub> "	180-420-140
170mm, 6 <sup>2</sup> / <sub>3</sub> "	180-420-170
200mm, 8"	180-420-200



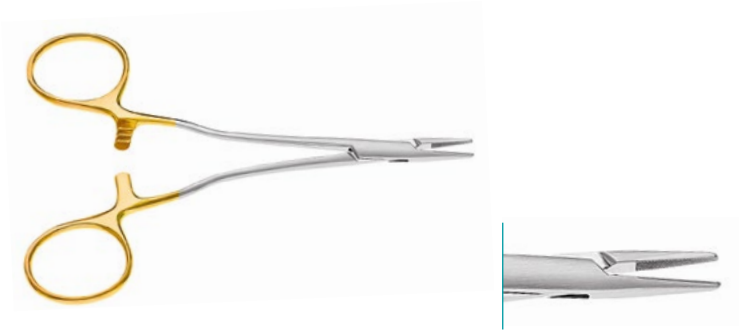

**CONVERSE**

Cross-serrated jaw, straight

120mm, 4<sup>3</sup>/<sub>4</sub>" 180-544-120

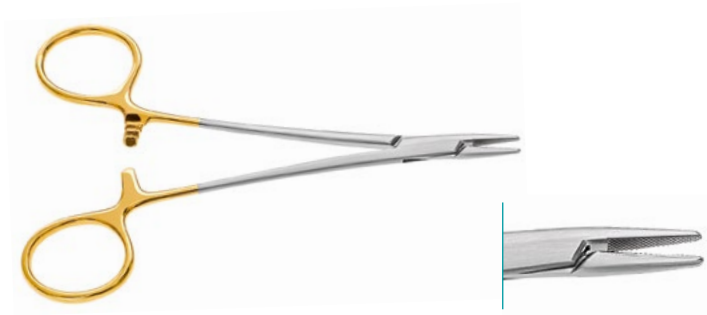

**DERF**

Serrated jaw, straight

120mm, 4<sup>3</sup>/<sub>4</sub>" 180-532-120

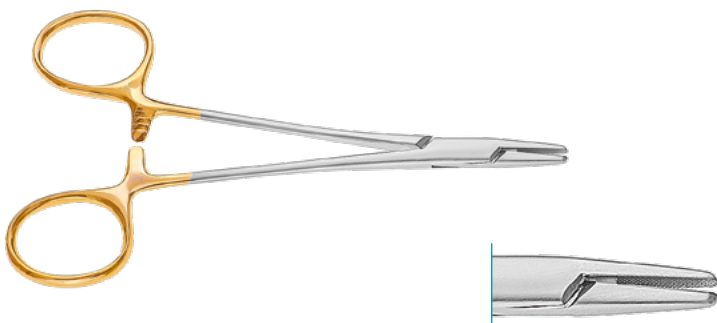

**HEGAR BAUMGARTNER**

Serrated jaw, straight

125mm, 5" 180-534-125

140mm, 5<sup>1</sup>/<sub>2</sub>" 180-534-140

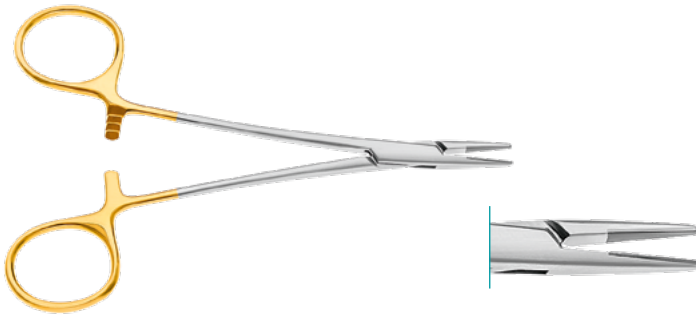

**WEBSTER**

Smooth jaw, delicate pattern, straight

130mm, 5<sup>1</sup>/<sub>8</sub>" 180-538-130

serrated jaw

130mm, 5<sup>1</sup>/<sub>8</sub>" 180-539-130



**HALSEY**

Serrated jaw, straight

130mm, 5<sup>1</sup>/<sub>8</sub>" 180-537-130

smooth jaw

130mm, 5<sup>1</sup>/<sub>8</sub>" 180-536-130



**BABY CRILE WOOD**

Serrated jaw, straight

150mm, 6" 180-542-150

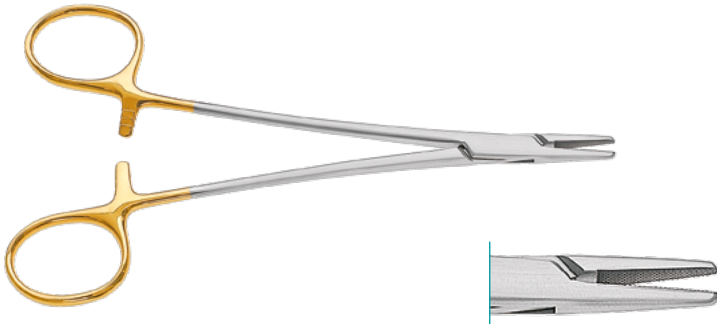

**CRILE WOOD**

Serrated jaw, straight

150mm, 6"	180-540-150
180mm, 7"	180-540-180
200mm, 8"	180-540-200
230mm, 9"	180-540-230
260mm, 10 <sup>1</sup> / <sub>4</sub> "	180-540-260
300mm, 11 <sup>7</sup> / <sub>8</sub> "	180-540-300



**CRILE WOOD**

Smooth jaw, straight

150mm, 6"	180-541-150
180mm, 7"	180-541-180
200mm, 8"	180-541-200
230mm, 9"	180-541-230

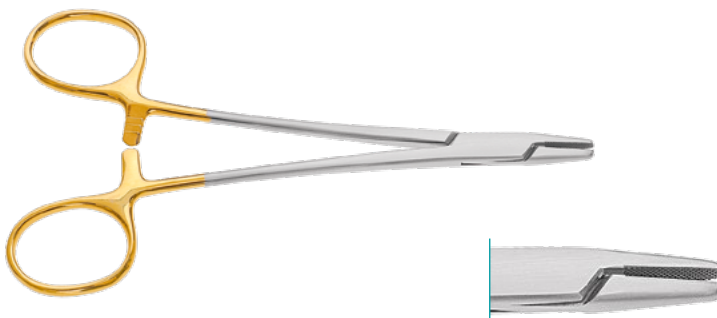

**MAYO HEGAR**

Serrated jaw, straight

125mm, 5"	180-550-125
140mm, 5 <sup>1</sup> / <sub>2</sub> "	180-550-140
160mm, 6 <sup>1</sup> / <sub>4</sub> "	180-550-160
180mm, 7"	180-550-180
200mm, 8"	180-550-200
240mm, 9 <sup>1</sup> / <sub>2</sub> "	180-550-240
260mm, 10 <sup>1</sup> / <sub>4</sub> "	180-550-260
300mm, 11 <sup>7</sup> / <sub>8</sub> "	180-550-300
355mm, 14"	180-550-355
400mm, 15 <sup>3</sup> / <sub>4</sub> "	180-550-400

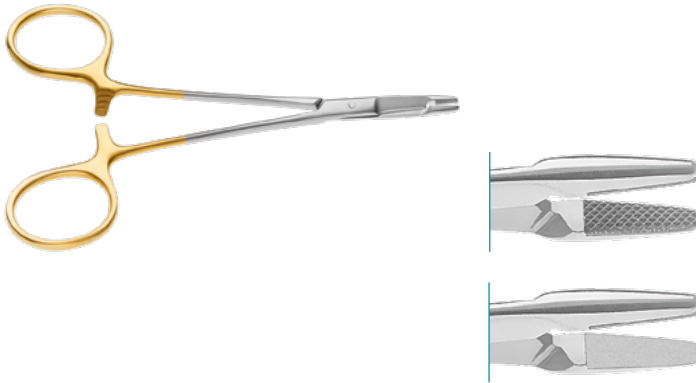

**MINI OLSEN HEGAR**

Serrated jaw, straight

120mm, 4<sup>3/4</sup>" 180-568-120

smooth jaw

120mm, 4<sup>3/2</sup>" 180-569-120



**OLSEN HEGAR**

Serrated jaw, straight

140mm, 5<sup>1/2</sup>" 180-568-140

170mm, 6<sup>2/3</sup>" 180-568-170

180mm, 7" 180-568-180

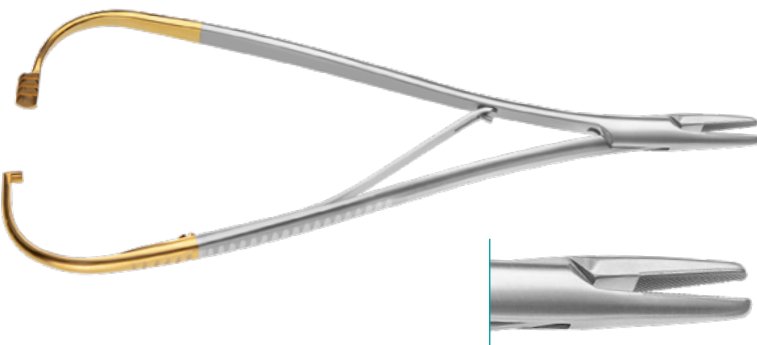

**MATHIEU**

Serrated jaw, straight

140mm, 5<sup>1/2</sup>" 180-576-140

170mm, 6<sup>2/3</sup>" 180-576-170

200mm, 8" 180-576-200

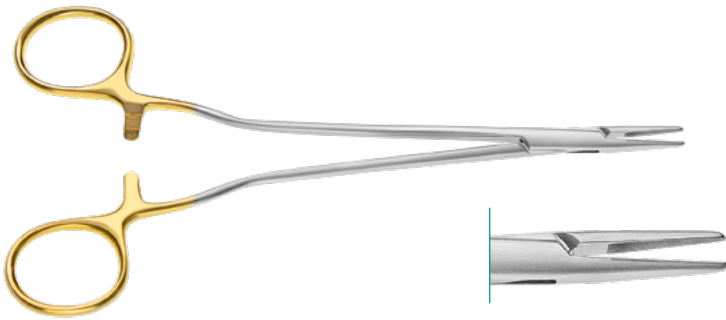

**HEGAR**

Vascular, micro profile, straight

140mm, 5 <sup>1</sup> / <sub>2</sub> "	180-590-140
180mm, 7"	180-590-180
200mm, 8"	180-590-200
230mm, 9"	180-590-230

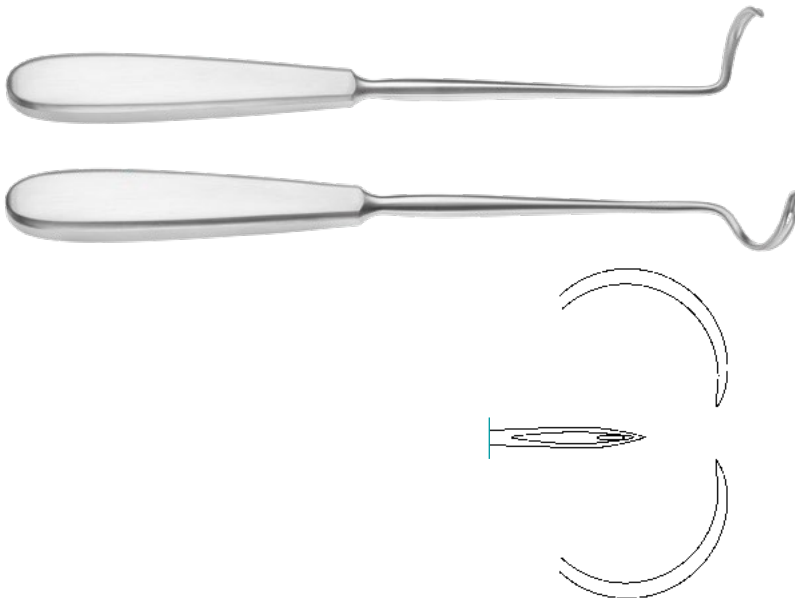

**DESCHAMPS**

Ligature Needles, sharp

left curved, for right hand	180-724-200
right curved, for left hand	180-728-200

**blunt**

left curved, for right hand	180-726-210
right curved, for left hand	180-727-210





# retractors.





**GRAEFFE**

Micro Skin Hook, 125mm, 5"

sharp	170-010-125
blunt	170-011-125



**KILNER**

Skin Hook, sharp

150mm, 6"	230-203-150
-----------	-------------

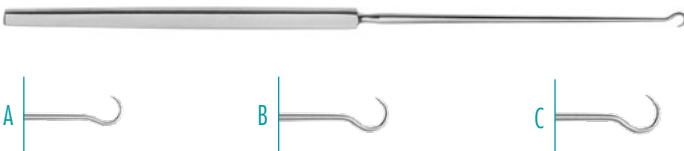

**GILLIES**

Skin Hook, 180mm, 7"

A Small	230-205-180
B Medium	230-207-180
C Large	230-209-180



**JOSEPH**

Skin Hook

160mm, 6 <sup>1</sup> / <sub>4</sub> "	170-014-001
--	-------------





Cat Castration Hook

170-015-171

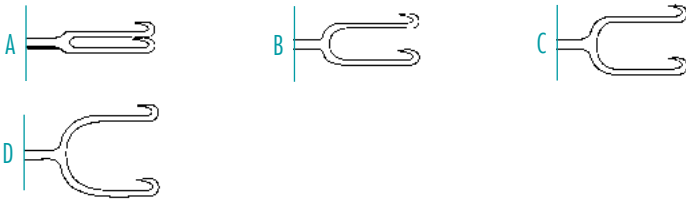

**JOSEPH**

Skin Hook, 2 prongs, 160mm, 6<sup>1</sup>/<sub>4</sub>"

A	2mm wide	170-014-002
B	5mm wide	170-014-005
C	7mm wide	170-014-007
D	10mm wide	170-014-010

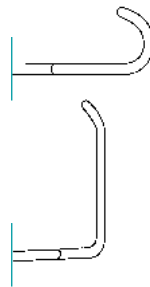

**BABY SENN-MILLER**

Hand Held Retractor,  
8 x 7mm / 20 x 7mm, 155mm, 6<sup>1</sup>/<sub>8</sub>"

sharp	170-214-160
blunt	170-213-160

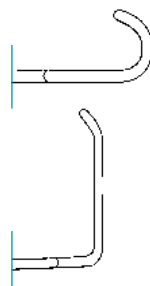

**SENN MILLER**

Hand Held Retractor,  
8 x 7mm / 18 x 5.5mm, 160mm, 6<sup>1</sup>/<sub>4</sub>"

sharp	170-210-160
blunt	170-212-160

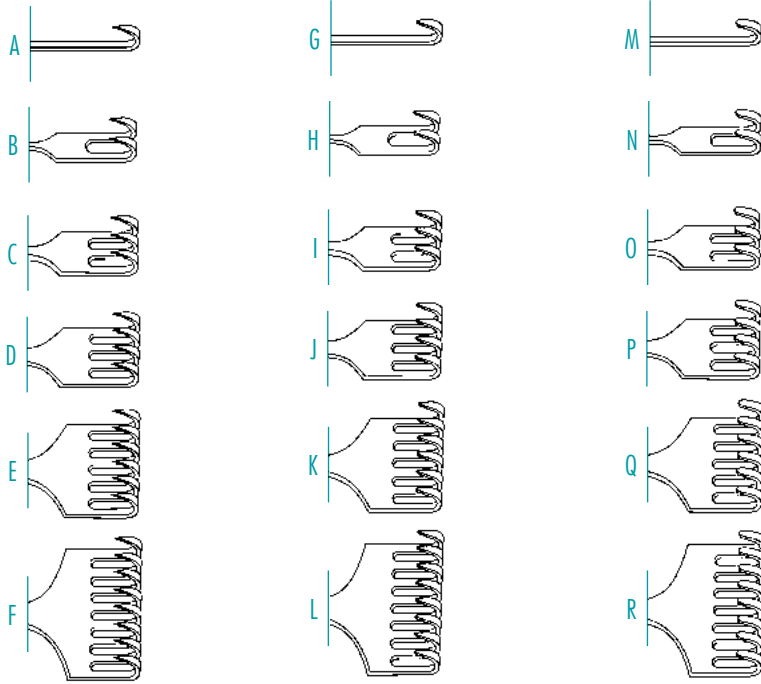

**VOLKMANN**

Retractor, 215mm, 8<sup>1/2</sup>"  
sharp

A	1 prong, 9mm	170-220-215
B	2 prongs, 9x8mm	170-222-215
C	3 prongs, 9x13mm	170-224-215
D	4 prongs, 9x19mm	170-226-215
E	6 prongs, 9x29mm	170-228-215
F	8 prongs, 9x40mm	170-230-215

**semi - sharp**

G	1 prong, 9mm	170-231-215
H	2 prongs, 9x8mm	170-233-215
I	3 prongs, 9x13mm	170-235-215
J	4 prongs, 9x19mm	170-237-215
K	6 prongs, 9x29mm	170-239-215
L	8 prongs, 9x40mm	170-241-215

**blunt**

M	1 prong, 9mm	170-221-215
N	2 prongs, 9x8mm	170-223-215
O	3 prongs, 9x13mm	170-225-215
P	4 prongs, 9x19mm	170-227-215
Q	6 prongs, 9x29mm	170-229-215
R	8 prongs, 9x40mm	170-231-215





**KOCHER LANGENBECK**

Retractor, 215mm, 8<sup>1</sup>/<sub>2</sub>"

22 x 6mm	170-317-022
25 x 8mm	170-317-025
25 x 6mm	170-317-026
35 x 8mm	170-317-035
35 x 11mm	170-317-036
35 x 15mm	170-317-037
40 x 11mm	170-317-040
55 x 11mm	170-317-055
70 x 15mm	170-317-070
80 x 12mm	170-317-080
80 x 15mm	170-317-081

**RIBBON**

Abdominal Retractor, malleable

200 x 6mm	170-973-006
200 x 12mm	170-973-012
200 x 17mm	170-973-017
200 x 20mm	170-973-020
250 x 25mm	170-973-025
330 x 10mm	170-963-010
330 x 13mm	170-963-013
330 x 19mm	170-963-019
330 x 25mm	170-963-025
330 x 32mm	170-963-032
330 x 40mm	170-963-040
330 x 50mm	170-963-050
330 x 68mm	170-963-068

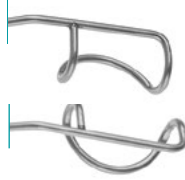

**BARRAQUER**

**Eye Specula**

Children, 10mm blade 400-500-030

Adult, 40mm blade 400-500-040

**1mm wire thickness**

Adult, 40mm blade 400-500-045



**FINSEN**

**Spring Retractor, 2x3 teeth, 50mm, 2"**

sharp 170-700-050

blunt 170-701-050

**3x4 teeth, 70mm, 2<sup>3</sup>/<sub>4</sub>"**

sharp 170-702-070

blunt 170-703-070

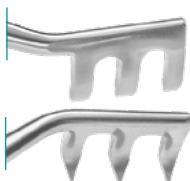

**JANSEN**

**3x3 prongs, 100mm, 4"**

sharp 170-720-100

blunt 170-723-100



**BABY WEITLANER**

2x3 teeth, 105mm, 4<sup>1</sup>/<sub>8</sub>"

sharp 170-748-105

115mm, 4<sup>1</sup>/<sub>2</sub>"

blunt 170-749-105

semi-sharp 170-750-105



**WULLSTEIN**

3x4 teeth, curved arms, 105mm, 4<sup>1</sup>/<sub>8</sub>"

sharp 170-742-105

blunt 170-743-105

130mm, 5<sup>1</sup>/<sub>8</sub>"

sharp 170-742-130

blunt 170-743-130

150mm, 6"

sharp 170-742-150

blunt 170-743-130

180mm, 7"

sharp 170-742-180

blunt 170-743-180



**WEITLANER**

3x4 teeth, sharp

130mm, 5<sup>1</sup>/<sub>8</sub>" 170-750-130

165mm, 6<sup>1</sup>/<sub>2</sub>" 170-750-165

200mm, 8" 170-750-200

240mm, 9<sup>1</sup>/<sub>2</sub>" 170-750-240

**blunt**

130mm, 5<sup>1</sup>/<sub>8</sub>" 170-751-130

165mm, 6<sup>1</sup>/<sub>2</sub>" 170-751-165

200mm, 8" 170-751-200

240mm, 9<sup>1</sup>/<sub>2</sub>" 170-751-240



**ADSON**

4x4 teeth, straight arms, 200mm, 8"

blunt 170-730-200

sharp 170-731-200



**MEYERDING**

Laminectomy Retractor, 200mm, 8"

25x32mm blade 170-791-001

25x54mm blade 170-791-002

19x60mm blade 170-791-003

25x60mm blade 170-791-004





<b>GELPI</b> Perineal Retractor, pediatric size	
90mm, 3 <sup>1</sup> / <sub>2</sub> "	170-802-090
110mm, 4 <sup>1</sup> / <sub>3</sub> "	170-802-110
135mm, 5 <sup>1</sup> / <sub>3</sub> "	170-802-135



<b>GELPI</b> Perineal Retractor	
180mm, 7"	170-802-180
with ball stops	
190mm, 7 <sup>1</sup> / <sub>2</sub> "	170-803-180

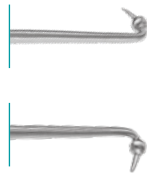

<b>DEBAKEY</b> sharp	
100mm, 4"	170-745-100
170mm, 6 <sup>2</sup> / <sub>3</sub> "	170-745-170

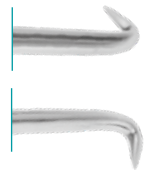

<b>JOHNSON</b> Neuroma Retractor, 90° angled, 7.5mm tip	
85mm, 3 <sup>1</sup> / <sub>4</sub> "	170-801-085
100mm, 4"	170-801-100

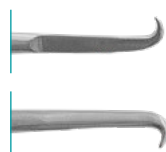



**FINOCHIETTO BABY**

Rib Spreader, straight arms

51 x 15 x 13mm (length/width/depth)

55mm spread 290-177-055

51 x 15 x 13mm (length/width/depth)

75mm spread 290-177-070

60 x 21 x 18mm (length/width/depth)

80mm spread 290-177-075

curved arms

60 x 21 x 18mm (length/width/depth)

80mm spread 290-179-075

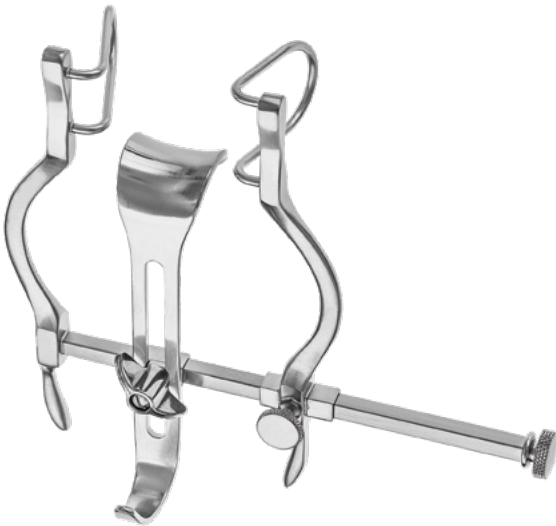

**BALFOUR BABY**

Abdominal Retractor

95mm wide, 2 lateral blades: 38mm

center blade: 23 x 25mm

170-766-090

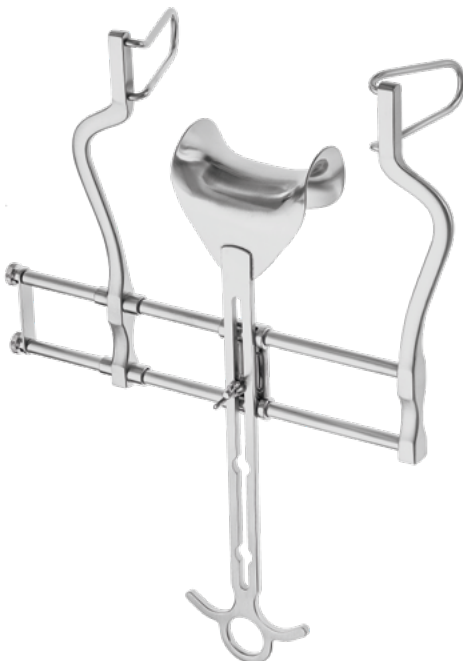

**BALFOUR**

Abdominal Retractor, 180mm spread width,  
lateral wire blades: 50mm

75 x 50mm 170-852-050



# skin and wound.





FOR BLADES #3



<b>Knife Handle #3, 130mm, 5<sup>1</sup>/<sub>8</sub>"</b>	
	110-110-003
with cm/mm scale	110-114-003



<b>Knife Handle #3L</b>	
210mm, 8 <sup>1</sup> / <sub>4</sub> "	110-116-033
360mm, 14"	110-116-133



<b>Knife Handle #7</b>	
165mm, 6 <sup>1</sup> / <sub>2</sub> "	110-130-077

FOR BLADES #4

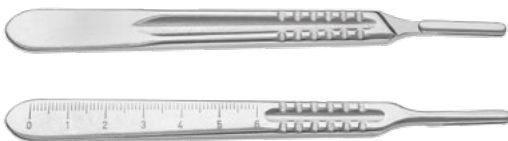

<b>Knife Handle #4, 135mm, 5<sup>1</sup>/<sub>3</sub>"</b>	
	110-140-004
with cm/mm scale	110-141-004



<b>Knife Handle #4L</b>	
210mm, 8 <sup>1</sup> / <sub>4</sub> "	110-144-004



**Button-end Probe,  $\varnothing$  1mm**

115mm, 4 <sup>1</sup> / <sub>2</sub> "	160-102-115
130mm, 5 <sup>1</sup> / <sub>8</sub> "	160-102-130
145mm, 5 <sup>3</sup> / <sub>4</sub> "	160-102-145
160mm, 6 <sup>1</sup> / <sub>4</sub> "	160-102-160
180mm, 7"	160-102-180
200mm, 8"	160-102-200

**$\varnothing$  2mm**

115mm, 4 <sup>1</sup> / <sub>2</sub> "	160-100-115
130mm, 5 <sup>1</sup> / <sub>8</sub> "	160-100-130
145mm, 5 <sup>3</sup> / <sub>4</sub> "	160-100-145
160mm, 6 <sup>1</sup> / <sub>4</sub> "	160-100-160
180mm, 7"	160-100-180
200mm, 8"	160-100-200

**Button-end Probe, with eye,  $\varnothing$  2mm**

115mm, 4 <sup>1</sup> / <sub>2</sub> "	160-108-115
130mm, 5 <sup>1</sup> / <sub>8</sub> "	160-108-130
145mm, 5 <sup>3</sup> / <sub>4</sub> "	160-108-145
160mm, 6 <sup>1</sup> / <sub>4</sub> "	160-108-160
180mm, 7"	160-108-180
200mm, 8"	160-108-200



**Probe,  $\varnothing$  1.5mm**

130mm, 5 <sup>1</sup> / <sub>8</sub> "	160-099-130
145mm, 5 <sup>3</sup> / <sub>4</sub> "	160-099-145
160mm, 6 <sup>1</sup> / <sub>4</sub> "	160-099-160
200mm, 8"	160-099-200

**REDON**Guide Needle, lancet tip, slightly curved,  
with threaded end185mm, 7<sup>1/4</sup>"

8 Charr	165-204-080
10 Charr	165-204-100
12 Charr	165-204-120
14 Charr	165-204-140
16 Charr	165-204-160



## Grooved Director

115mm, 4 <sup>1/2</sup> "	160-107-115
130mm, 5 <sup>1/8</sup> "	160-107-130
145mm, 5 <sup>3/4</sup> "	160-107-145
160mm, 6 <sup>1/4</sup> "	160-107-160
180mm, 7"	160-107-180
200mm, 8"	160-107-200



## Grooved Director, buttoned

130mm, 5 <sup>1/8</sup> "	160-170-130
145mm, 5 <sup>3/4</sup> "	160-170-145
160mm, 6 <sup>1/4</sup> "	160-170-160
180mm, 7"	160-170-180

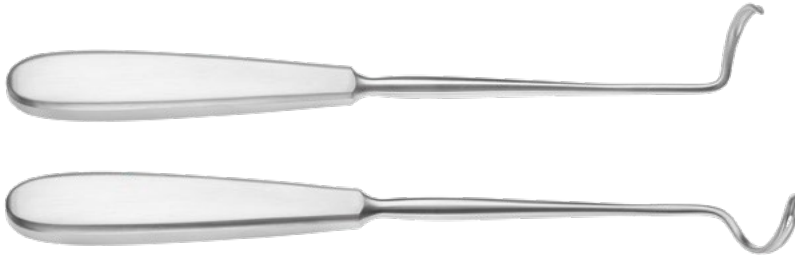

**DESCHAMPS**  
Ligature Needles, sharp

left curved,  
for right hand 180-724-200

right curved,  
for left hand 180-728-200

**blunt**

left curved,  
for right hand 180-726-210

right curved,  
for left hand 180-727-210

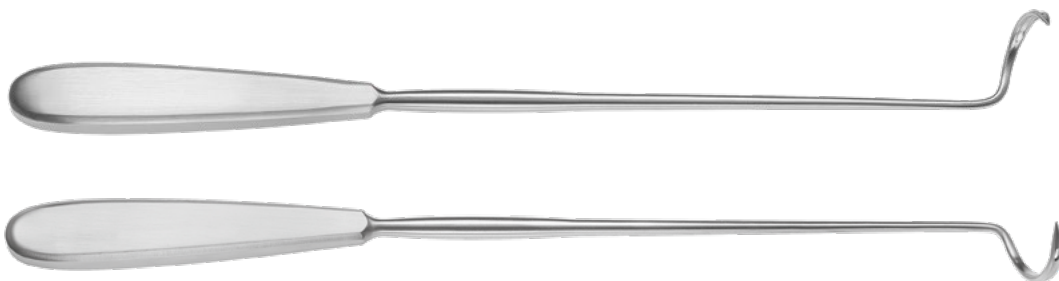
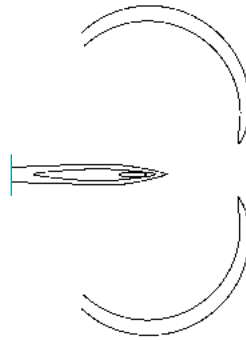

**DESCHAMPS**  
Needle, left curved, sharp, for right hand

270mm, 10<sup>2</sup>/<sub>3</sub>" 180-732-270

right curved, for left hand

270mm, 10<sup>2</sup>/<sub>3</sub>" 180-733-270

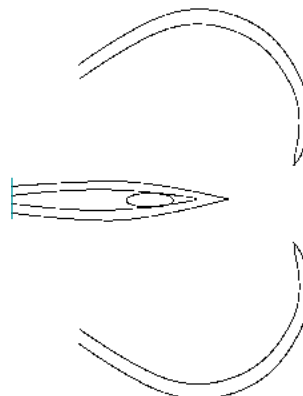



# orthopaedics.





**LISTER**

**Plaster Cast / Bandage Scissors**

90mm, 3 <sup>1</sup> / <sub>2</sub> "	190-165-090
110mm, 4 <sup>1</sup> / <sub>3</sub> "	190-165-110
140mm, 5 <sup>1</sup> / <sub>2</sub> "	190-165-140
180mm, 7"	190-165-180
200mm, 8"	190-165-200
210mm, 8 <sup>1</sup> / <sub>4</sub> "	190-170-210



**TC LISTER**

**Bandage Scissors**

180mm, 7"	190-291-180
-----------	-------------







**Bone Reposition Forceps**

95mm, 3<sup>3</sup>/<sub>4</sub>" 210-651-095

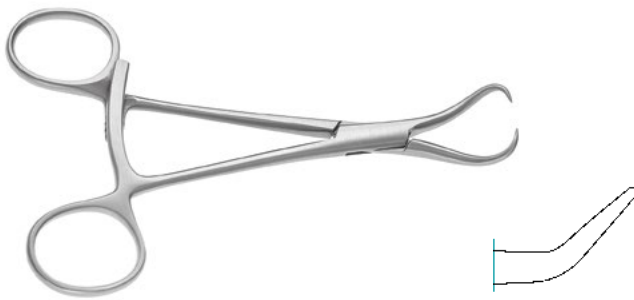

**STEINHAUSER**  
Bone Reposition Forceps,  
extra long ratchet

135mm, 5<sup>1</sup>/<sub>3</sub>" 210-651-135

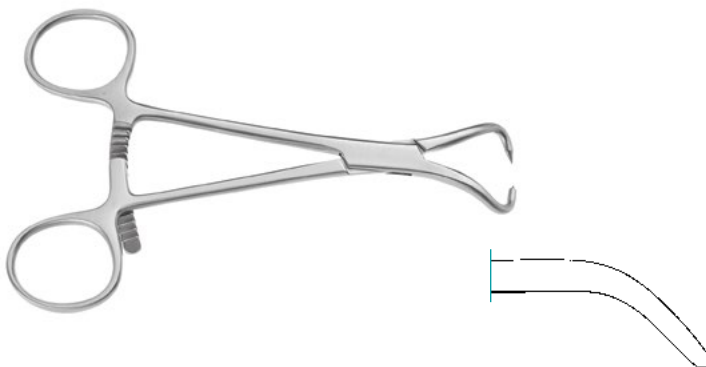

**Bone Reduction Forceps,  
curved, stepped point**

135mm, 5<sup>1</sup>/<sub>3</sub>" 210-665-135

170mm, 6<sup>2</sup>/<sub>3</sub>" 210-665-170

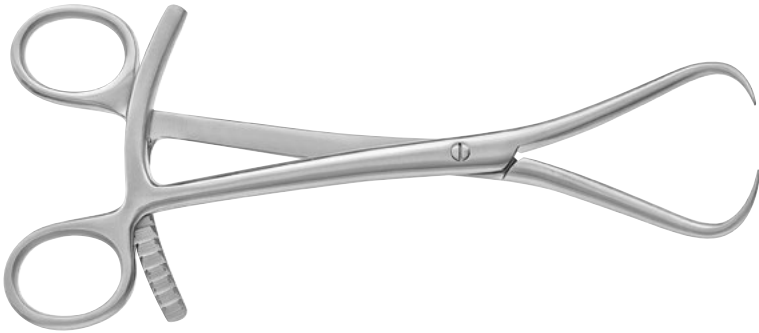

**Reposition Forceps**

200mm, 8"

210-651-200



**Bone Fragment Clamp**

120mm, 4<sup>3/4</sup>"

210-631-120



**MEYER**

**Reposition Forceps for Finger,  
with drill guide**

170mm, 6<sup>2/3</sup>"

210-650-170

200mm, 8"

210-650-200



**Reposition Forceps**

140mm, 5<sup>1/2</sup>"

210-718-140

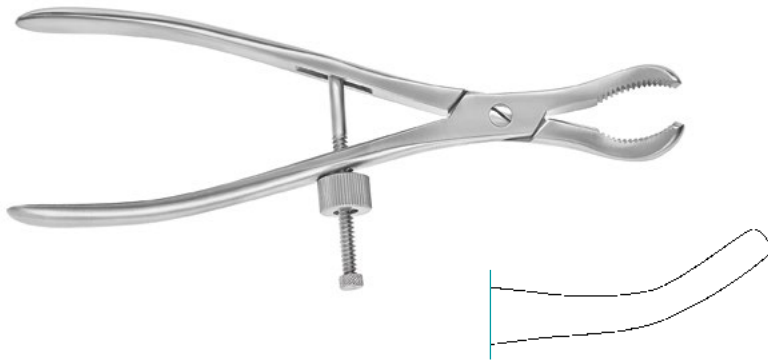

**SETTER**

Bone Holding Forceps, curved, speed lock

160mm, 6 <sup>1</sup> / <sub>4</sub> "	210-719-160
225mm, 8 <sup>7</sup> / <sub>8</sub> "	210-719-220

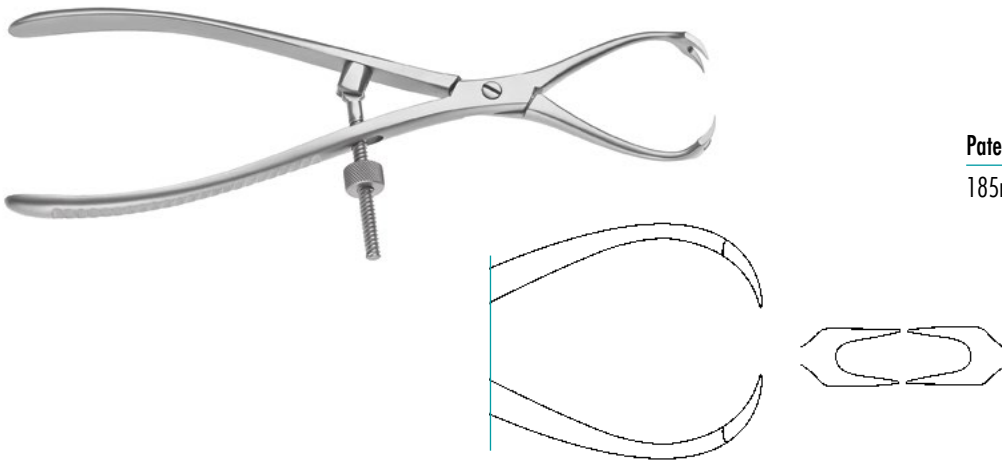

**Patella Holding Forceps, 2x2 sharp teeth**

185mm, 7 <sup>1</sup> / <sub>4</sub> "	210-654-185
--	-------------



**KERN**

Bone Holding Forceps, with ratchet

170mm, 6 <sup>2</sup> / <sub>3</sub> "	210-621-170
240mm, 9 <sup>1</sup> / <sub>2</sub> "	210-621-210

without ratchet

170mm, 6 <sup>2</sup> / <sub>3</sub> "	210-620-170
240mm, 9 <sup>1</sup> / <sub>2</sub> "	210-620-210



**VERBRUGGE**  
Bone Holding Forceps

175mm, 6 <sup>7</sup> / <sub>8</sub> "	210-605-170
250mm, 9 <sup>7</sup> / <sub>8</sub> "	210-605-250
260mm, 10 <sup>1</sup> / <sub>4</sub> "	210-605-260
270mm, 10 <sup>2</sup> / <sub>3</sub> "	210-605-270



**Bone Holding Forceps, self-centering**

150mm, 6"	210-603-150
190mm, 7 <sup>1</sup> / <sub>2</sub> "	210-603-190
240mm, 9 <sup>1</sup> / <sub>2</sub> "	210-603-240
260mm, 10 <sup>1</sup> / <sub>4</sub> "	210-603-260
280mm, 11"	210-603-280



**LAMBOTTE**  
Bone Holding Forceps, movable jaw

220mm, 8 <sup>2</sup> / <sub>3</sub> " 10mm jaw width	210-640-220
270mm, 10 <sup>2</sup> / <sub>3</sub> " 13mm jaw width	210-640-270
300mm, 11 <sup>7</sup> / <sub>8</sub> " 16mm jaw width	210-640-300



**FRIEDMANN**  
 Bone Rongeur, 90°, curved  
 140mm, 5<sup>1</sup>/<sub>2</sub>" 210-642-120

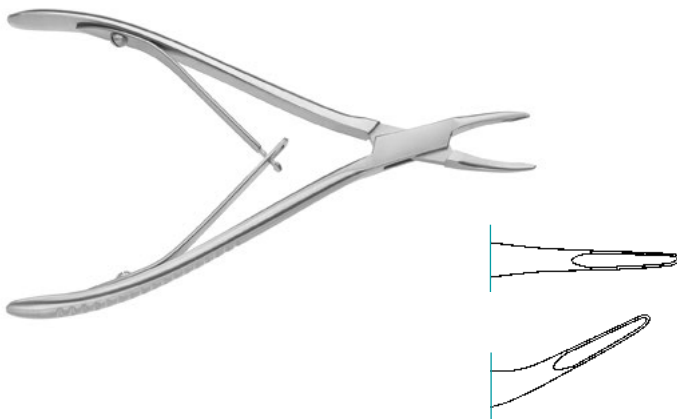

**MINI FRIEDMANN**  
 Bone Rongeur, 1.1mm delicate jaw  
 140mm, 5<sup>1</sup>/<sub>2</sub>"  
 Straight 210-640-150  
 Curved 210-641-150

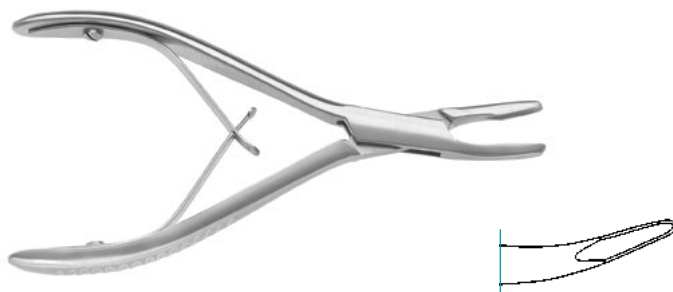

**FRIEDMANN**  
 Bone Rongeur, 140mm, 5<sup>1</sup>/<sub>2</sub>"  
 Curved 210-640-140

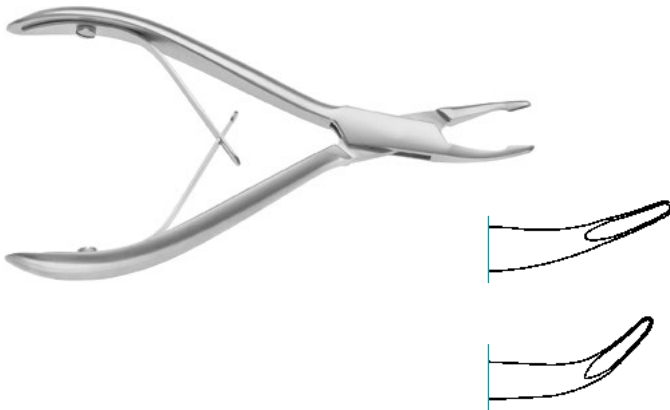

**KLEINERT KUTZ**

Bone Rongeur, 2mm jaw,  
140mm, 5<sup>1</sup>/<sub>2</sub>"

---

Slightly curved	210-642-140
Strongly curved	210-643-140

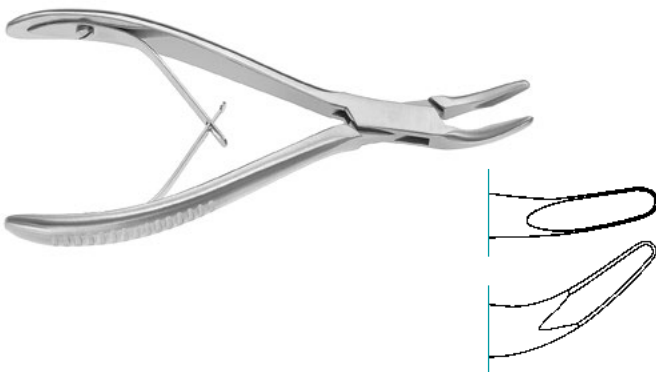

**LUER**

Bone Rongeur, 140mm, 5<sup>1</sup>/<sub>2</sub>"

---

Slightly curved	210-685-150
Strongly curved	210-687-150

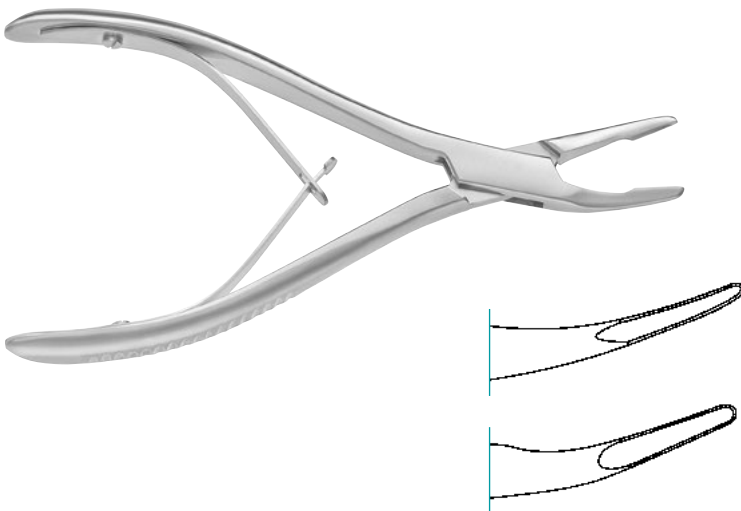

**BEYER**

Bone Rongeur, 3x16mm, 180mm, 7"

---

Curved	210-830-180
Strongly Curved	210-831-180

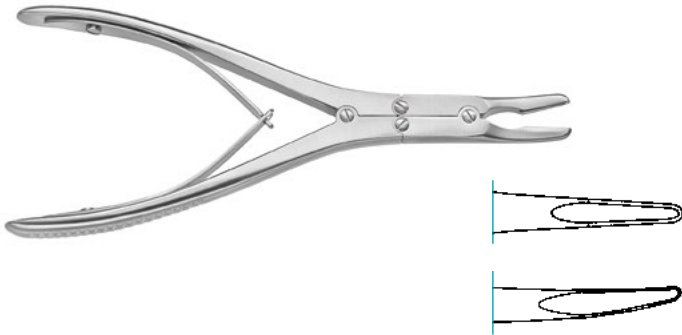

**MINI RUSKIN**

Bone Rongeur, 2mm, 150mm, 6"

Straight	210-802-150
Curved	210-812-150

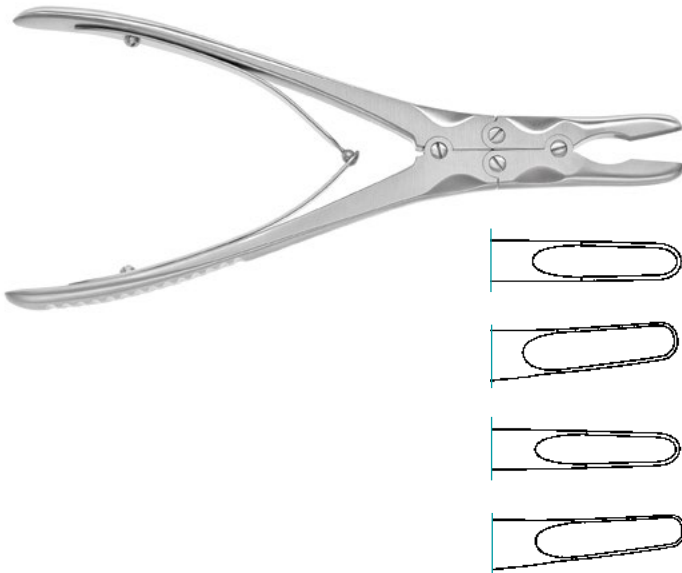

**RUSKIN**

Bone Rongeur, 5mm, 180mm, 7"

Straight	210-800-180
Curved	210-801-180

**4mm**

Straight	210-802-180
Curved	210-803-180



**LITTAUER**  
Bone Cutting Forceps with spring

150mm, 6" 210-397-150

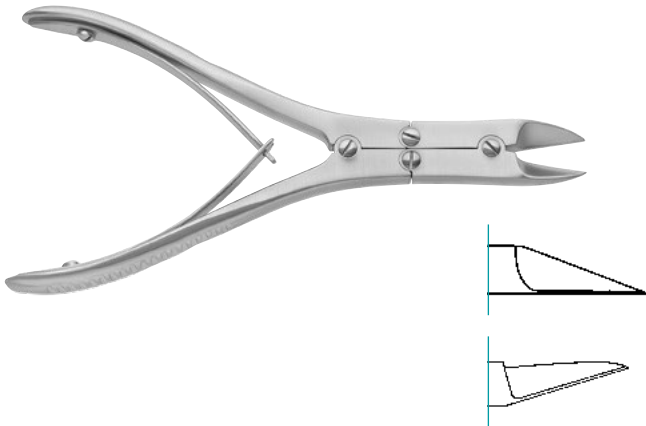

**BOEHLER**  
Bone Cutting Forceps, double action,  
straight

150mm, 6" 210-892-150

curved on flat

150mm, 6" 210-890-150



**LISTON**  
Bone Cutting Forceps, straight

140mm, 5 1/2" 210-934-140

170mm, 6 2/3" 210-934-170

190mm, 7 1/2" 210-934-190

220mm, 8 2/3" 210-934-220

angled

140mm, 5 1/2" 210-935-140

170mm, 6 2/3" 210-935-170

190mm, 7 1/2" 210-935-190

220mm, 8 2/3" 210-935-220

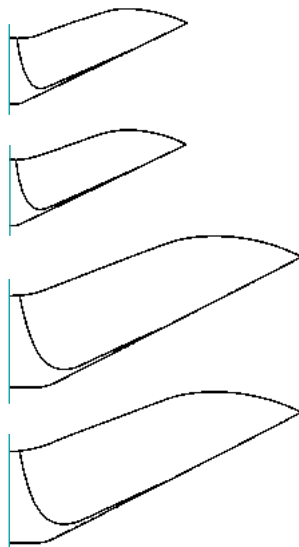
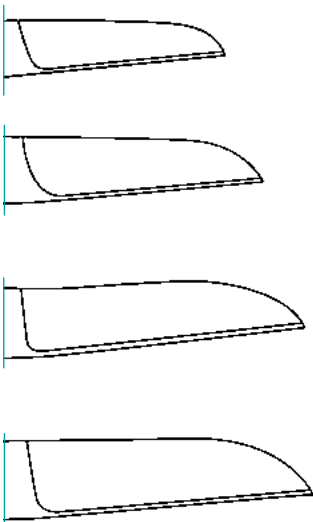





**Bone Hook, 1 tooth, sharp**

245mm, 9<sup>2</sup>/<sub>3</sub>"

170-292-245

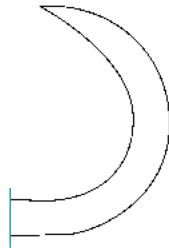

**Bone Lever, 2.8mm**

140mm, 5<sup>1</sup>/<sub>2</sub>"

210-539-110

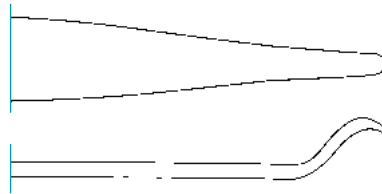

**HOHMANN**

**Bone Lever, 2mm tip, 8mm wide**

160mm, 6<sup>1</sup>/<sub>4</sub>"

210-541-080

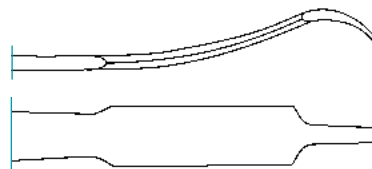

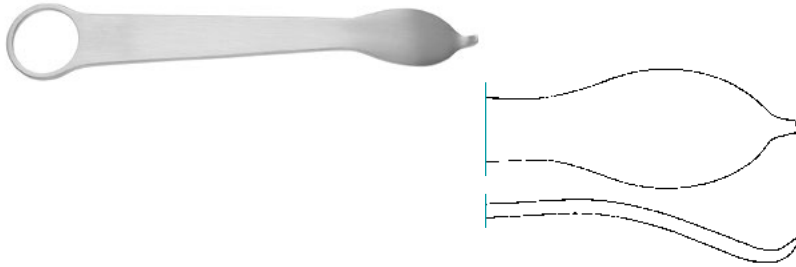

**HOHMANN**

Bone Lever, 15mm wide tip, with finger ring

120mm, 4<sup>3/4</sup>" 210-541-150

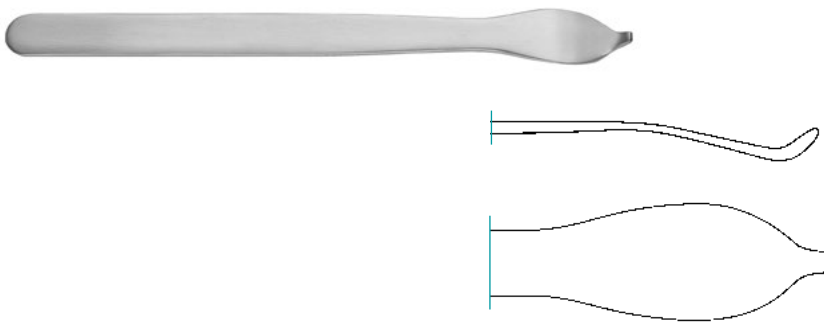

**Mini Bone Lever, 15mm wide tip**

160mm, 6<sup>1/4</sup>" 210-539-150

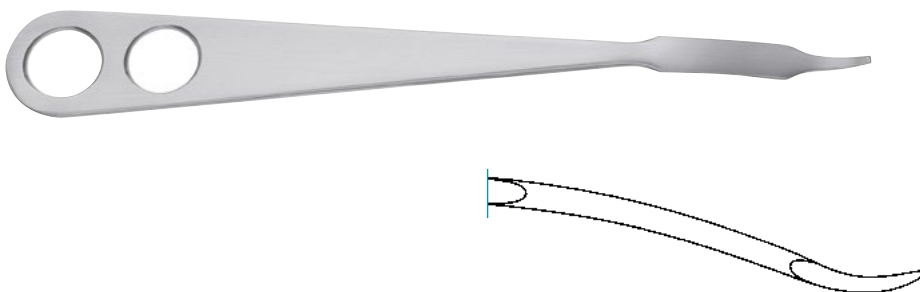

**HOHMANN**

Bone Lever, 240mm, 9<sup>1/2</sup>"

8mm 210-541-108

10mm 210-541-100

18mm 210-541-180

24mm 210-541-240

43mm 210-541-430

70mm 210-541-700



**HOHMANN**  
Bone Lever, 17mm, sharp

240mm, 9<sup>1</sup>/<sub>2</sub>" 210-542-180

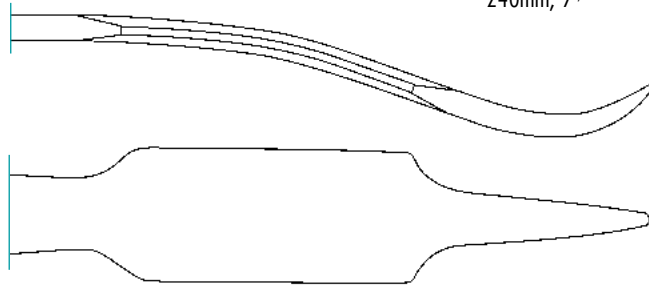

**HOHMANN**  
Bone Lever, 24mm

260mm, 10<sup>1</sup>/<sub>4</sub>" 210-545-220

35mm  
285mm, 11<sup>1</sup>/<sub>4</sub>" 210-545-350

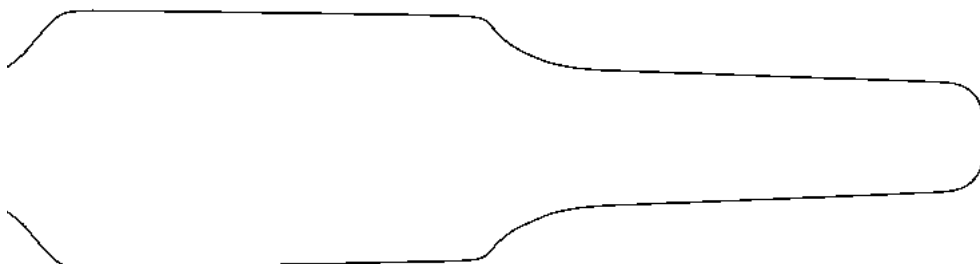
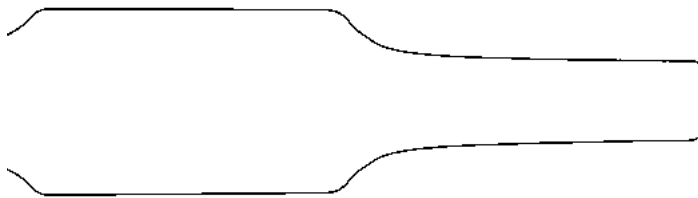
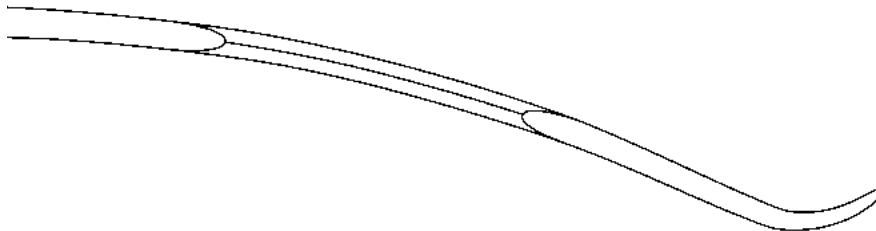

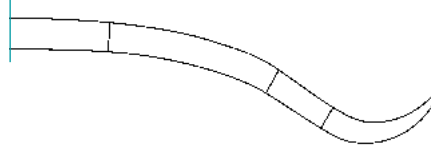

**VERBRUGGE**

Bone Lever, 25mm

200mm, 8" 210-542-025

45mm

230mm, 9" 210-542-045

70mm

250mm, 9<sup>7</sup>/<sub>8</sub>" 210-542-070

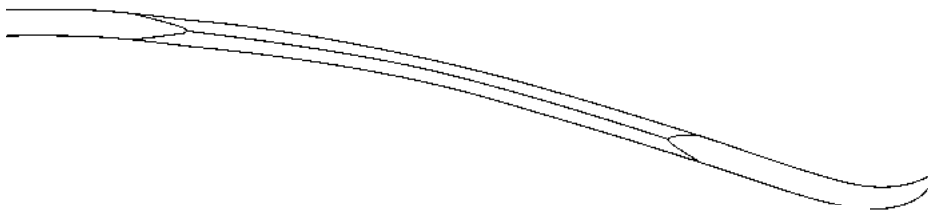

**HOHMANN**

Bone Lever, 43mm

235mm, 9<sup>1</sup>/<sub>4</sub>" 210-543-430





**WILLIGER**  
Elevator, 160mm, 6<sup>1/4</sup>"

5.5mm	210-395-160
7.0mm	210-396-170

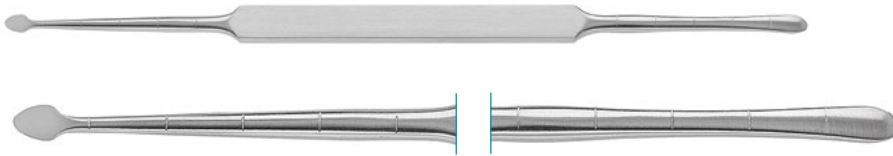

**COTTLE**  
Elevator, double-ended, graduated,  
sharp/sharp

200mm, 8"	420-550-230
-----------	-------------

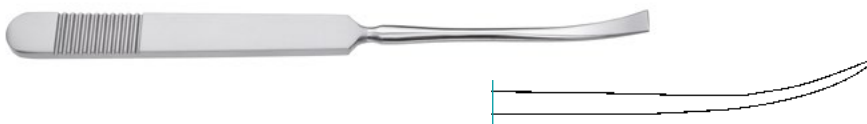

**PENNYBAKER**  
Elevator, sharp, 6mm

150mm, 6"	210-488-170
-----------	-------------



**COBB**  
Elevator, 240mm, 9<sup>1/2</sup>"

9mm	210-401-095
13mm	210-401-127
19mm	210-401-019
25mm	210-401-025
32mm	210-401-032

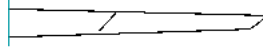

Raspatory, synthetic handle,  
6mm

190mm, 7<sup>1</sup>/<sub>2</sub>" 210-434-180

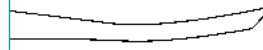

3mm

185mm, 7<sup>1</sup>/<sub>4</sub>" 210-432-185



6mm

185mm, 7<sup>1</sup>/<sub>4</sub>" 210-433-180

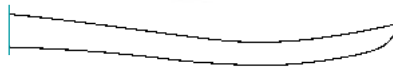

6mm

185mm, 7<sup>1</sup>/<sub>4</sub>" 210-432-180





**WILLIGER**

Double Curette, oval/oval, 140mm, 5<sup>1</sup>/<sub>2</sub>"

A #00/0 (Ø 2.5 / 3.0mm)	210-216-000
B #0/1 (Ø 3.0 / 3.5mm)	210-216-001
C #1/2 (Ø 3.5 / 4.2mm)	210-216-002

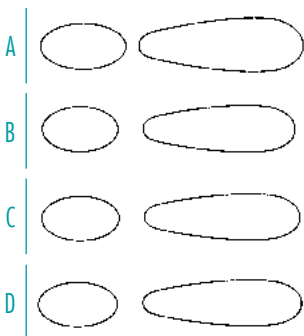

**VOLKMANN**

Double Curette, 130mm, 5<sup>1</sup>/<sub>8</sub>"

A 6.5 / 7.7mm	210-210-130
<b>140mm, 5<sup>1</sup>/<sub>2</sub>"</b>	
B 6.2 / 6.8mm	210-210-140
<b>170mm, 6<sup>2</sup>/<sub>3</sub>"</b>	
C 6.8 / 6.8mm	210-210-170
<b>200mm, 8"</b>	
D 6.2 / 7.5mm	210-210-200

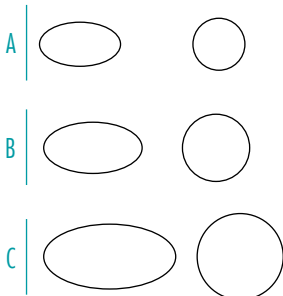

**VOLKMANN**

Double Curette, 130mm, 5<sup>1</sup>/<sub>8</sub>"

A 6.8 / 6.3mm	210-211-130
<b>160mm, 6<sup>1</sup>/<sub>4</sub>"</b>	
B 9.0 / 7.0mm	210-211-160
<b>200mm, 8"</b>	
C 11.0 / 9.0mm	210-211-200

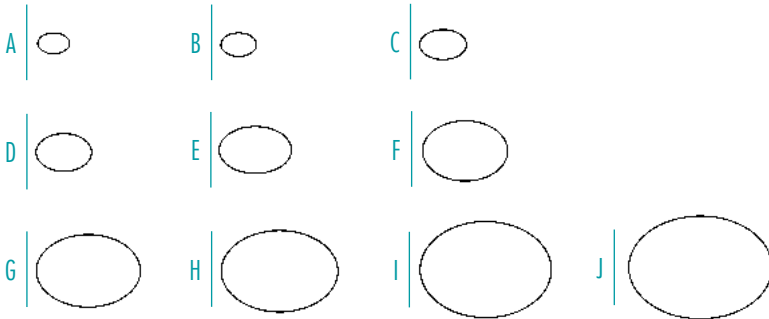
**VOLKMANN**Bone Curette, 170mm, 6<sup>2</sup>/<sub>3</sub>"

A #0000	210-304-400
B #000	210-304-300
C #00	210-304-200
D #0	210-304-100
E #1	210-304-010
F #2	210-304-020
G #3	210-304-030
H #4	210-304-040
I #5	210-304-050
J #6	210-304-060

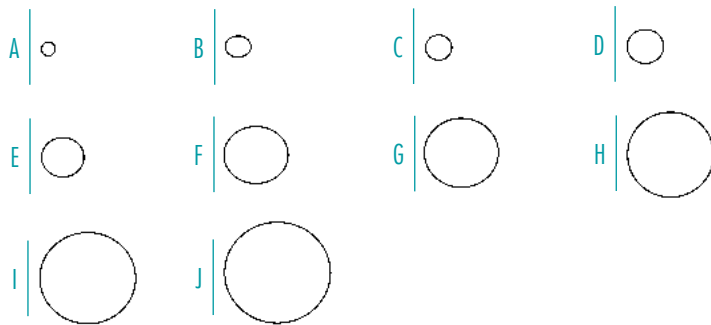
**BRUNS**Bone Curette, round, 170mm, 6<sup>2</sup>/<sub>3</sub>"

A #0000	210-306-400
B #000	210-306-300
C #00	210-306-200
D #0	210-306-100
E #1	210-306-010
F #2	210-306-020
G #3	210-306-030
H #4	210-306-040
I #5	210-306-050
J #6	210-306-060

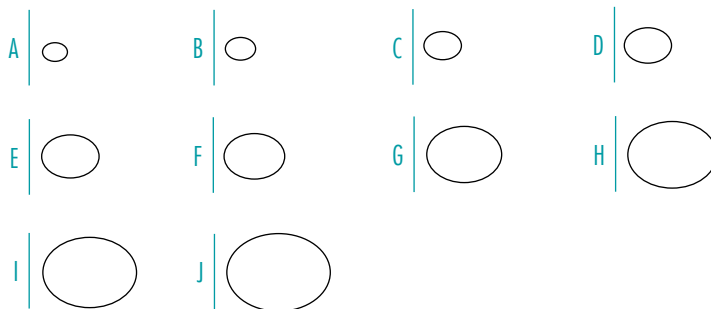
**BRUNS**Bone Curette, synthetic handle, 170mm, 6<sup>2</sup>/<sub>3</sub>"

A #0000, 2.5mm	210-302-100
B #000, 3.0mm	210-302-101
C #00, 3.7mm	210-302-102
D #0, 4.7mm	210-302-103
E #1, 5.7mm	210-302-104
F #2, 6.0mm	210-302-105
G #3, 7.4mm	210-302-106
H #4, 8.8mm	210-302-107
I #5, 9.2mm	210-302-108
J #6, 10.3mm	210-302-109



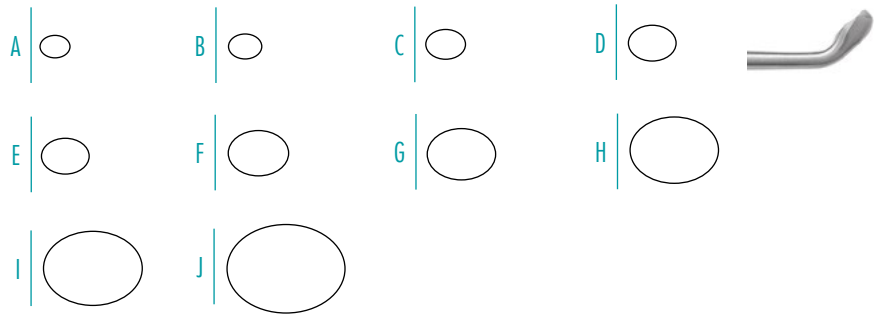

**VOLKMANN BRUNS**  
**Bone Curette, 230mm, 9"**  
**straight jaw**

A #0000	210-314-400
B #000	210-314-300
C #00	210-314-200
D #0	210-314-100
E #1	210-314-001
F #2	210-314-002
G #3	210-314-003
H #4	210-314-004
I #5	210-314-005
J #6	210-314-006

**angled**

A #0000	210-315-400
B #000	210-315-300
C #00	210-315-200
D #0	210-315-100
E #1	210-315-001
F #2	210-315-002
G #3	210-315-003
H #4	210-315-004
I #5	210-315-005
J #6	210-315-006

**PARTSCH****Osteotome, 140mm, 5<sup>1</sup>/<sub>2</sub>"**

4mm	210-100-004
6mm	210-100-006
8mm	210-100-008
10mm	210-100-010
12mm	210-100-012

**PARTSCH****Chisel, 135mm, 5<sup>1</sup>/<sub>3</sub>"**

2mm	210-302-135
3mm	210-303-135
5mm	210-305-135
6mm	210-306-135
7mm	210-307-135
8mm	210-308-135

**170mm, 6<sup>2</sup>/<sub>3</sub>"**

2mm	210-302-170
3mm	210-303-170
5mm	210-305-170
6mm	210-306-170
7mm	210-307-170
8mm	210-308-170

**PARTSCH****Gouge, 140mm, 5<sup>1</sup>/<sub>2</sub>"**

2mm	210-109-002
3mm	210-109-003
4mm	210-109-004
5mm	210-109-005
6mm	210-109-006
7mm	210-109-007
8mm	210-109-008

**170mm, 6<sup>2</sup>/<sub>3</sub>"**

2mm	210-110-002
3mm	210-110-003
4mm	210-110-004
5mm	210-110-005
6mm	210-110-006
7mm	210-110-007
8mm	210-110-008



**COTLE**

Osteotome with depth marking, 180mm, 7"

4mm	210-487-004
7mm	210-487-007
8mm	210-487-008
10mm	210-487-010
12mm	210-487-012



**MINI LAMBOTTE**

Osteotome, 125mm, 5"

2mm	210-136-002
3mm	210-136-003
4mm	210-136-004
5mm	210-136-005
6mm	210-136-006
7mm	210-136-007
8mm	210-136-008
9mm	210-136-009
10mm	210-136-010
12mm	210-136-012
14mm	210-136-014
15mm	210-136-015



**MINI LAMBOTTE**

Osteotome, curved, 125mm, 5"

2mm	210-137-002
4mm	210-137-005
6mm	210-137-007
8mm	210-137-009
10mm	210-137-011
12mm	210-137-013

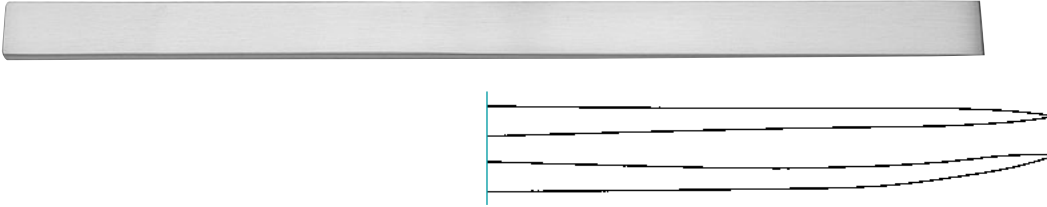

**LAMBOTTE**  
Osteotome, 240mm, 9<sup>1</sup>/<sub>2</sub>"  
straight

4mm	210-132-004
6mm	210-132-006
8mm	210-132-008
10mm	210-132-010
12mm	210-132-012
15mm	210-132-015
20mm	210-132-020
25mm	210-132-025

**curved**

4mm	210-133-004
6mm	210-133-006
8mm	210-133-008
10mm	210-133-010
12mm	210-133-012
15mm	210-133-015
20mm	210-133-020
25mm	210-133-025



**WALTER**  
Osteotome, black, 190mm, 7<sup>1</sup>/<sub>2</sub>"

2mm	420-580-002
3mm	420-580-003
4mm	420-580-004
5mm	420-580-005



**LUCAE**  
Mallet, Ø 25mm  
140g

190mm, 7<sup>1/2</sup>" 210-231-190



**PARTSCH**  
Mallet, Ø 22mm  
120g

180mm, 7" 210-225-180



Mallet, 2 interchangeable plastic discs,  
Ø 25mm  
140g

185mm, 7<sup>1/4</sup>" 210-264-140

Spare Discs, pair 210-265-000



**HAJEK**  
Mallet, Ø 27mm  
140g

220mm, 8<sup>2/3</sup>" 210-244-220

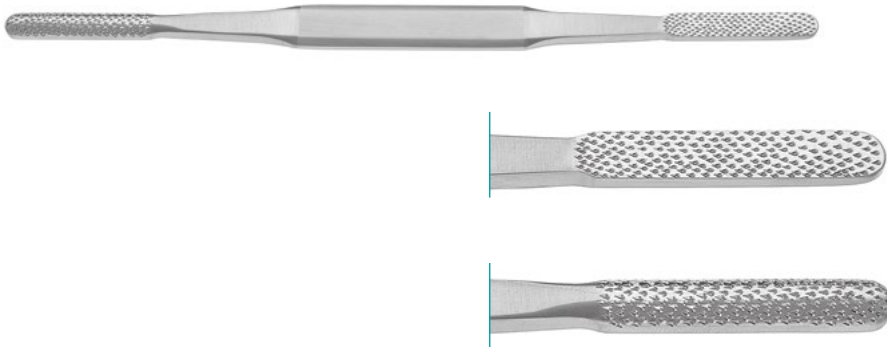

**FOMON**

Rasp, fine, double-ended, 7.5mm / 6.5mm

215mm, 8<sup>1</sup>/<sub>2</sub>" 420-661-000



**FOMON**

Rasp, coarse, double-ended,  
7.0mm / 8.0mm

215mm, 8<sup>1</sup>/<sub>2</sub>" 420-660-000



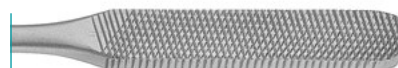
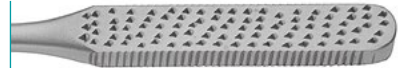

**KLEINERT KUTZ**  
Rasp, double-ended, 4 sides  
220mm, 8<sup>2/3</sup>" 420-656-000

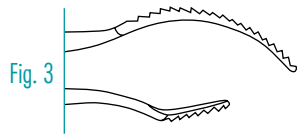
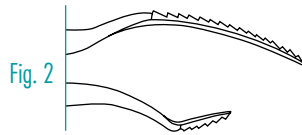

**MILLER**  
Rasp, 90° cross-serrated, backwards cutting,  
180mm, 7"

Fig. 1 8mm / 5mm 500-387-000

Fig. 2 6mm / 4mm 500-384-010

Fig. 3 6mm / 5mm 500-386-045



**TC Wire Twisting Forceps**

150mm, 6"

180-501-150



**TC Wire Holding Clamp, round jaw**

130mm, 5<sup>1</sup>/<sub>8</sub>"

180-569-130



**Wire Holding Forceps**

140mm, 5<sup>1</sup>/<sub>2</sub>"

200-515-140





**Flat Nose Plier, distal jaw, smooth**

140mm, 5<sup>1</sup>/<sub>2</sub>" 180-507-140



**Flat Nose Plier, serrated jaw**

140mm, 5<sup>1</sup>/<sub>2</sub>" 180-511-140



**Flat Nose Plier, with groove**

160mm, 6<sup>1</sup>/<sub>4</sub>" 200-518-160



Wire and Pin Bender / up to 3.2mm

150mm, 6"

200-204-150



**LOUTE**  
Wire Tightener

210mm, 8<sup>1</sup>/<sub>4</sub>"

200-513-210

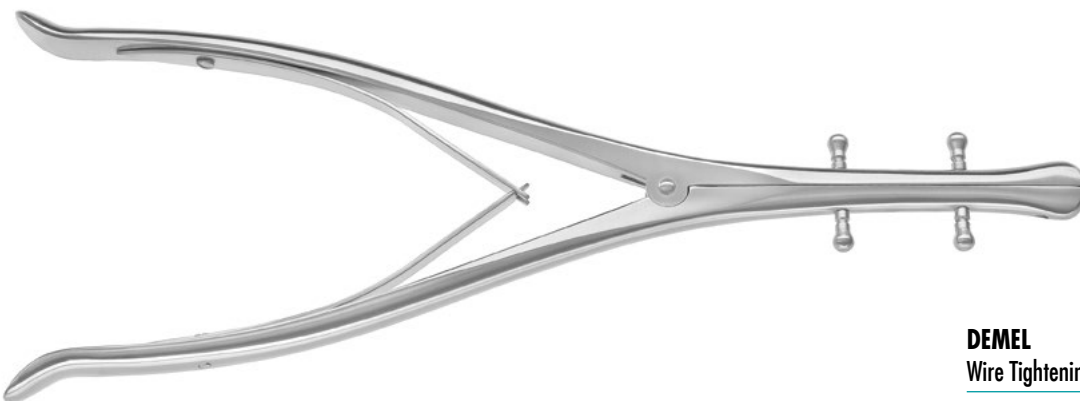

**DEMEL**  
Wire Tightening- and Twisting Forceps

270mm, 10<sup>2</sup>/<sub>3</sub>"

200-755-270

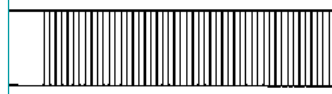

**Wire Gripper, parallel closure**

185mm, 7<sup>1</sup>/<sub>4</sub>"

200-513-185





**Combined Wire Cutter and Gripper**

180mm, 7"

180-512-185

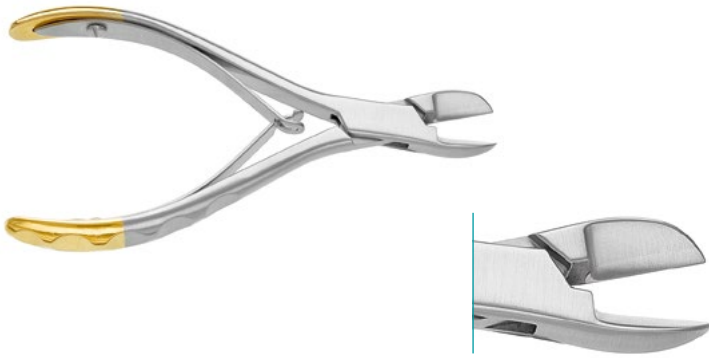





**CUT**   
 HARD max. 0.6mm  
 SOFT max. 1.0mm

**TC Wire Cutter**

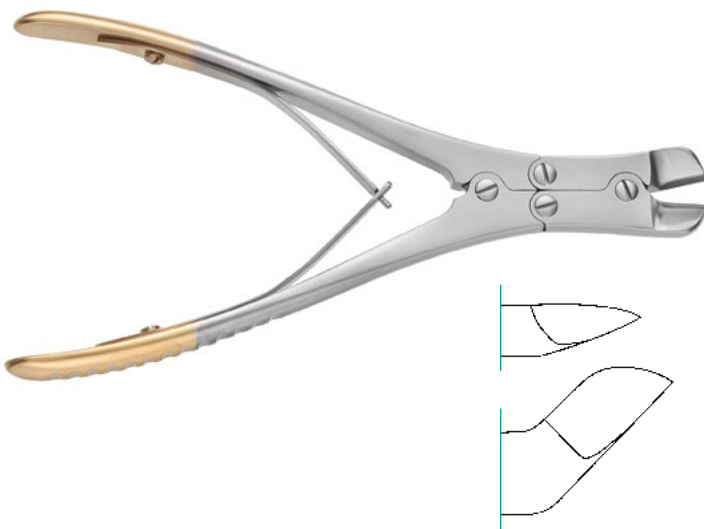
120mm, 4<sup>3/4</sup>" 200-500-120



**CUT**   
 HARD max. 1.6mm  
 SOFT max. 2.0mm

**TC Wire Cutter, angled**

170mm, 6<sup>2/3</sup>" 200-500-160

**REILL**  
**TC Wire Cutter, angled**

220mm, 8<sup>2/3</sup>" 200-500-220

**CUT**   
 HARD max. 1.8mm  
 SOFT max. 2.2mm





**CUT**   
 HARD max. 2.2mm  
 SOFT max. 3.0mm

**TC Wire Cutter, 12° angled jaw**



235mm, 9<sup>1/4</sup>" 200-503-235



**CUT**    
 HARD max. 2.5mm  
 SOFT max. 3.5mm

**TC Front Wire Cutter**  
 220mm, 8<sup>2</sup>/<sub>3</sub>" 200-506-220



**CUT**    
 HARD max. 1.6mm  
 SOFT max. 2.0mm

**TC Flush Wire Cutter**  
 180mm, 7" 200-508-180



**CUT**    
 UP TO 3.2mm

**TC Wire Cutter, double action**  
 240mm, 9<sup>1</sup>/<sub>2</sub>" 200-522-240



CUT    
UP TO 6.0mm

**TC Front Cutter**

380mm, 15"

200-500-380

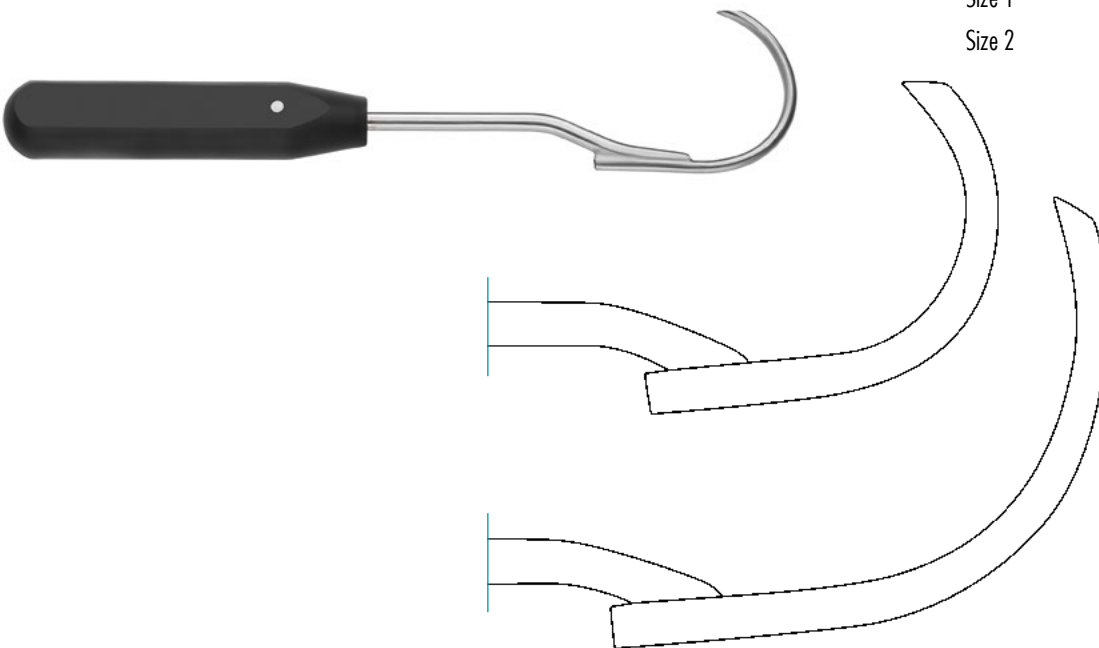

**Wire Guide, synthetic handle, 210mm, 8<sup>1</sup>/<sub>4</sub>"**

Size 1

180-751-018

Size 2

180-751-020



**T-Handle, incl. key**

Jacob Chuck 200-157-001



T-Handle Drill, 1.0 - 6.0mm, cannulated,  
Ø 5.2mm

Universal Chuck 200-157-100



**Depth Gauge**

110mm, 4 <sup>1</sup> / <sub>3</sub> "	30mm screw	200-200-014
160mm, 6 <sup>1</sup> / <sub>4</sub> "	50mm screw	200-200-016
200mm, 8"	70mm screw	200-200-018
200mm, 8"	80mm screw	200-200-080
280mm, 11"	120mm screw	200-200-120



**A**  
Screw Driver, synthetic handle,  
hexagonal,  
SW 1,5

120mm, 4 <sup>3/4</sup> "	200-603-120
250mm, 9 <sup>7/8</sup> "	200-608-200

**Screw Holding Sheath for 200-605-200**

200-603-205



**B**  
Screw Driver, synthetic handle,  
hexagonal,  
SW 2,5

200mm, 8"	200-604-220
250mm, 9 <sup>7/8</sup> "	200-604-200

**Screw Holding Sheath for 200-604-200**

200-604-204



**C**  
Screw Driver, synthetic handle,  
hexagonal,  
SW 3,5

250mm, 9 <sup>7/8</sup> "	200-605-200
---------------------------	-------------

**Screw Holding Sheath for 200-605-200**

200-603-205





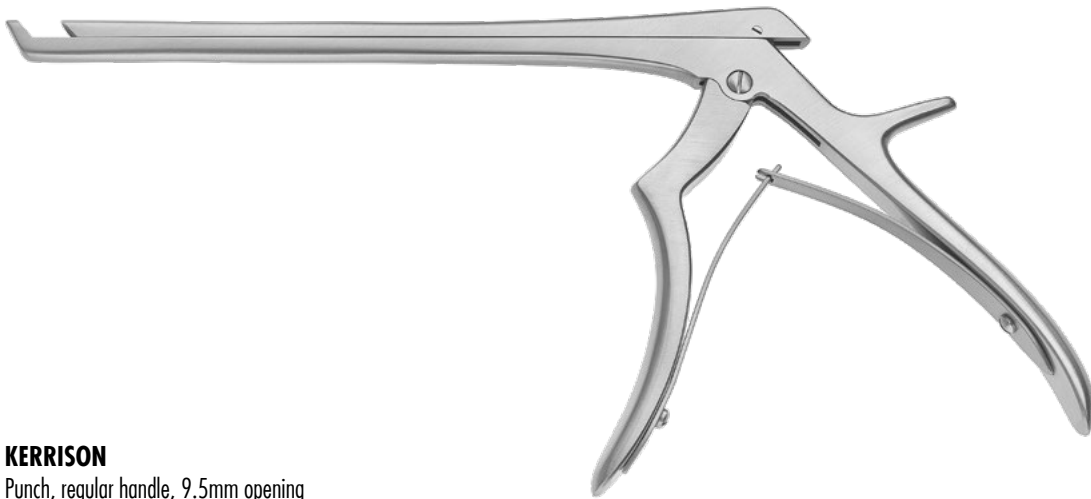

**KERRISON**

Punch, regular handle, 9.5mm opening



40° upwards cutting  
180mm, 7"

1mm	250-400-181
2mm	250-400-182
3mm	250-400-183
4mm	250-400-184
5mm	250-400-185
6mm	250-400-186

200mm, 8"

1mm	250-400-201
2mm	250-400-202
3mm	250-400-203
4mm	250-400-204
5mm	250-400-205
6mm	250-400-206

230mm, 9"

1mm	250-400-231
2mm	250-400-232
3mm	250-400-233
4mm	250-400-234
5mm	250-400-235
6mm	250-400-236



90° upwards cutting  
180mm, 7"

1mm	250-410-181
2mm	250-410-182
3mm	250-410-183
4mm	250-410-184
5mm	250-410-185
6mm	250-410-186

200mm, 8"

1mm	250-410-201
2mm	250-410-202
3mm	250-410-203
4mm	250-410-204
5mm	250-410-205
6mm	250-410-206

230mm, 9"

1mm	250-410-231
2mm	250-410-232
3mm	250-410-233
4mm	250-410-234
5mm	250-410-235
6mm	250-410-236



40° downwards cutting  
180mm, 7"

1mm	250-420-181
2mm	250-420-182
3mm	250-420-183
4mm	250-420-184
5mm	250-420-185
6mm	250-420-186

200mm, 8"

1mm	250-420-201
2mm	250-420-202
3mm	250-420-203
4mm	250-420-204
5mm	250-420-205
6mm	250-420-206

230mm, 9"

1mm	250-420-231
2mm	250-420-232
3mm	250-420-233
4mm	250-420-234
5mm	250-420-235
6mm	250-420-236



90° downwards cutting  
180mm, 7"

1mm	250-430-181
2mm	250-430-182
3mm	250-430-183
4mm	250-430-184
5mm	250-430-185
6mm	250-430-186

200mm, 8"

1mm	250-430-201
2mm	250-430-202
3mm	250-430-203
4mm	250-430-204
5mm	250-430-205
6mm	250-430-206

230mm, 9"

1mm	250-430-231
2mm	250-430-232
3mm	250-430-233
4mm	250-430-234
5mm	250-430-235
6mm	250-430-236

All Kerrison instruments are available with CERACUT® coating. Code number + CC (e.g. 250-400-181CC)

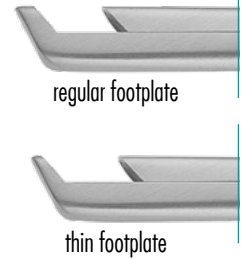
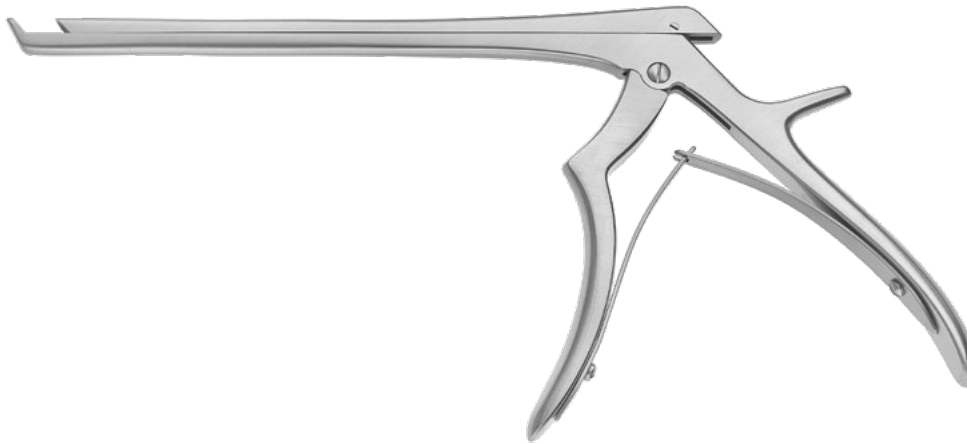
**KERRISON**

Punch, regular handle, thin footplate,  
9.5mm opening

40° upwards cutting 180mm, 7"		90° upwards cutting 180mm, 7"		40° downwards cutting 180mm, 7"		90° downwards cutting 180mm, 7"	
1mm	250-401-181	1mm	250-411-181	1mm	250-421-181	1mm	250-431-181
2mm	250-401-182	2mm	250-411-182	2mm	250-421-182	2mm	250-431-182
3mm	250-401-183	3mm	250-411-183	3mm	250-421-183	3mm	250-431-183
4mm	250-401-184	4mm	250-411-184	4mm	250-421-184	4mm	250-431-184
5mm	250-401-185	5mm	250-411-185	5mm	250-421-185	5mm	250-431-185
200mm, 8"		200mm, 8"		200mm, 8"		200mm, 8"	
1mm	250-401-201	1mm	250-411-201	1mm	250-421-201	1mm	250-431-201
2mm	250-401-202	2mm	250-411-202	2mm	250-421-202	2mm	250-431-202
3mm	250-401-203	3mm	250-411-203	3mm	250-421-203	3mm	250-431-203
4mm	250-401-204	4mm	250-411-204	4mm	250-421-204	4mm	250-431-204
5mm	250-401-205	5mm	250-411-205	5mm	250-421-205	5mm	250-431-205
230mm, 9"		230mm, 9"		230mm, 9"		230mm, 9"	
1mm	250-401-231	1mm	250-411-231	1mm	250-421-231	1mm	250-431-231
2mm	250-401-232	2mm	250-411-231	2mm	250-421-231	2mm	250-431-231
3mm	250-401-233	3mm	250-411-231	3mm	250-421-231	3mm	250-431-231
4mm	250-401-234	4mm	250-411-231	4mm	250-421-231	4mm	250-431-231
5mm	250-401-235	5mm	250-411-231	5mm	250-421-231	5mm	250-431-231

# ENT.

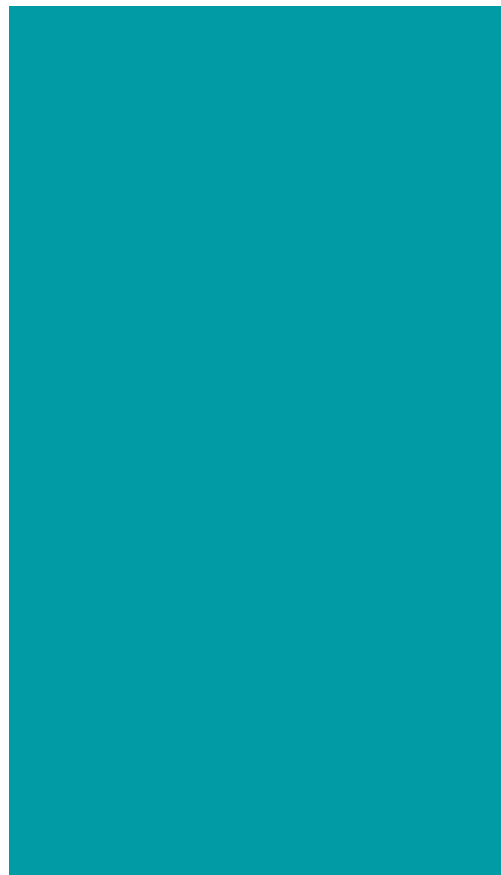

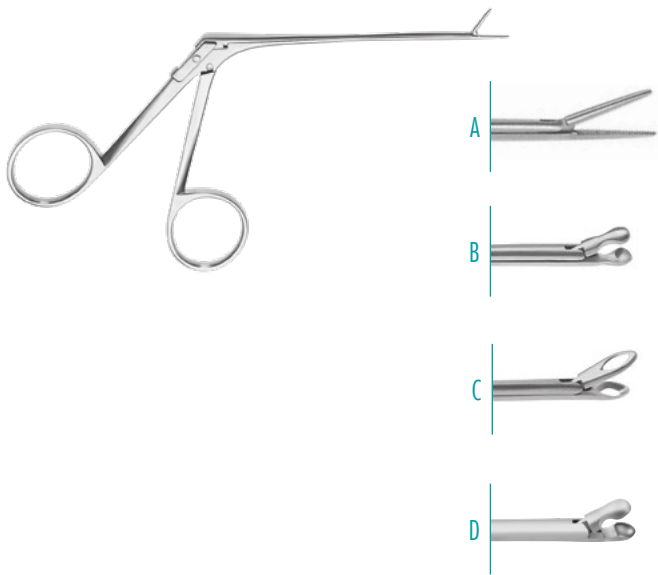

**A** Hartmann Aural Forceps, straight, serrated

1 x 8mm 410-210-085

**B** Hartmann-Herzfeld Ear Forceps, straight, 87mm working length

2.5mm spoon 410-338-136

**C** Struempel Ear Forceps, straight, 87mm working length

2.5 x 7.0mm 410-338-134

**D** Ormerod Micro Cupped Forceps, straight, round cup, 80mm working length

3.0 x 1.7mm 410-423-000

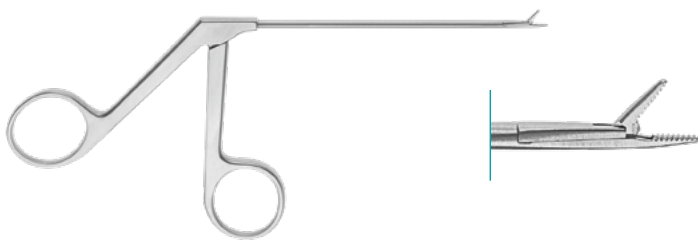

**Micro Aural Forceps with tubular shaft, straight, 80mm working length**

0.8 x 3.5mm 410-330-000



**Troeltsch Aural Tissue Forceps, 1 x 2 teeth, knee bent**

125mm 410-377-120



**House Curette, sharp, double ended,  
oval cups, strongly curved, 1.0 x 1.2mm**  
150mm 410-330-000



**Williger Double Curette, oval/oval  
#0 / 1 (Ø 3.0 / 3.5mm)**  
140mm 210-216-001

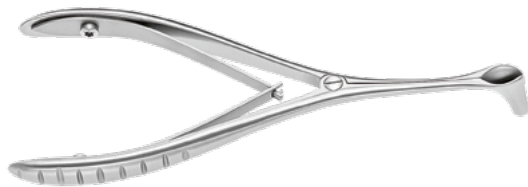

**HALLE-TIECK**  
**Nasal Speculum, screw joint,  
17.5mm blade length**  
130mm 420-140-135

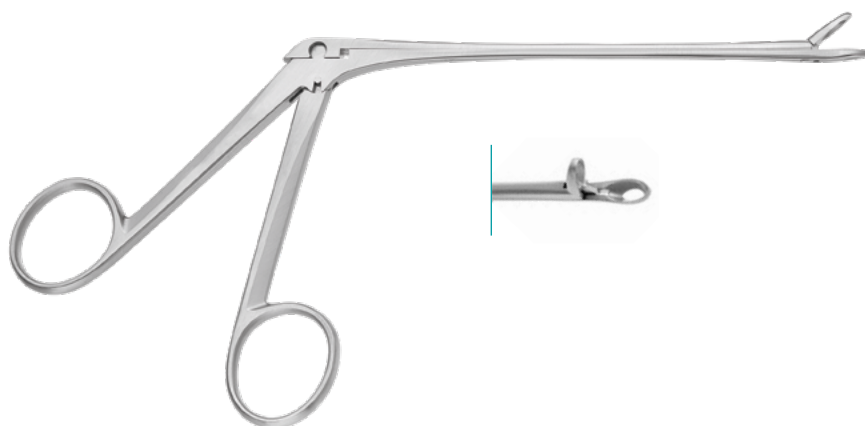

**Blakesley Nasal Forceps,  
150mm working length**  
3.5mm 252-035-150  
4.0mm 252-040-150  
5.0mm 252-050-150



**Noyes Nasal Forceps,  
115mm working length**

fenestrated jaw 252-527-115

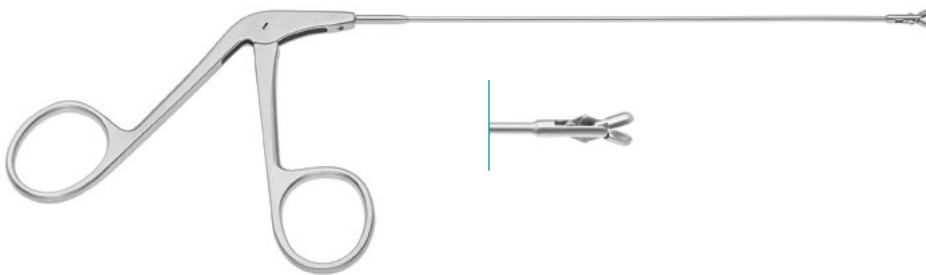

**Biopsy and Grasping Forceps,  
delicate pattern,  
140mm working length**

3mm oval cup 252-503-140



**Struempel Nasal Forceps with  
oval fenestrated cupped jaws  
120mm working length**

straight 252-031-120



**Hurd Elevator**

230mm 430-522-230



**Green Retractor, 20 x 23mm**

220mm 170-319-220



**Lange Choana Hook**

230mm 420-413-230



**Laryngeal mirror with hexagonal handle,  
180mm**

Fig. 00, Ø 8mm 230-330-008  
 Fig. 1, Ø 12mm 230-330-012  
 Fig. 3, Ø 16mm 230-330-016  
 Fig. 5, Ø 20mm 230-330-020

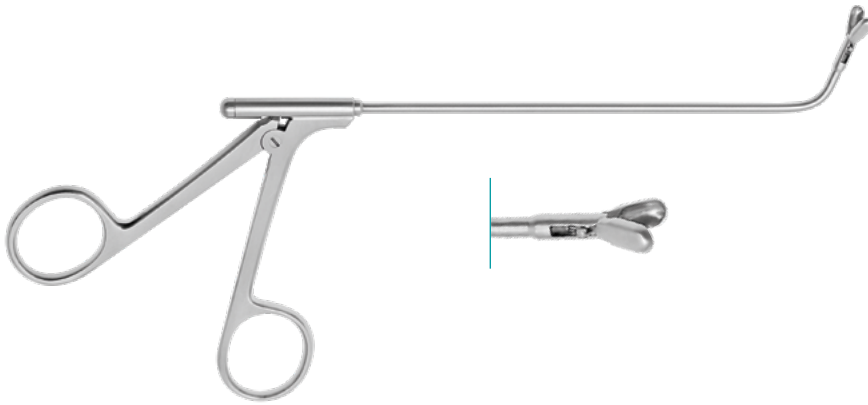

**Biopsy Forceps, vertical action,  
70° curved up, 4 x 8mm  
130mm working length**

70° curved up	252-670-120
110° curved backwards	252-770-120

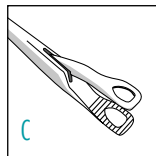
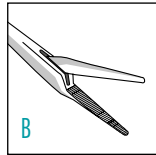
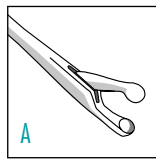
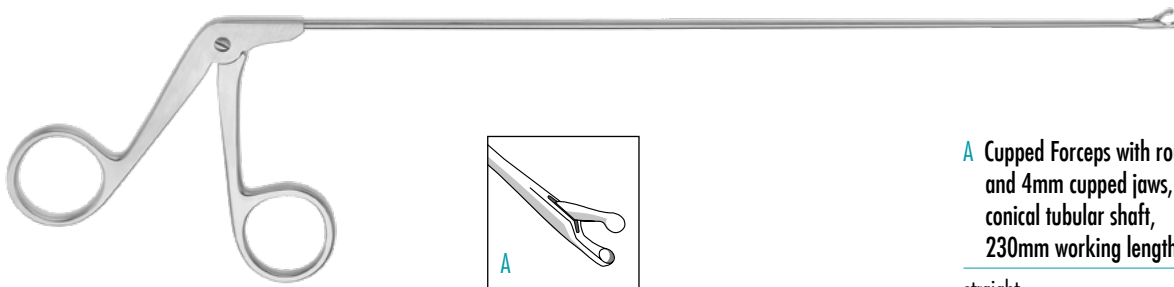

**A Cupped Forceps with round 2mm  
and 4mm cupped jaws,  
conical tubular shaft,  
230mm working length**

straight	100-700-001
----------	-------------

**B Alligator Forceps, standard model,  
conical tubular shaft 2mm,  
230mm working length**

straight, serrated	100-700-020
--------------------	-------------

**C Alligator Forceps, standard model,  
conical tubular shaft 2mm,  
triangular jaws, 230mm working length**

straight	100-700-026
----------	-------------





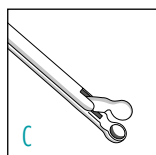
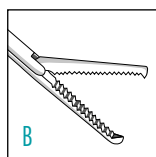
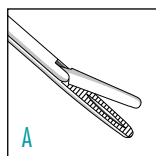
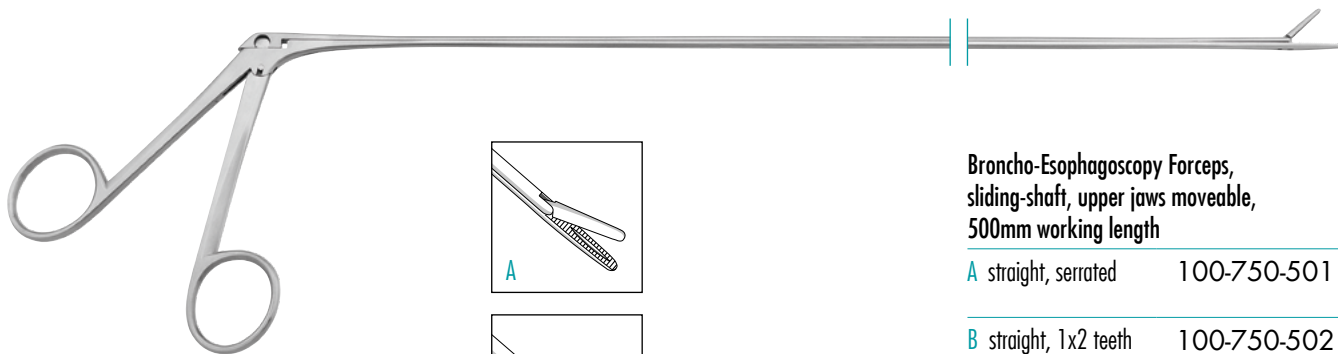

**Broncho-Esophagoscopy Forceps,  
sliding-shaft, upper jaws moveable,  
500mm working length**

- |                         |             |
|-------------------------|-------------|
| A straight, serrated    | 100-750-501 |
| B straight, 1x2 teeth   | 100-750-502 |
| C straight, cupped jaws | 100-750-504 |

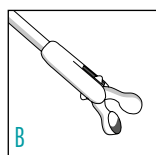
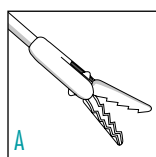
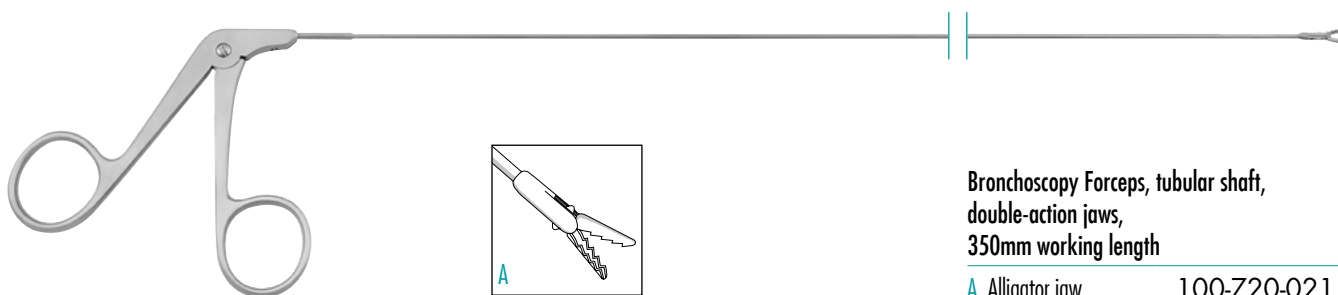

**Bronchoscopy Forceps, tubular shaft,  
double-action jaws,  
350mm working length**

- |                       |             |
|-----------------------|-------------|
| A Alligator jaw       | 100-720-021 |
| B straight, round cup | 100-720-023 |

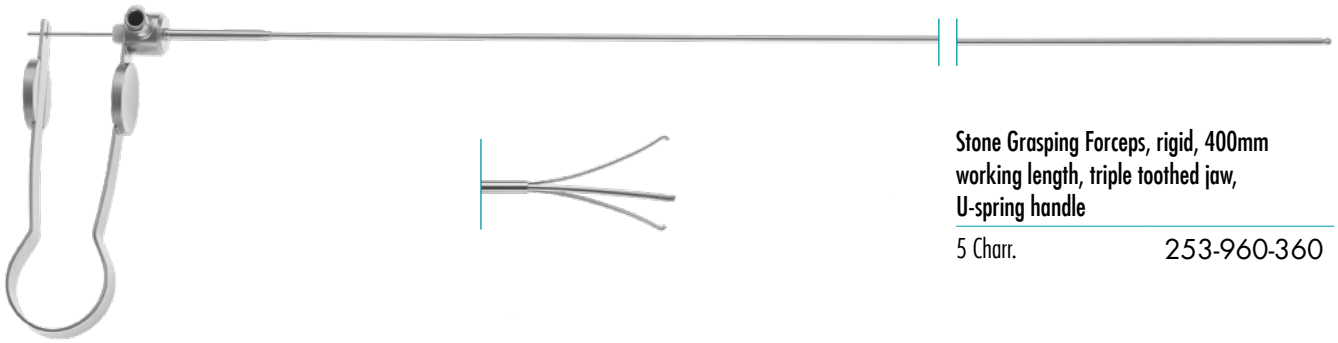

Stone Grasping Forceps, rigid, 400mm working length, triple toothed jaw, U-spring handle

5 Charr. 253-960-360

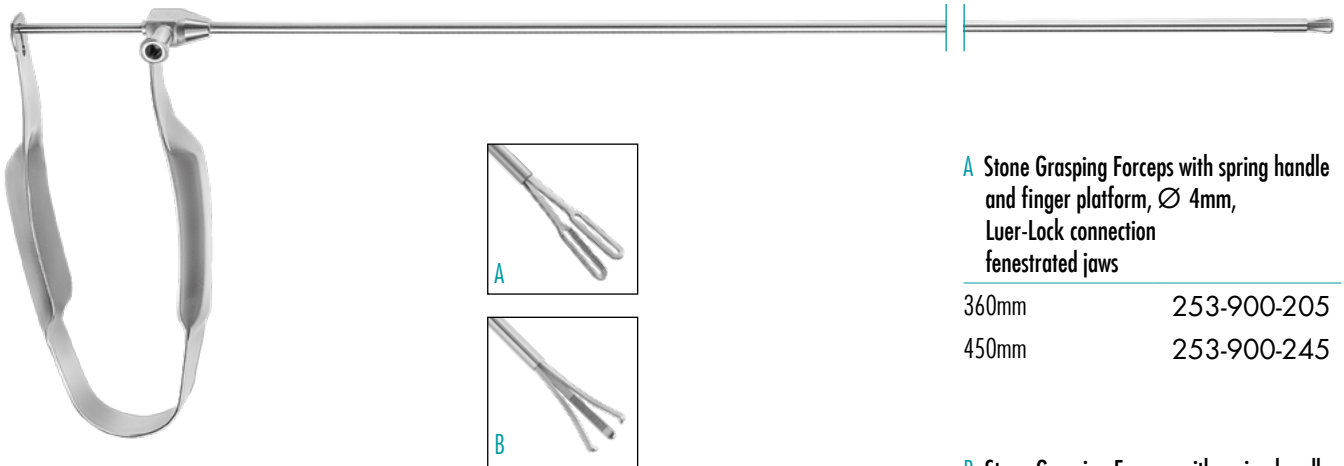

**A** Stone Grasping Forceps with spring handle and finger platform, Ø 4mm, Luer-Lock connection fenestrated jaws

360mm 253-900-205

450mm 253-900-245

**B** Stone Grasping Forceps with spring handle and finger platform, Ø 4mm, Luer-Lock connection, 3 prongs

360mm 253-900-206

450mm 253-900-246





