

CHAPTER	PAGE
INSTRUMENT SETS	4-14
SCISSORS	15-58
FORCEPS	59-68
MONOPOLAR FORCEPS	69-72
BIPOLAR NON-STICK FORCEPS	73-76
FORCEPS & CLAMPS	77-80
NEEDLE HOLDERS	81-90
WOUND RETRACTORS	91-102
NASAL RASPS	103-110
CHISELS & OSTEOTOMES	111-120
RHINOPLASTIC SET	121-124
MALLETS	125-126
NASAL SPECULA	127-144
NASAL INSTRUMENTS	145-154
DERMATOLOGY INSTRUMENTS	155-168
CLEFT PALATE INSTRUMENTS	169-172
SHAPERS	173-182
ENDOSCOPIC INSTRUMENTS	183-188
RETRACTORS & DISSECTORS	189-214
MARKERS & CALIPERS	215-220
SUCTION INSTRUMENTS	221-238
DEVICES & ACCESSORIES	239-249
INDEX	250-268

260-990-001 ABDOMINOPERINEAL RESECTION SET

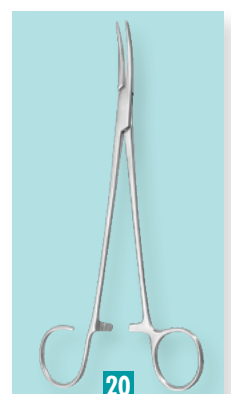
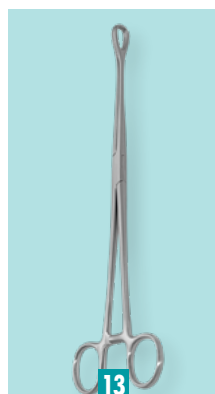
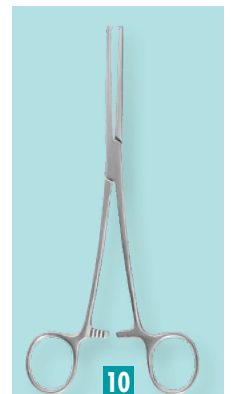
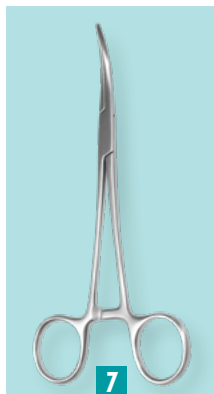
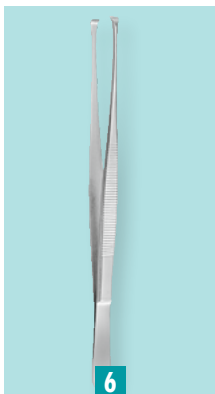
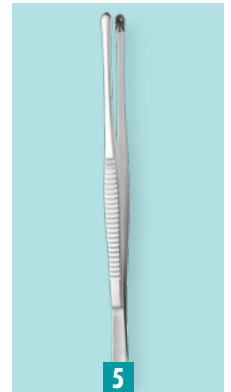
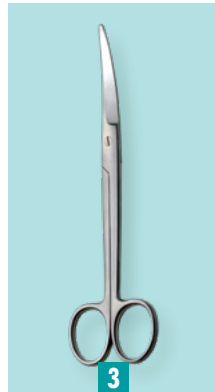

260-990-001 ABDOMINOPERINEAL RESECTION SET

Picture	Order number	Quantity	Description
1	120-030-170	2 x	Mayo Operating Scissors, straight, 170mm, 6 ² / ₃ "
2	120-031-170	2 x	Mayo Operating Scissors, curved, 170mm, 6 ² / ₃ "
3	120-031-230	2 x	Mayo Operating Scissors, curved, 230mm, 9"
4	120-111-180	2 x	Metzenbaum-Nelson Scissors, Fig. 1, curved, blunt/blunt, 180mm, 7"
5	130-510-250	1 x	Russian Tissue Forceps, 250mm, 10"
6	130-562-230	2 x	Nelson Tissue Forceps, Lung Dissecting Forceps, 230mm, 9"
7	140-291-140	10 x	Crile Hemostatic Forceps, curved, serrated, 140mm, 5 ¹ / ₂ "
8	140-295-160	6 x	Crile-Rankin Hemostatic Forceps, curved, 160mm, 6 ¹ / ₄ "
9	140-331-200	2 x	Rochester-Pean Hemostatic Forceps, curved, 200mm, 8"
10	140-332-200	6 x	Kocher-Ochsner Hemostatic Forceps, straight, 1x2 teeth, 200mm, 8"
11	140-361-280	3 x	Gemini Dissecting Forceps, 280mm, 11"
12	140-573-130	6 x	Backhaus Towel Forceps, 130mm, 5 ¹ / ₈ "
13	150-052-250	2 x	Foerster Swab Forceps, straight, serrated, 250mm, 10"
14	180-540-180	2 x	Crile-Wood TC Needle Holder, straight, serrated, 180mm, 7"
15	180-562-270	1 x	Wangensteen TC Needle Holder, 270mm, 10 ² / ₃ "
16	170-220-004	1 x	Israel Retractor, 40 x 40mm, 4 prongs, blunt, 250mm, 10"
17	170-220-006	1 x	Israel Retractor, 50 x 60 mm, 6 prongs, blunt, 250mm, 10"
18	170-227-215	2 x	Volkman Retractor, blunt, 4 prongs, 9 x 19mm, 215mm, 8 ¹ / ₂ "
19	310-014-150	12 x	Allis Tissue Forceps, 5 x 6 teeth, 150mm, 6"
20	140-630-190	8 x	Schmidt Tonsil Seizing Forceps, slightly curved, with one open ring, 185mm, 7 ¹ / ₄ "

260-990-002 BREAST SURGERY SET

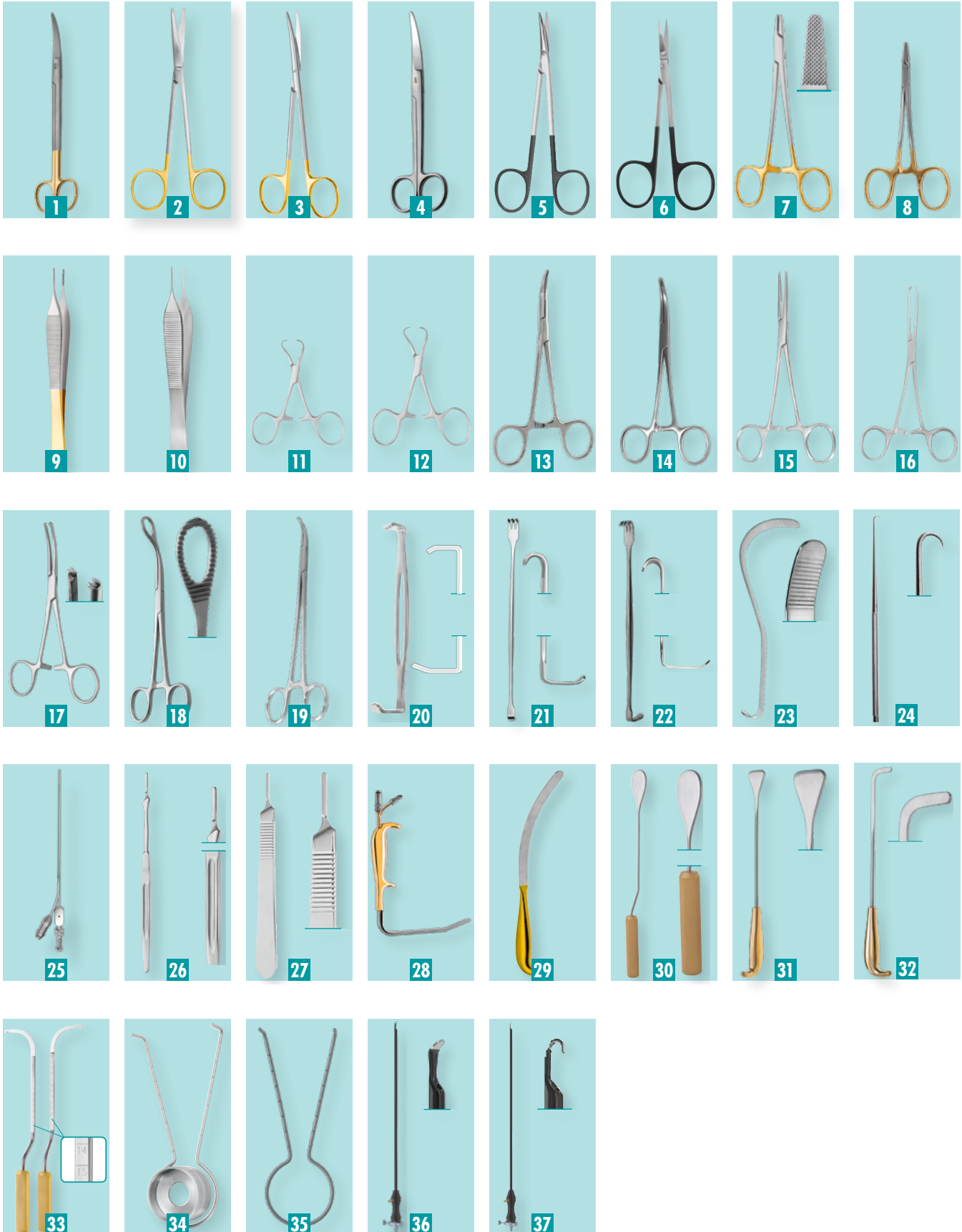

260-990-002 BREAST SURGERY SET

Picture	Order number	Quantity	Description
1	120-507-225	1 x	Bostwick-Mayo TC Scissors, curved, serrated, blunt bevelled tip, 225mm, 9"
2	120-510-145	1 x	Metzenbaum TC Scissors, Fig. 1, straight, blunt/blunt, 145mm, 5 ^{3/4} "
3	120-511-145	1 x	Metzenbaum TC Scissors, Fig. 1, curved, blunt/blunt, 145mm, 5 ^{3/4} "
4	120-031-170	1 x	Mayo Operating Scissors, curved, 170mm, 6 ^{2/3} "
5	121-095-115	1 x	Strabismus Super-Cut Scissors, curved, 115mm, 4 ^{1/2} "
6	121-075-105	1 x	Iris Super-Cut Scissors, curved, sharp/sharp, 105mm, 4 ^{1/8} "
7	180-550-160	2 x	Mayo Hegar TC Needle Holder, straight, serrated, 160mm, 6 ^{1/4} "
8	180-530-120	2 x	Webster TC Needle Holder, smooth, 115mm, 4 ^{1/2} "
9	130-529-120	2 x	Adson-Brown TC Forceps, 7x7 teeth, 2mm tooth line, tying platform, 120mm, 4 ^{3/4} "
10	130-140-120	1 x	Adson Tissue Forceps, 1x2 teeth, 120mm, 4 ^{3/4} "
11	140-573-090	2 x	Backhaus Towel Forceps, 90mm, 3 ^{1/2} "
12	140-573-110	2 x	Backhaus Towel Forceps, 110mm, 4 ^{1/2} "
13	140-255-125	6 x	Halsted-Mosquito Hemostatic Forceps, curved, 125mm, 5"
14	140-293-140	4 x	Crile Hemostatic Forceps, 1x2 teeth, curved, 140mm, 5 ^{1/2} "
15	140-281-140	2 x	Kelly Hemostatic Forceps, curved, 140mm, 5 ^{1/2} "
16	310-012-150	4 x	Allis Tissue Forceps, 4x5 teeth, 150mm, 6"
17	140-333-140	2 x	Kocher-Ochsner Hemostatic Forceps, 1x2 teeth, curved, 140mm, 5 ^{1/2} "
18	150-055-250	3 x	Foerster Swab Forceps, curved, serrated, 250mm, 10"
19	140-311-185	1 x	Adson Hemostatic Forceps, curved, 185mm, 7 ^{1/4} "
20	170-687-210	1 x	US Army Parker-Langenbeck Retractor set, Fig. 1 and Fig. 2, double pair, 210mm, 8 ^{1/4} "
21	170-215-160	1 x	Senn Retractor, sharp, 6 x 13mm, 160mm, 6 ^{1/4} "
22	170-216-160	1 x	Senn Retractor, blunt, 6 x 13mm, 160mm, 6 ^{1/4} "
23	171-591-330	1 x	Deaver Retractor, serrated, 5mm wide, 330mm, 13"
24	420-183-150	2 x	Joseph Rhinoplastic Hook, 1 Hook, 150mm, 6"
25	165-522-130	1 x	Frazier Suction Tube, straight, with fibre-optic, 10 Fr., WL 130mm, 5 ^{1/8} "
26	110-130-077	1 x	Scalpel Handle No. 7, 165mm, 6 ^{1/2} "
27	110-110-003	2 x	Scalpel Handle No. 3, 130mm, 5 ^{1/8} "
28	260-150-125	1 x	Breast Retractor, with fibre-optic and suction, 150x25mm, 180mm, 7"
29	260-400-315	1 x	Breast Spatula, semi-malleable, serrated, 150x25mm, 315mm, 12 ^{1/3} "
30	260-016-410	1 x	MacCollum-Dingman Breast Dissector, angled shaft, 410mm, 16"
31	260-011-000	1 x	Sculpo Breast Spatula Dissector, 330mm, 13"
32	260-010-000	1 x	Sculpo Breast Dissector, angled, 330mm, 13"
33	260-088-370	1 x	Agris-Dingman Transaxillary Dissector, set for creation of submammary pockets, with scale, 360mm, 14"
34	260-750-138	1 x	Freeman Areola Marker, Ø 38 mm
34	260-750-142	1 x	Freeman Areola Marker, Ø 42 mm
34	260-750-145	1 x	Freeman Areola Marker, Ø 45 mm
35	260-738-000	1 x	McKissock Breast Caliper, Ø 38 mm
35	260-742-000	1 x	McKissock Breast Caliper, Ø 42 mm
35	260-745-000	1 x	McKissock Breast Caliper, Ø 45 mm
36	260-712-000	1 x	Spatula Electrode, straight, with suction and trumpet valve, 270mm, 10 ^{2/3} "
37	260-710-000	1 x	J-Hook Electrode, straight, with suction and trumpet valve, 270mm, 10 ^{2/3} "

260-990-003 BASIC RHINOPLASTY SET

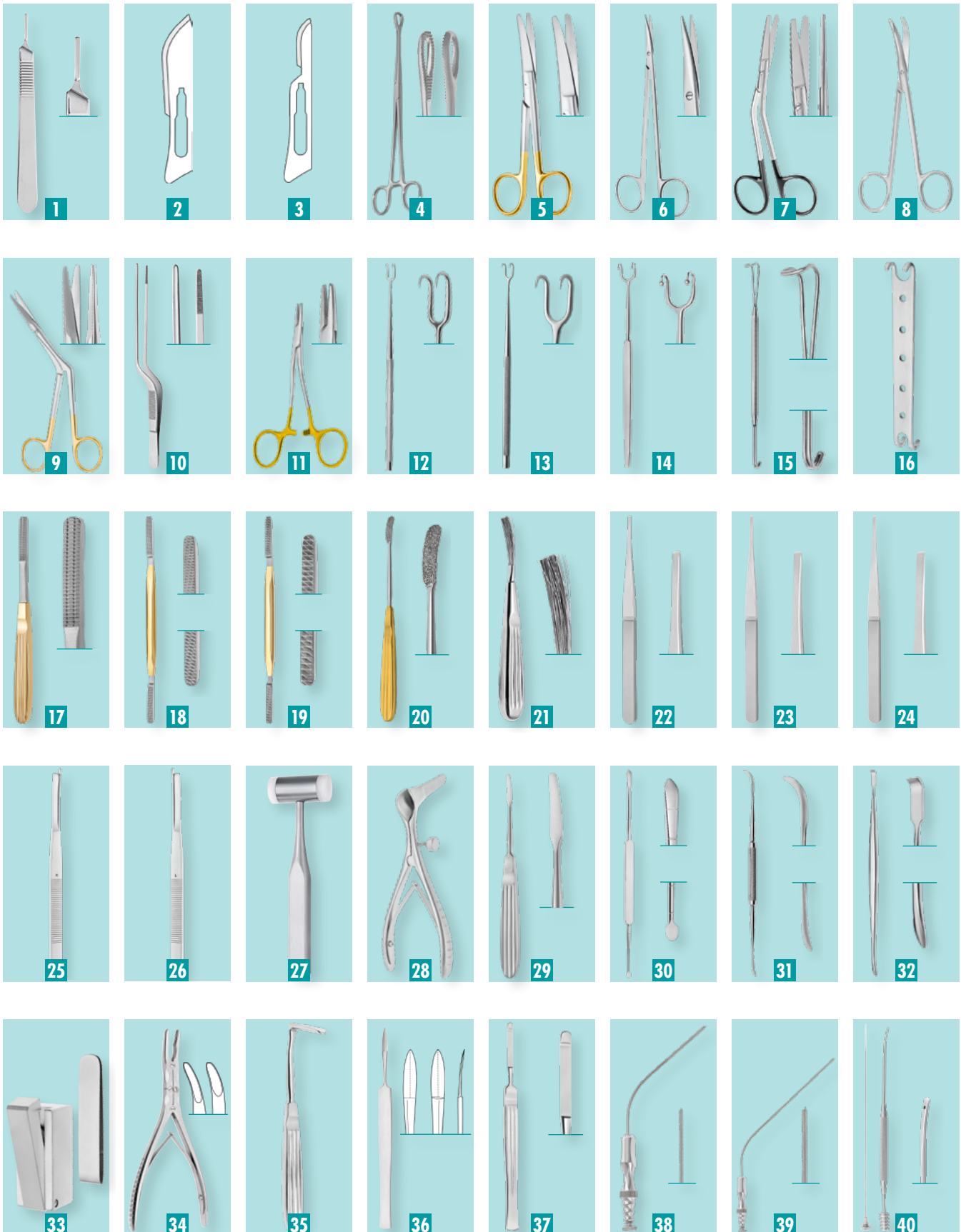

260-990-003 BASIC RHINOPLASTY SET

Picture	Order number	Quantity	Description
1	110-110-003	2 x	Scalpel Handle No. 3, 130mm, 5 ¹ / ₈ "
2	110-201-010	1 x	Scalpel blades Fig. 10, sterile, 100 pieces
3	110-201-015	1 x	Scalpel blades Fig. 15, sterile, 100 pieces
4	150-052-250	4 x	Foerster Swab Forceps, straight, serrated, 250mm, 10"
5	120-507-145	1 x	Mayo TC Operating Scissors, curved, 145mm, 5 ³ / ₄ "
6	120-121-150	1 x	Nerve Dissecting Scissors, curved, sharp, 150mm, 6"
7	121-280-145	1 x	Fomon Super-Cut Dorsal Scissors, straight, 145mm, 5 ³ / ₄ "
8	120-131-135	1 x	Fomon Dissecting Scissors, strongly curved, 135mm, 5 ¹ / ₄ "
9	120-583-180	1 x	Heymann TC Nasal Scissors, one serrated blade, 180mm, 7"
10	410-395-190	1 x	Jansen Nasal Dressing Forceps, bayonet shaped, serrated, 190mm, 7 ¹ / ₂ "
11	180-525-135	2 x	Kilner TC Needle Holder, s-curved, serrated, 135mm, 5"
12	170-014-005	1 x	Joseph Hooklet, 2 prongs, 5mm, 160mm, 6 ¹ / ₄ "
13	170-014-007	1 x	Joseph Hooklet, 2 prongs, 7mm, 160mm, 6 ¹ / ₄ "
14	230-280-160	1 x	Fomon Alar Retractor, 2 prongs, blunt, buttoned, 160mm, 6 ¹ / ₄ "
15	170-036-180	1 x	Neivert Nasal Retractor, 160mm, 6 ¹ / ₄ "
16	260-501-120	1 x	Converse Allar Retractor, double-ended, blunt, 120mm, 4 ³ / ₄ "
17	420-672-000	1 x	Original Maltz TC Nasal Rasp, backward cutting, straight, 180mm, 7"
18	420-660-214	1 x	Fomon TC Rasp, double-ended, Fig. 3/4, fine/coarse, 7 x 40mm, 210mm, 8 ¹ / ₄ "
19	420-660-218	1 x	Fomon TC Rasp, double-ended, Fig. 7/8, coarse/very coarse, 7 x 40mm, 210mm, 8 ¹ / ₄ "
20	420-650-100	1 x	Peet-Cottle Nasal Rasp, curved, diamond jaws, 175mm, 7"
21	260-500-001	1 x	Wire brush, for cleaning of nasal rasps, 165mm, 6 ¹ / ₂ "
22	420-568-002	1 x	RZ Nasal Osteotome, special handle, 2mm wide, 180mm, 7"
23	420-568-004	1 x	RZ Nasal Osteotome, special handle, 4mm wide, 180mm, 7"
24	420-568-006	1 x	RZ Nasal Osteotome, special handle, 6mm wide, 180mm, 7"
25	420-459-002	1 x	Silver Cartilage Chisel, curved right, single guarded, 180mm, 7"
26	420-459-003	1 x	Silver Cartilage Chisel, curved left, single guarded, 180mm, 7"
27	210-264-140	1 x	RZ Mallet, with 2 interchangeable plastic discs, 140g, Ø 25mm, 185mm, 7 ¹ / ₄ "
28	420-138-055	1 x	Killian-Walter Nasal Speculum, aseptic joint, with locking screw, thin blades, 55mm blade length, 140mm, 5 ¹ / ₂ "
29	420-530-165	1 x	Joseph Periosteal Elevator, slightly curved, hollow handle, 2mm wide, 170mm, 6 ³ / ₄ "
30	420-550-230	1 x	Cottle Septum Elevator, double-ended, sharp/blunt, graduated, 210mm, 8 ¹ / ₄ "
31	420-532-200	1 x	Obwegeser-Freer Septum Elevator, sharp/blunt, 200mm, 8"
32	420-552-215	1 x	Howarth Elevator, double-ended, sharp/blunt, 215mm, 8 ¹ / ₄ "
33	420-365-000	1 x	Cottle Cartilage Crusher, 28mm wide, with removal clip forceps, 75mm, 3"
34	210-790-180	1 x	Beyer Bone Rongeur, curved, double action, 4mm, 180mm, 7"
35	420-250-160	1 x	Aufricht Nasal Retractor, 10 x 45mm blade, 160mm, 6 ¹ / ₄ "
36	420-191-003	1 x	Joseph Nasal Knife, curved, sharp, double-edge, 150mm, 6"
37	420-205-160	1 x	Joseph Nasal Knife, straight, button-end knife, 150mm, 6"
38	165-525-010	1 x	Fergusson Suction Canulla, finger cut-off, stylet, Luer Lock, 10 Fr., Ø 3.3mm, 180mm, 7"
39	165-525-007	1 x	Fergusson Suction Canulla, finger cut-off, stylet, Luer Lock, 7 Fr., Ø 2.3mm, 180mm, 7"
40	420-395-205	1 x	Negus Aspirating Dissector, blunt, Ø 6mm, 205mm, 8"

260-990-004 BLEPHAROPLASTY SET

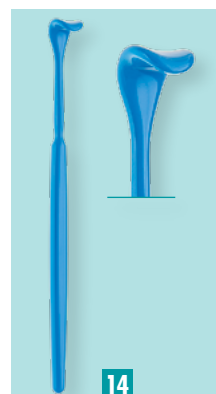
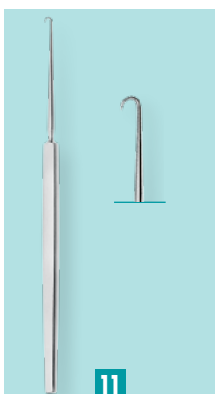
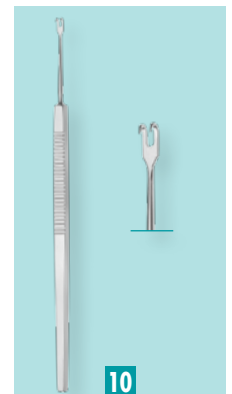
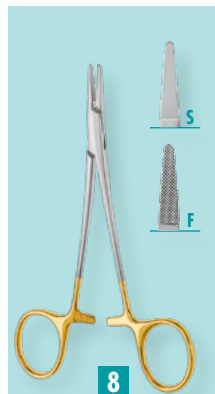
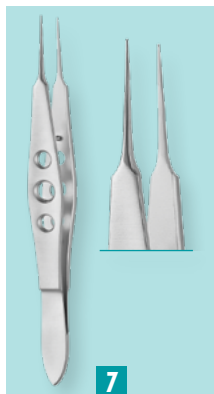
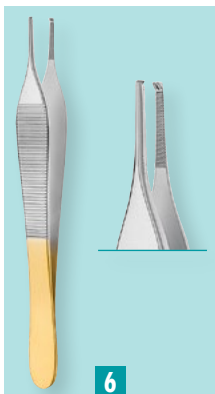
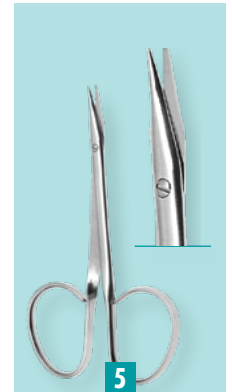
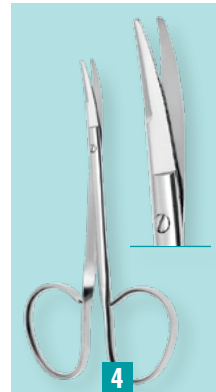
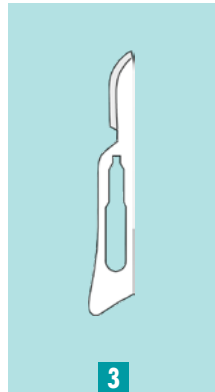
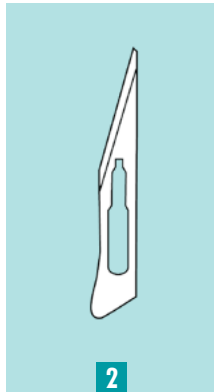

260-990-004 BLEPHAROPLASTY SET

Picture	Order number	Quantity	Description
1	110-110-003	2 x	Scalpel Handle No.3, 130mm, 5 ^{1/8} "
2	110-201-011	1 x	Scalpel blades Fig.11, sterile, 100 pieces
3	110-201-015	1 x	Scalpel blades Fig.15, sterile, 100 pieces
4	120-135-115	1 x	Kaye Blepharoplasty Scissors, curved, serrated, Ribbon handle, 115mm, 4 ^{1/2} "
5	120-091-095	1 x	Walton Tenotomy Scissors, curved, sharp, Ribbon handle, 100mm, 4"
6	130-534-120	1 x	Adson TC Tissue Forceps, 1x2 teeth, 120mm, 4 ^{3/4} "
7	400-137-030	1 x	Castroviejo Suturing Forceps, straight, 1x2 teeth, 0.3mm, with tying platform, hole handle, 110mm, 4 ^{1/3} "
8	180-536-130	1 x	Halsey TC Needle Holder, smooth, 130mm, 5"
9	180-532-120	1 x	Derf TC Needle Holder, straight, serrated, 120mm, 4 ^{3/4} "
10	170-042-160	2 x	Guthrie Wound Retractor, Fig. 1, 2 prongs, sharp, 160mm, 6 ^{1/4} "
11	170-015-140	2 x	Cushing Fine Wound Retractor, 140mm, 5 ^{1/2} "
12	400-602-267	1 x	Container for ophthalmology, with silicon mat, with 2 layers, 267 x 159 x 35mm
13	400-850-255	1 x	Cox Ocular Shield incl. Suction Cup, medium, 25.5x22mm
14	170-512-160	1 x	Desmarres Retractor, insulated, 12mm, 160mm, 6 ^{1/4} "
15	130-750-150	1 x	Micro Adson Monopolar Forceps, 1x2 teeth, insulated, 150mm, 6"

260-990-005 ENDOSCOPIC FACELIFT-FOREHEAD SET

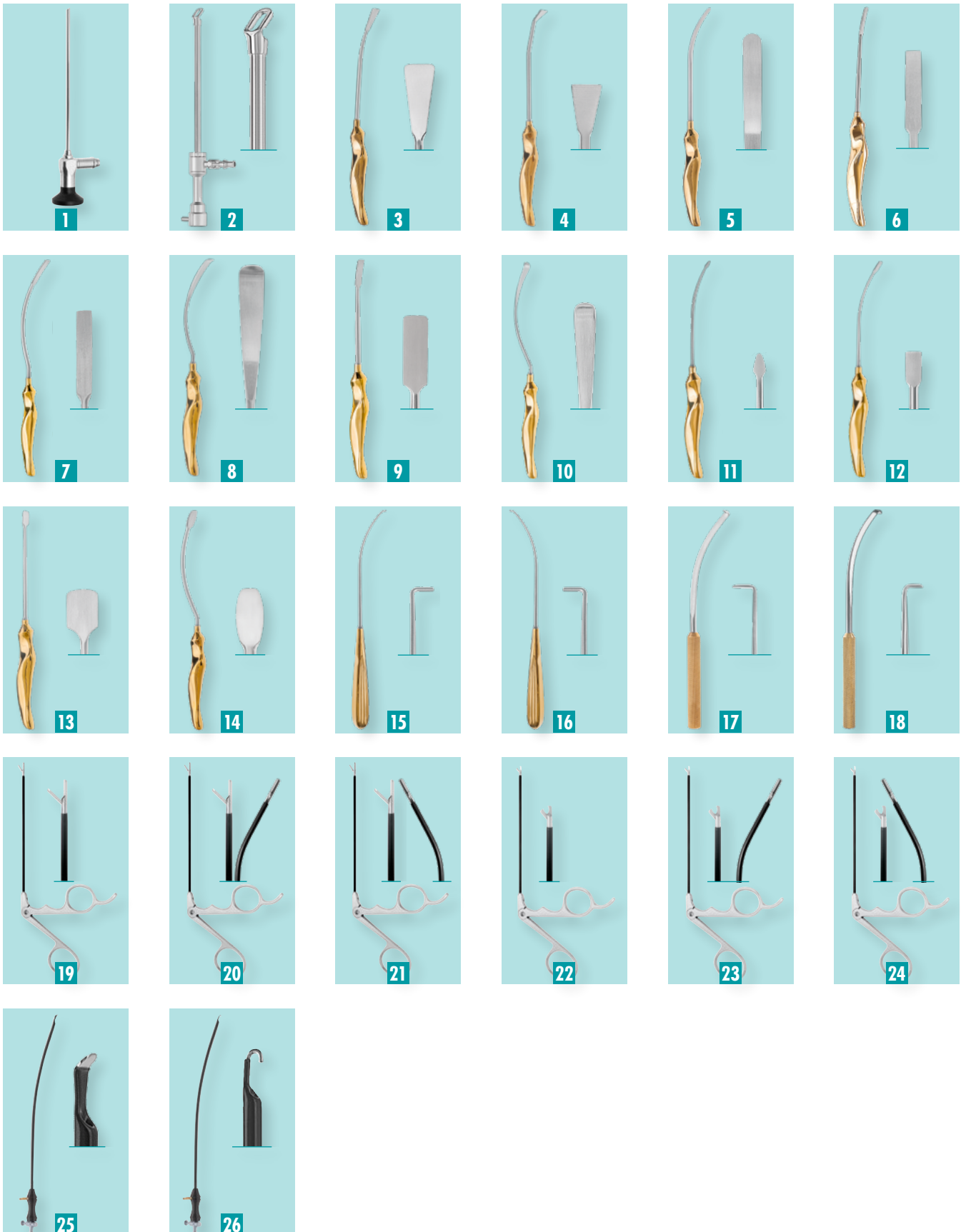

260-990-005 ENDOSCOPIC FACELIFT-FOREHEAD SET

Picture	Order number	Quantity	Description
1	260-104-030	1 x	SHAPER Telescope for Plastic Endoscopy, 30° wide angle, Ø 4mm, WL 175mm, 6 ⁷ / ₈ "
2	260-501-180	1 x	SHAPER Sheath, angled spatula tip, with rotating stopcock, Ø 4mm, 180mm, 7"
3	260-001-001	1 x	SHAPER Scalp Elevator, slightly curved, 12.5mm wide, with Ergo Handle, 240mm, 9 ¹ / ₂ "
4	260-001-002	1 x	SHAPER Scalp Elevator, medium curved, 12.5mm wide, with Ergo Handle, 240mm, 9 ¹ / ₂ "
5	260-002-001	1 x	SHAPER Endoforehead Elevator, curved, 7mm wide, with Ergo Handle, 240mm, 9 ¹ / ₂ "
6	260-020-001	1 x	SHAPER Frontotemporal Dissector, curved, 9 ¹ / ₂ inch, 6.5mm wide, with Ergo Handle, WL 240mm, 9 ¹ / ₂ "
7	260-023-000	1 x	SHAPER Frontoglabellar Dissector, s-shaped, 7mm wide, with Ergo Handle, 265mm, 10 ¹ / ₂ "
8	260-024-000	1 x	SHAPER Arcus Marginalis Dissector, s-shaped, 10mm wide, with Ergo Handle, 240mm, 9 ¹ / ₂ "
9	260-020-000	1 x	SHAPER Frontotemporal Dissector, straight, 10mm wide, with Ergo Handle, 225mm, 8 ⁷ / ₈ "
10	260-025-000	1 x	SHAPER Periosteal Dissector, s-shaped, 5mm wide, with Ergo Handle, 240mm, 9 ¹ / ₂ "
11	260-003-001	1 x	SHAPER Nerve Dissector, slightly curved, with Ergo Handle, 240mm, 9 ¹ / ₂ "
12	260-004-001	1 x	SHAPER Orbital Rim Dissector, medium curved, with Ergo Handle, 240mm, 9 ¹ / ₂ "
13	260-022-000	1 x	SHAPER Temporal Dissector, straight, with Ergo Handle, 235mm, 9 ¹ / ₄ "
14	260-021-000	1 x	SHAPER Parietal Periosteal Elevator, curved, with Ergo Handle, 250mm, 10"
15	260-003-002	1 x	SHAPER Nerve Hook, right curved, 240mm, 9 ¹ / ₂ "
16	260-003-003	1 x	SHAPER Nerve Hook, left curved, 240mm, 9 ¹ / ₂ "
17	260-008-003	1 x	SHAPER Nerve Protector, right curved, 170mm, 6 ² / ₃ "
18	260-008-002	1 x	SHAPER Nerve Protector, left curved, 170mm, 6 ² / ₃ "
19	260-204-600	1 x	SHAPER Grasping Forceps, straight, short strong jaw, insulated shaft, Ø 2.7mm, WL 125mm, 5"
20	260-204-400	1 x	SHAPER Grasping Forceps, right curved, short strong jaw, insulated shaft, Ø 2.7mm, WL 125mm, 5"
21	260-204-300	1 x	SHAPER Grasping Forceps, left curved, short strong jaw, insulated shaft, Ø 2.7mm, WL 125mm, 5"
22	260-203-600	1 x	SHAPER Hook Scissors, straight, insulated shaft, Ø 2.7mm, WL 125mm, 5"
23	260-203-700	1 x	SHAPER Hook Scissors, right curved, insulated shaft, Ø 2.7mm, WL 125mm, 5"
24	260-203-800	1 x	SHAPER Hook Scissors, left curved, insulated shaft, Ø 3.4mm, WL 125mm, 5"
25	260-702-000	1 x	Spatula Electrode, curved, with suction and trumpet valve, 270mm, 10 ² / ₃ "
26	260-700-000	1 x	J-Hook Electrode, curved, with suction and trumpet valve, 270mm, 10 ² / ₃ "

SCISSORS

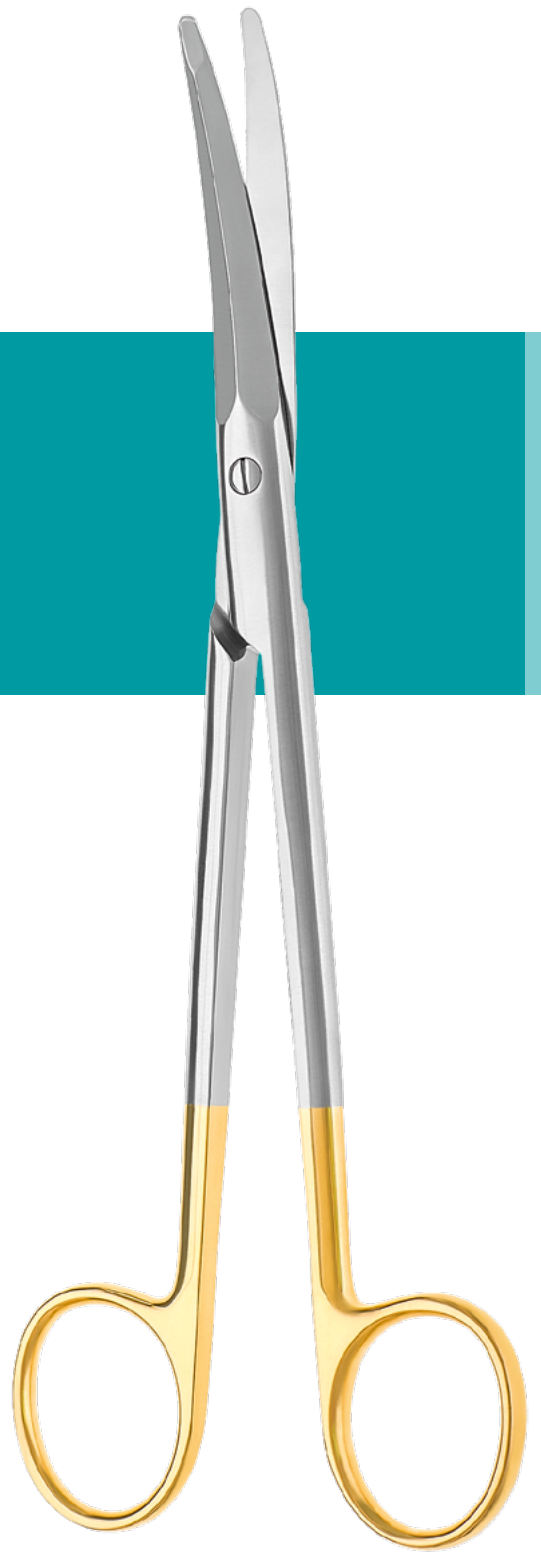

Standard Scissors

- Reliable high quality scissors with standard characteristics
- Matt finished surface



Tungsten Carbide (TC) Scissors

- Welded Tungsten Carbide inserts
- Long-lasting cutting edges
- Suitable for harder materials
- Matt finished surface
- Gold plated rings



Super-Cut (SC) Scissors

- Unique with razor-sharp edge to cut smoothly through tissue
- Lower blade with very fine serrations preventing tissue slippage
- Mirror finished surface
- Black coated rings



CeraCut® Scissors

- Very high corrosion and rust resistance
- Significant extended durability
- Lower blade with very fine serrations preventing tissue slippage
- Non-reflective surface
- Harder surface
- Razor-sharp edges
- Black ceramic coating



Tungsten Carbide (TC) Super-Cut (SC) Scissors

- Combines the advantages of TC Scissors with the outstanding cutting performance of Super-Cut Scissors
- Lower blade with very fine serrations to prevent tissue slippage
- Matt finish surface with bead-blasted shanks
- Gold plated rings



Tungsten Carbide (TC) CeraCut® Scissors

- Harder surface, combined with welded TC inserts
- Combines the advantages of TC Scissors with the excellent features of CERA-CUT Scissors
- Lower blade with very fine serrations to prevent tissue slippage
- Black ceramic coating
- Gold plated rings

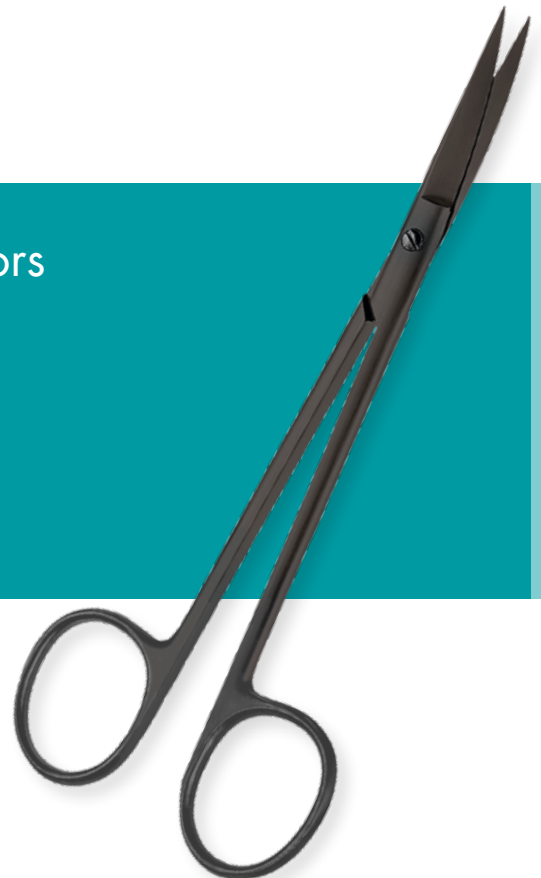



Straight

190mm, 7 1/2"

121-336-190

Curved

121-337-185

GORNEY
Super-Cut Facelift Scissors
with bevelled blades



Straight

190mm, 7 1/2"

120-586-190

Curved

120-587-190

GORNEY
TC Facelift Scissors
with bevelled blades



Straight

190mm, 7 1/2"

121-334-190

Curved

121-335-190

RZ-GORNEY
Super-Cut Facelift Scissors
with bevelled blades



230mm, 9"

121-334-230

121-335-230



	170mm, 6 3/4"	190mm, 7 1/2"	230mm, 9"
Straight	120-584-170	120-584-190	120-584-230
Curved	120-585-170	120-585-190	120-585-230

RZ-GORNEY

TC Facelift Scissors
with bevelled blades



	190mm, 7 1/2"
Straight	123-584-190
Curved	123-585-190

RZ-GORNEY

CeraCut® Facelift Scissors
with bevelled blades



Straight
Curved

190mm, 7 1/2"

121-342-190

121-343-190

GORNEY-FREEMAN
Super-Cut Facelift Scissors
with bevelled blades

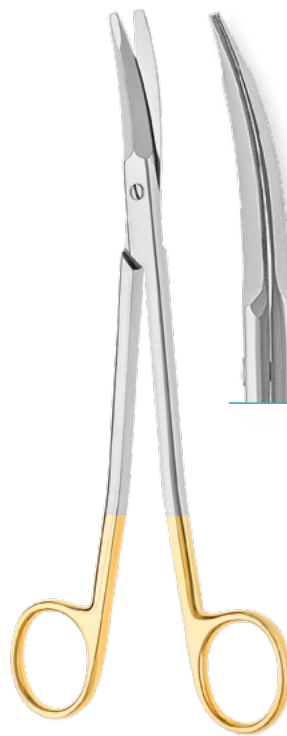

Straight
Curved

190mm, 7 1/2"

120-568-190

120-569-190

GORNEY-FREEMAN
TC Facelift Scissors
with bevelled blades



Straight
Curved

170mm, 6 3/4"

121-344-170

121-345-170

RZ-GORNEY-FREEMAN
Super-Cut Facelift Scissors
with bevelled blades



190mm, 7 1/2"

121-344-190

121-345-190



230mm, 9"

121-344-230

121-345-230



170mm, 6 3/4"

Straight

120-572-170



190mm, 7 1/2"

120-572-190



230mm, 9"

120-572-230

Curved

120-573-170

120-573-190

120-573-230

RZ-GORNEY-FREEMAN

TC Facelift Scissors
with bevelled blades

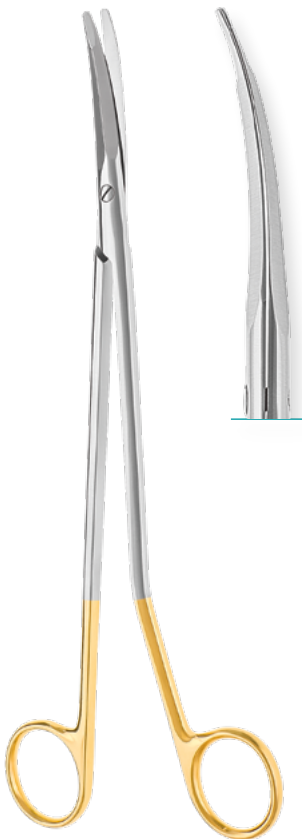

230mm, 9"

Curved

120-576-230



205mm, 8"

Curved

120-573-205

GORNEY-FREEMAN

TC Facelift Scissors, double angled shanks
with bevelled blades

METZENBAUM-FREEMAN

TC SMAS Platysma Facelift Scissors, delicate



KAYE
Super-Cut Facelift Scissors

	145mm, 5 ³ / ₄ "	180mm, 7"
Straight	121-326-145	121-326-180
Curved	121-327-145	121-327-180



KAYE
TC Facelift Scissors

	145mm, 5 ³ / ₄ "	180mm, 7"
Straight	120-570-145	120-570-180
Curved	120-571-145	120-571-180



RZ-KAYE
Super-Cut Facelift Scissors

	170mm, 6 3/4"	190mm, 7 1/2"	230mm, 9"
Straight	121-310-170	121-310-190	121-310-230
Curved	121-311-170	121-311-190	121-311-230



RZ-KAYE
TC Facelift Scissors

	170mm, 6 3/4"	190mm, 7 1/2"	230mm, 9"
Straight	120-528-170	120-528-190	120-528-230
Curved	120-529-170	120-529-190	120-529-230



Curved

190mm, 7 1/2"

123-311-190



straight shanks

Regular



splayed shanks

Freeman

RZ-KAYE
CeraCut® Facelift Scissors



Straight

180mm, 7"

121-328-180

Curved

121-329-180



Straight

180mm, 7"

120-310-180

Curved

120-311-180



RZ-KAYE-FREEMAN
Super-Cut Facelift Scissors

KAYE-FREEMAN
TC Facelift Scissors



Curved

180mm, 7"

122-311-180

KAYE-FREEMAN

TC Super-Cut Facelift Scissors
with one serrated blade



Curved

170mm, 6 3/4"

121-077-170

190mm, 7 1/2"

121-077-205

REES

Super-Cut Facelift Scissors, bevelled blade



	170mm, 6 ³ / ₄ "	190mm, 7 ¹ / ₂ "
Straight	120-576-170	120-576-190
Curved	120-577-170	120-577-205

REES
TC Facelift Scissors, bevelled blade



	200mm, 8"
Straight	123-300-200
Curved	123-301-200

REES
CeraCut® Facelift Scissors



	170mm, 6 ² / ₃ "
Straight	122-576-170
Curved	122-577-170

REES
TC Super-Cut Facelift Scissors

	15mm blade 180mm, 6"	25mm blade 180mm, 6"
	120-092-182	120-093-182

PADDLE
Facelift Scissors
with one serrated blade

Not for sale in the USA and Canada



	170mm, 6 3/4"	200mm, 8"
Straight	121-300-170	121-300-200
Curved	121-301-170	121-301-200

ASTON
Super-Cut Facelift Scissors



	170mm, 6 3/4"	200mm, 8"
Straight	120-500-170	
Curved	120-501-170	120-501-200

ASTON
TC Facelift Scissors



170mm, 6 3/4"

200mm, 8"

Straight

121-304-170

121-304-200

Curved

121-305-170

121-305-200

MATARASSO

Super-Cut Facelift Scissors



170mm, 6 3/4"

200mm, 8"

Curved

123-305-170

123-305-200

MATARASSO

TC CeraCut® Facelift Scissors



Curved



180mm, 7"

121-211-180



200mm, 8"

121-211-200



230mm, 9"

121-211-230

METZENBAUM-FREEMAN

Super-Cut Facelift Scissors with bevelled blades



Curved



225mm, 9"

123-505-225

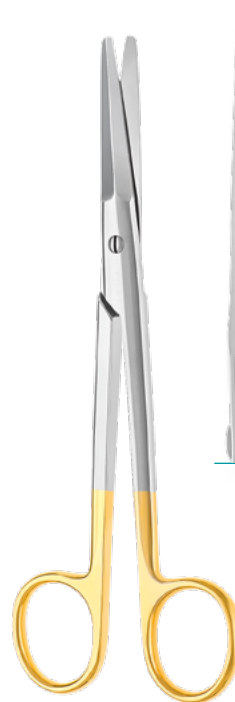

Straight



170mm, 6²/₃"

120-574-170

KLAPPER

TC CeraCut® Facelift Scissors with bevelled blades

TESSIER

TC Facelift Scissors



Curved

145mm, 5³/₄"

121-575-145

AUFRICHT
Super-Cut Facelift Scissors



Curved

145mm, 5³/₄"

120-575-145

AUFRICHT
TC Facelift Scissors



150mm, 6"

200mm, 8"

Kaye pattern

121-214-150

121-214-200

BOETTLER (Kaye pattern)
Super-Cut Facelift Scissors, reinforced,
round shanks on the tip



200mm, 8"

Sims pattern

121-204-200

BOETTLER (Sims pattern)
Super-Cut Facelift Scissors, reinforced,
round shanks on the tip





Straight

150mm, 6"
120-338-150

CASTANARES
Facelift Scissors, square blades



Straight

150mm, 6"

121-312-150

Curved

121-313-150

CASTANARES
Super-Cut Facelift Scissors



Straight

150mm, 6"
120-538-150

CASTANARES
TC Facelift Scissors



Straight

150mm, 6"

123-312-150

Curved

123-313-150

CASTANARES
CeraCut® Facelift Scissors



Curved

135mm, 5¹/₃"

121-139-135

FOMON-SABER
Super-Cut Facelift Scissors



Curved

145mm, 5³/₄"

121-137-145

KAHN
Super-Cut Facelift Scissors



Curved

140mm, 5¹/₂"

120-591-140

GREGORY
TC Facelift Scissors, slightly curved,
slightly bevelled blade



Curved

180mm, 7"

120-595-180

STELLA
Super-Cut Facelift Scissors, S-curved,
slightly bevelled blade





Curved

180mm, 7"
120-173-180

DAVIS
Facelift Scissors



Curved

180mm, 7"
121-313-170

RZ-DAVIS
Super-Cut Facelift Scissors

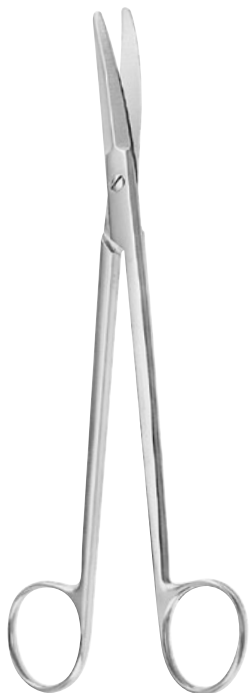

Curved

180mm, 7"
120-209-180

BOETTCHER
Facelift Scissors



Curved

180mm, 7"
121-209-180

BOETTCHER
Super-Cut Facelift Scissors





GOLDMAN-FOX

Gum Scissors, one serrated blade, 130mm, 5¹/₈"

Straight	120-666-130
----------	-------------

Curved	120-667-130
--------	-------------



GOLDMAN-FOX

TC Scissors, one serrated blade, 130mm, 5¹/₈"

Straight	120-966-130
----------	-------------

Curved	120-967-130
--------	-------------



KAYE SUPER-CUT

Blepharoplasty Scissors, 115mm, 4¹/₂"

Curved	121-316-115
--------	-------------



PAR TYPE

Super-Cut Scissors

Straight, 110mm, 4 ¹ / ₃ "	121-330-110
--	-------------

Curved, 110mm, 4 ¹ / ₃ "	121-331-110
--	-------------

Curved, 150mm, 6"	121-331-150
-------------------	-------------



KAYE

TC Blepharoplasty Scissors, serrated, 115mm, 4¹/₂"

Curved	120-571-115
--------	-------------

Straight	120-323-110
----------	-------------

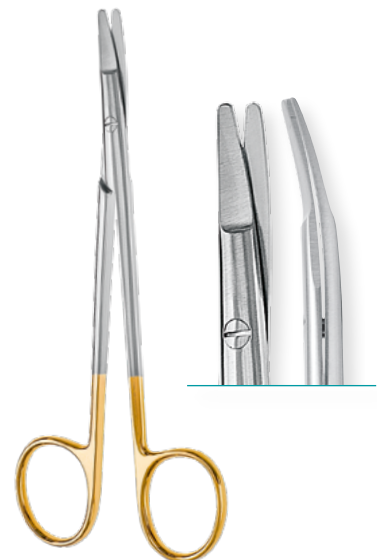

PAR XL

TC Blepharoplasty Scissors, 135mm, 5¹/₃"

Curved	121-316-115
--------	-------------



STEVENS
Tenotomy Scissors, blunt, 105mm, 4¹/₈"

Straight	120-092-105
Curved	120-093-105



STEVENS
Tenotomy Scissors, blunt, 115mm, 4¹/₂"

Straight	120-092-115
Curved	120-093-115



STEVENS
Tenotomy Scissors, blunt, 125mm, 5"

Straight	120-092-125
Curved	120-093-125



STEVENS
TC Tenotomy Scissors, sharp, 110mm, 4¹/₃"

Straight	122-296-110
Curved	122-297-110



STEVENS
Super-Cut Tenotomy Scissors, blunt, 105mm, 4¹/₈"

Curved	121-093-105
--------	-------------



STEVENS
Super-Cut Tenotomy Scissors, blunt, 115mm, 4¹/₂"

Straight	121-196-110
Curved	121-197-110



STEVENS

CeraCut® Tenotomy Scissors, blunt, 110mm, 4¹/₃"

Straight	123-196-110
----------	-------------

Curved	123-197-110
--------	-------------



STEVENS

CeraCut® Tenotomy Scissors, blunt, 120mm, 4³/₄"

Straight	123-196-120
----------	-------------

Curved	123-197-120
--------	-------------



STEVENS

CeraCut® Tenotomy Scissors, sharp, 150mm, 6"

Sharp	123-089-150
-------	-------------

Blunt	123-197-150
-------	-------------



JAMESON

Tenotomy Scissors, curved

150mm, 6"	120-315-150
-----------	-------------

180mm, 7"	120-315-180
-----------	-------------



JAMESON

Super-Cut Scissors, 150mm, 6"

Curved	121-315-150
--------	-------------



GREENBERG-PAR

TC Scissors, serrated, 115mm, 4¹/₂"

Curved	120-593-115
--------	-------------



STRABISMUS
Scissors, blunt, 115mm, 4¹/₂"

Straight	120-094-115
Curved	120-095-115



STRABISMUS
TC Scissors, blunt, 115mm, 4¹/₂"

Curved	123-595-115
--------	-------------



STRABISMUS
TC Super-Cut Scissors, 115mm, 4¹/₂"

Straight	122-594-115
Curved	122-595-115



STRABISMUS
TC CeraCut® Scissors, blunt, 115mm, 4¹/₂"

Curved	123-595-115
--------	-------------



STRABISMUS
Super-Cut Scissors, blunt, 115mm, 4¹/₂"

Straight	121-094-115
Curved	121-095-115



LAHEY
Scissors, 145mm, 5³/₄"

Curved	120-330-145
--------	-------------



REYNOLDS
Super-Cut Tenotomy Scissors, 125mm, 5"

Curved 121-318-125



REYNOLDS
TC CeraCut® Tenotomy Scissors, 125mm, 5"

Curved 123-518-125



RAGNELL
Undermining and Dissecting Scissors, 130mm, 5¹/₄"

Slightly curved 120-065-130



RAGNELL
SC Undermining and Dissecting Scissors, 130mm, 5¹/₄"

Slightly curved 121-065-130



RAGNELL (KILNER)
Undermining and Dissecting Scissors, curved

120mm, 4³/₄" 120-065-120

150mm, 6" 120-065-150

180mm, 7" 120-065-180

200mm, 8" 120-065-200

230mm, 9" 120-065-230



RAGNELL (KILNER)
SC Undermining and Dissecting Scissors, curved

150mm, 6" 121-332-150

180mm, 7" 121-332-180

200mm, 8" 121-332-200



IRIS
Scissors, with large rings, 100mm, 4"

Straight	120-082-100
Curved	120-083-100



IRIS
Scissors, 115mm, 4 1/2"

Straight	120-080-115
Curved	120-081-115



IRIS
Super-Cut Scissors, 110mm, 4 1/3"

Straight	121-070-110
Curved	121-071-110



IRIS
CeraCut® Scissors, 115mm, 4 1/2"

Straight	123-070-115
Curved	123-071-115



JOSEPH
Dissecting Scissors, sharp, 150mm, 6"

Curved	120-059-140
--------	-------------



JOSEPH
CeraCut® Dissecting Scissors, 145mm, 5³/₄"

Straight	123-526-145
Curved	123-527-145



BEUS-JOSEPH
Dissecting Scissors, 140mm, 5¹/₂"

S-Curved	120-283-140
----------	-------------



PECK-JOSEPH
TC Dissecting Scissors, double serrated, 140mm, 5¹/₂"

Curved	120-561-140
--------	-------------



PECK-JOSEPH
Super-Cut Dissecting Scissors, 140mm, 5¹/₂"

Straight	121-060-140
Curved	121-061-140



KELLY
Surgical Scissors, 160mm, 6^{1/4}"

Straight	120-046-160
Curved	120-047-160



SHEA
Dissecting Scissors, sharp, 120mm, 4^{3/4}"

Curved	120-141-120
--------	-------------



Nerve Dissecting Scissors
Sharp, 150mm, 6"

Straight	120-120-150
Curved	120-121-150



BONN
Scissors, extra delicate blades, 90mm, 3^{1/2}"

Curved	120-073-080
--------	-------------



SEALY
Scissors, sharp, 105mm, 4^{1/8}"

Curved	120-079-105
--------	-------------



LAGRANGE
Scissors, 1 serrated blade, 115mm, 4^{1/2}"

S-Curved	120-305-105
----------	-------------



FOMON
Lower Lateral Nasal Scissors, 110mm, 4¹/₃"

Strongly-Curved 120-131-110



FOMON
Super-Cut Lower Lateral Nasal Scissors, 110mm, 4¹/₃"

Strongly-Curved 121-131-110



FOMON
Super-Cut Lower Lateral Nasal Scissors, 125mm, 5"

Strongly-Curved 121-339-127



FOMON
Super-Cut Dorsal Scissors, 145mm, 5³/₄"

Knee bent 121-280-145



FOMON
Lower Lateral Nasal Scissors, 170mm, 6²/₃"

Strongly-Curved 120-339-170



Enderectomy Super-Cut Dissecting Scissors,
180mm, 7"

Curved 121-320-180



DANIELS
Nasal Scissors, 90mm, 3¹/₂"

40° upwards angled 120-411-090



WILMER
Utility Scissors, 100mm, 4"

Angled on flat 120-084-100



QUINTA
TC Nasal Scissors, angled shanks, serrated, 135mm, 5¹/₃"

Angled upwards 122-411-135



BEUSE
Nasal Scissors, blunt, 110mm, 4¹/₃"

Slightly-Curved 120-281-110



BEUSE
Nasal Scissors, sharp, 130mm, 5¹/₈"

Slightly-Curved 120-281-130



REES
Bulldog Scissors, 130mm, 5¹/₈"

Slightly-Curved 120-283-130



CAPLAN
Nasal Scissors, 220mm, 8²/₃"

Straight 120-286-220



GORNEY
Nasal Scissors, 220mm, 8²/₃"

Straight 120-588-220



COTTLE
Super-Cut Dorsal Scissors, 170mm, 6²/₃"

Knee bent 121-290-165



HEYMANN
TC Nasal Scissors, one serrated blade, 180mm, 7"

Straight 120-585-180



HEYMANN
TC Nasal Scissors, both blades serrated, 180mm, 7"

Straight 120-583-180



BABY-METZENBAUM
Scissors, 115mm, 4^{1/2}"

Straight	120-110-115
Curved	120-111-115



BABY-METZENBAUM
TC Scissors, 115mm, 4^{1/2}"

Straight	120-510-115
Curved	120-511-115



BABY-METZENBAUM
Super-Cut Scissors, curved

115mm, 4 ^{1/2} "	123-317-110
145mm, 5 ^{3/4} "	123-317-145



BABY-METZENBAUM
CeraCut® Scissors, curved

110mm, 4 ^{1/3} "	123-317-110
145mm, 5 ^{3/4} "	123-317-145

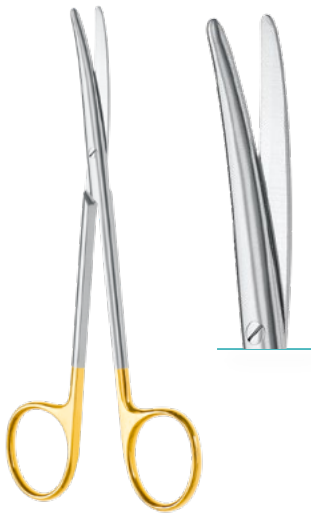

METZENBAUM
TC Dissecting Scissors

METZENBAUM
Super-Cut Dissecting Scissors, curved

	Straight	Curved
145mm, 5 ³ / ₄ "	120-510-145	120-511-145
180mm, 7"	120-510-180	120-511-180
200mm, 8"	120-510-200	120-511-200
230mm, 9"	120-510-230	120-511-230
280mm, 11"	120-510-280	120-511-280

145mm, 5 ³ / ₄ "	121-111-145
180mm, 7"	121-111-180
200mm, 8"	121-111-200
230mm, 9"	121-111-230
280mm, 11"	121-111-280



METZENBAUM
TC Dissecting Scissors, sharp

METZENBAUM
CeraCut® Dissecting Scissors, curved

	Straight	Curved
145mm, 5 ³ / ₄ "	120-514-145	120-515-145
180mm, 7"	120-514-180	120-515-180
230mm, 9"	120-514-230	

145mm, 5 ³ / ₄ "	123-111-145
180mm, 7"	123-111-180
200mm, 8"	123-111-200



METZENBAUM-FINO
TC Dissecting Scissors, 145mm, 5³/₄"

Straight	120-520-145
Curved	120-521-145



METZENBAUM-FINO
TC Dissecting Scissors, sharp, 145mm, 5³/₄"

S-Curved	120-527-145
----------	-------------



METZENBAUM-FINO
Super-Cut Dissecting Scissors, curved, blunt

145mm, 5 ³ / ₄ "	121-153-145
180mm, 7"	121-153-180
200mm, 8"	121-153-200
230mm, 9"	121-153-230



METZENBAUM-FINO
CeraCut® Dissecting Scissors, sharp, 145mm, 5³/₄"

Straight	123-152-145
Curved	123-153-145



TOENNIS-ADSON
TC Dissecting Scissors, curved

170mm, 6 ² / ₃ "	120-531-170
--	-------------



TOENNIS-ADSON
Super-Cut Dissecting Scissors, curved

170mm, 6 ² / ₃ "	121-319-170
--	-------------

Mayo Scissors



MAYO
TC Surgical Scissors

	Straight	Curved
145mm, 5 ³ / ₄ "	120-506-145	120-507-145
170mm, 6 ² / ₃ "	120-506-170	120-507-170
230mm, 9"	120-506-230	120-507-230

MAYO
CeraCut® Surgical Scissors, curved

170mm, 6 ² / ₃ "	123-031-170
--	-------------



MAYO
Super-Cut Surgical Scissors

	Straight	Curved
145mm, 5 ³ / ₄ "	121-030-145	121-031-145
170mm, 6 ¹ / ₂ "	121-030-170	121-031-170
230mm, 9"	121-030-230	121-031-230

MAYO-STILLE
CeraCut® Surgical Scissors, curved

170mm, 6 ² / ₃ "	123-037-170
--	-------------



STITCH
Removal Scissors, 100mm, 4"

Curved	120-078-100
--------	-------------



IRIS
Tenotomy Scissors, sharp, 95mm, 3³/₄"

Straight	120-080-095
Curved	120-081-095



IRIS
Tenotomy Scissors, sharp, 105mm, 4¹/₈"

Straight	120-078-105
Curved	120-083-105

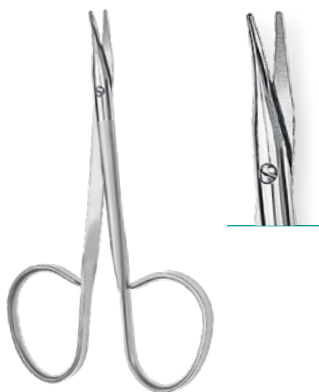

STEVENS
Tenotomy Scissors, blunt, 100mm, 4"

Straight	120-098-100
Curved	120-099-100



STEVENS
Super-Cut Tenotomy Scissors, blunt, 100mm, 4"

Straight	121-098-100
Curved	121-099-100



STEVENS
Super-Cut Tenotomy Scissors, sharp, 100mm, 4"

Curved	121-091-095
--------	-------------



WALTON
Tenotomy Scissors, sharp, 100mm, 4"

Curved	120-091-095
--------	-------------



GRADLE-WALTON
Scissors, sharp, 100mm, 4"

Straight	120-132-200
Curved	120-133-200



GRADLE-WALTON
Super-Cut Scissors, sharp, 115mm, 4¹/₂"

Straight	121-132-200
Slightly curved	121-133-200



KAYE
Blepharoplasty Scissors, serrated, 115mm, 4¹/₂"

Curved	120-135-115
--------	-------------



WALDRAM
Super-Cut Scissors, blunt, 118mm, 4^{2/3}"

Curved 121-011-125



STRABISMUS
Super-Cut Scissors, blunt, 120mm, 4^{3/4}"

Straight 121-100-120
Slightly curved 121-101-120



STEVENS
Super-Cut Tenotomy Scissors, blunt, 125mm, 5"

Curved 121-012-125



IRIS
Super-Cut Scissors, sharp, 100mm, 4"

Curved 121-081-100



JABALEY
Super-Cut Scissors, sharp, 130mm, 5^{1/8}"

Curved 121-089-130



STEVENS
Super-Cut Scissors, with splayed shanks, 120mm, 4^{1/2}"

Straight 121-296-120



STEVENS

Super-Cut Dissecting Scissors

Straight

Curved

115mm, 4¹/₂" sharp

121-182-115

121-183-115

115mm, 4¹/₂" blunt

121-184-115

121-185-115



STRABISMUS

Super-Cut Dissecting Scissors, blunt, 115mm, 4¹/₂"

Straight

121-186-115

Curved

121-187-115



REYNOLDS-JAMESON

Super-Cut Vessel Scissors, sharp, 140mm, 5¹/₂"

Straight

121-190-140

Curved

121-191-140



METZENBAUM

Super-Cut Dissecting Scissors, 145mm, 5³/₄"

Straight

121-188-145

Curved

121-189-145



RZ
TC Ligature Scissors, curved, serrated blade

115mm, 4 ¹ / ₂ "	120-611-115
140mm, 5 ¹ / ₂ "	120-611-140
180mm, 7"	120-611-180
230mm, 9"	120-611-230



SPENCER
Ligature Scissors, 90mm, 3¹/₂"

<u>Straight</u>	120-220-090
-----------------	-------------



O'BRIEN
Suture Scissors, 120mm, 4³/₄"

<u>Angled</u>	120-084-120
---------------	-------------



LITTLER
Delicate Scissors, sharp, with suture hole, 115mm, 4¹/₂"

<u>Slightly Curved</u>	120-061-115
------------------------	-------------



LITTLER
Super-Cut Delicate Scissors, sharp, with suture hole, 115mm, 4¹/₂"

<u>Slightly Curved</u>	121-061-115
------------------------	-------------



POTTS-SMITH

CeraCut® TC Vascular Scissors, 190mm, 7^{1/2}"

60° angled

123-583-190



TC UNIVERSAL

TC Wire & Plate Scissors, serrated, 120mm, 5"

Straight

120-565-120



LISTER

Bandage Scissors

140mm, 5^{1/2}"

190-165-140

180mm, 7"

190-165-180

180mm, 7" - Super-Cut

191-165-180

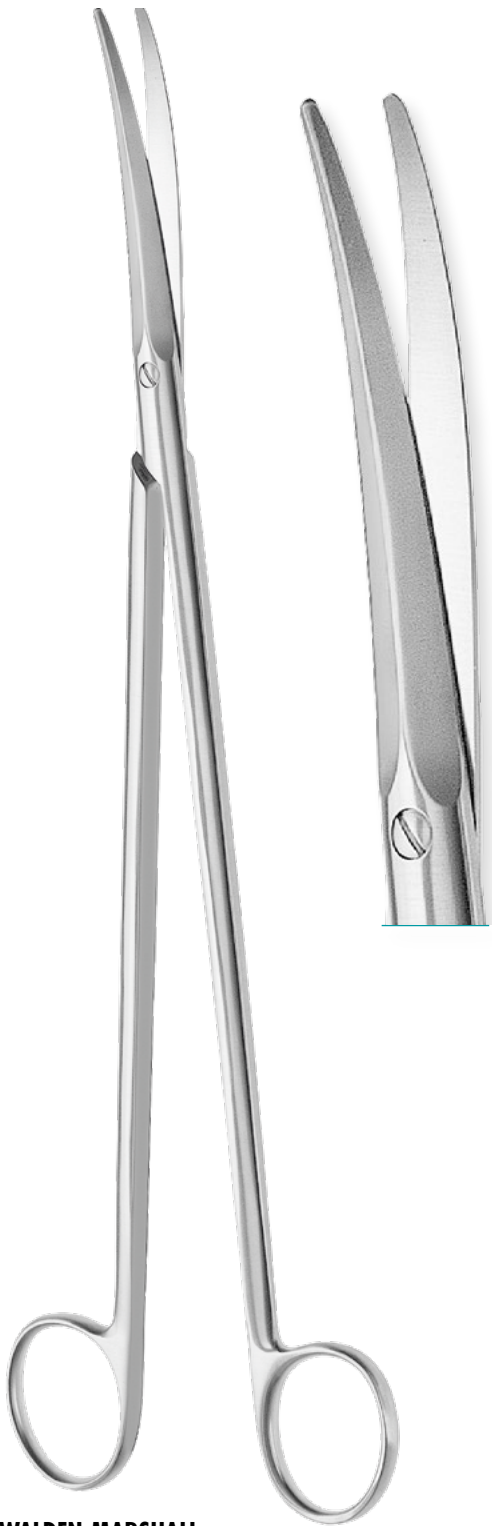

WALDEN-MARSHALL

Breast Dissecting Scissors, curved

230mm, 9"	120-580-230
250mm, 10"	120-580-250
305mm, 12"	120-580-305
355mm, 14"	120-580-355

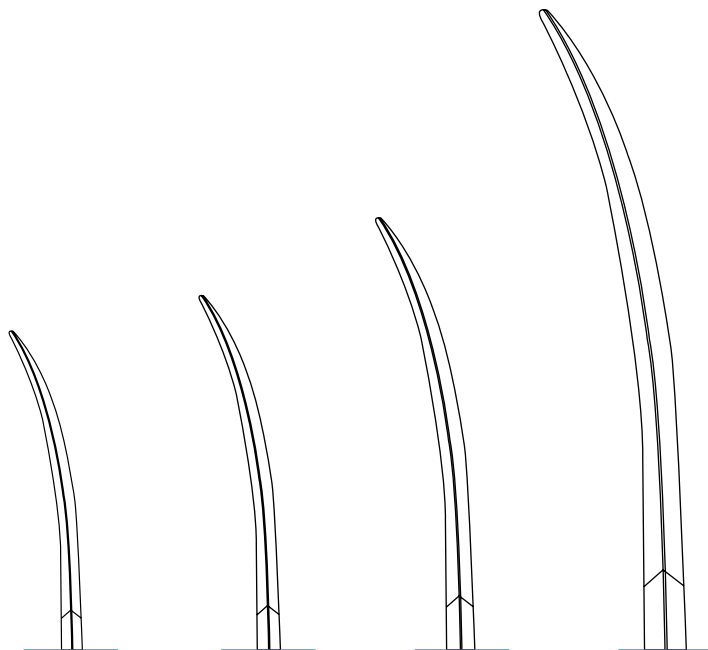

Breast dissecting scissors with double-sided cutting edges, curved. The different lengths provide adequate access when using a transaxillary approach for breast augmentation.

Endoscopic plastic surgery is essentially improved by the new and innovative RZ Face Lift Instruments. The unique handle design allows increased tactile feedback by simply rolling thumb and index finger, thus control and comfort is consequently enhanced. These versatile Instruments are designed for exact dissections of fascia, muscle and periosteum.

Malleable and insulated shafts match facial contours, introducing the temporal slit incision to dissect above the acus marginalis or cutting periosteal attachments to the superolateral orbital rim becomes a new comfort way in face lift surgery.

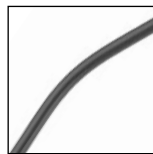

Curved right

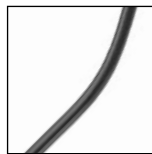

Curved left

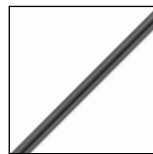

Straight

RZ Endo Face Lift Instrument with Ergo Handle, 150mm



- 260-650-150 Scissors, blade straight, shaft curved left
- 260-651-150 Scissors, blade straight, shaft curved right
- 260-652-150 Scissors, blade curved left, straight malleable shaft
- 260-663-150 Scissors, blade straight, straight malleable shaft



- 260-653-150 Spoon, straight malleable shaft
- 260-656-150 Spoon, shaft curved right
- 260-657-150 Spoon, shaft curved left



- 260-654-150 Grasping forceps, straight malleable shaft
- 260-658-150 Grasping forceps, shaft curved right
- 260-659-150 Grasping forceps, shaft curved left



- 260-655-150 Needle Holder, straight malleable shaft
- 260-660-150 Needle Holder, shaft curved right
- 260-661-150 Needle Holder, shaft curved left



FORCEPS





BISHOP-HARMON

Dressing Forceps, 0.5mm tip, 85mm, 3¹/₃"

Straight

400-018-005



RZ

Delicate Dressing Forceps, 0.7mm wide, 100mm, 4"

Straight

130-490-100

Slightly curved

130-491-100

Strongly curved

130-492-100



GRAEFE

Dressing Forceps, 100mm, 4"

Straight

130-500-100

Slightly curved

130-501-100

Strongly curved

130-502-100

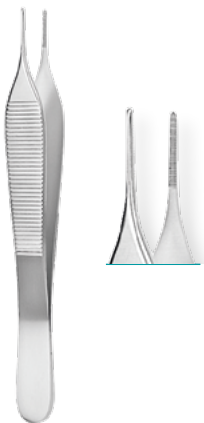

ADSON

Dressing Forceps, serrated

120mm, 4³/₄"

130-026-120

150mm, 6"

130-026-150



MICRO-ADSON

Dressing Forceps, serrated

120mm, 4³/₄"

130-548-120

150mm, 6"

130-548-150



STEVENS

Dressing Forceps, 105mm, 4¹/₈"

Slightly curved

130-511-110



LUCAE
Dressing Aural Forceps, bayonet shape, 140mm, 5¹/₂"

Serrated

410-391-140



JANSEN
Dressing Nasal Forceps, bayonet shape, 190mm, 7¹/₂"

Serrated

410-395-190

1x2 teeth

410-396-190



BISHOP-HARMON
Tissue Forceps, straight, 0.5mm tip, 85mm, 3¹/₃"

1x2 teeth

400-118-005



GRAEFE
Delicate Tissue Forceps, 1x2 teeth, 100mm, 4"

Straight

130-503-100

Slightly curved

130-504-100

Strongly curved

130-505-100

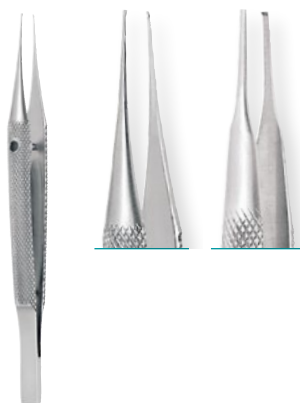

KIRBY
Fixation Forceps, straight, 100mm, 4"

1x2 teeth

400-082-100

2x3 teeth

400-083-100

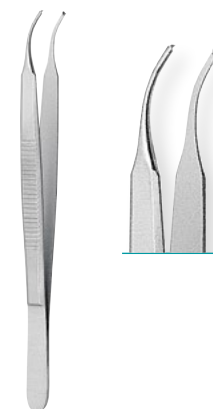

STEVENS
Tissue Forceps, 1 x 2 teeth, 110mm, 4¹/₃"

Slightly curved

130-513-110



CASTROVIEJO

Fixation Forceps, straight, 0.3mm tip, 100mm, 4"

2x2 teeth

400-022-090



CASTROVIEJO (HOLE HANDLE)

Suture Forceps, 0.9mm tip, 110mm, 4^{1/3}", tying platform

1x2 teeth

400-137-150



(0.12mm tip illustrated)

CASTROVIEJO (HOLE HANDLE)

Suture Forceps, 1x2 teeth, 110mm, 4^{1/3}", tying platform

0.12mm tip

400-137-012

0.3mm tip

400-137-030

0.5mm tip

400-137-050

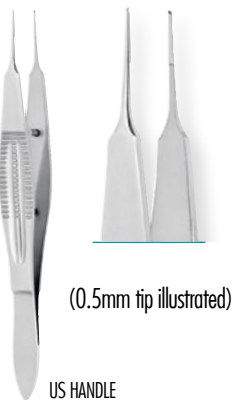

(0.5mm tip illustrated)

US HANDLE

CASTROVIEJO

Suture Forceps, 1x2 teeth, 110mm, 4^{1/3}", tying platform

0.12mm tip

400-137-021

0.3mm tip

400-137-031

0.5mm tip

400-137-055

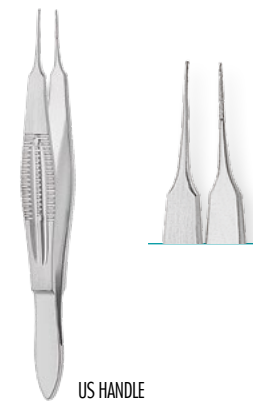

US HANDLE

CASTROVIEJO (DIAMOND DUSTED)

Suture Forceps, 1x2 teeth, 0.3mm tip, tying platform

100mm, 4"

400-137-003

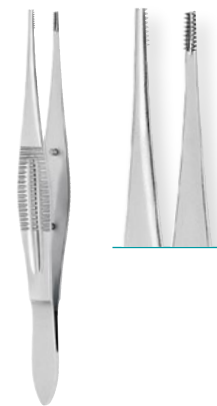

CASTROVIEJO BROWN

Tissue Forceps, straight, 110mm, 4^{1/3}"

9x9 teeth

400-139-050



ADSON

Forceps, 1x2 teeth

120mm, 4³/₄"

130-140-120

150mm, 6"

130-140-150

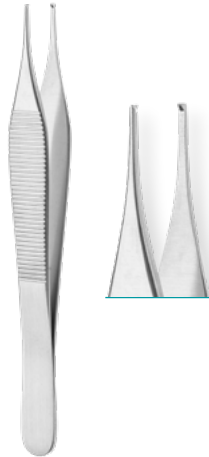

MICRO-ADSON

Forceps, 1x2 teeth

120mm, 4³/₄"

130-550-120

150mm, 6"

130-550-150

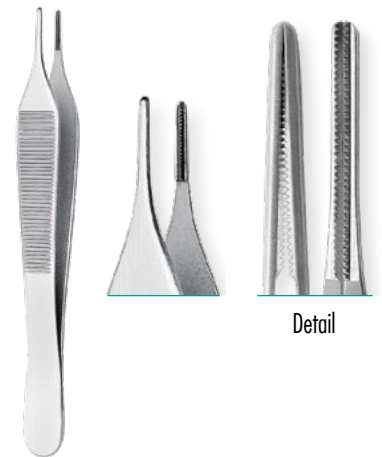

ADSON-DEBAKEY

Atraumatic Forceps, 120mm, 4³/₄"

Straight

130-527-120



GERALD

Tissue Forceps, 1x2 teeth, 180mm, 6³/₄"

Curved

130-151-180



BROWN

Tissue Forceps, 7x7 teeth

160mm, 6¹/₄"

130-554-160

200mm, 8"

130-554-200



DEBAKEY

Atraumatic Forceps, 2.0 mm wide, 160mm, 6¹/₄"

Straight

290-552-160



GREEN

Fixation Forceps, 12mm jaws, 110mm, 4¹/₃"

Delicate teeth

400-029-012



GRAEFE

Fixation Forceps, 4.5mm wide, 110mm, 4¹/₃"

7x8 teeth

400-025-110



KIRBY-BARRAQUER

Fixation Forceps, 110mm, 4¹/₃"

Delicate teeth

400-084-100



BEASLEY-BABCOCK

Tissue Forceps, 4x5 teeth, 125mm, 5"

Straight

130-561-125



ADSON
TC Dissecting Forceps

120mm, 4 ³ / ₄ "	130-532-120
150mm, 6"	130-532-150



MICRO-ADSON
TC Dressing Forceps

120mm, 4 ³ / ₄ "	130-538-120
150mm, 6"	130-538-150



STANDARD
TC Dressing Forceps

145mm, 5 ³ / ₄ "	130-518-145
160mm, 6 ¹ / ₄ "	130-518-160
180mm, 7"	130-518-180



SEMKEN
TC Dressing Forceps

150mm, 6"	130-512-150
-----------	-------------



CUSHING
TC Dressing Forceps

180mm, 7"	130-536-175
-----------	-------------



POTTS-SMITH
TC Dressing Forceps

150mm, 5 ³ / ₄ "	130-542-150
180mm, 6 ¹ / ₄ "	130-542-180
210mm, 7"	130-542-210



MCINDOE
TC Dressing Forceps

150mm, 6"

130-522-150



TICKNER
TC Dressing Forceps, square tip

150mm, 6"

130-536-150



GERALD
TC Dressing Forceps, 170mm, 6²/₃"

170mm, 6³/₄"

130-516-170



CUSHING-TAYLOR
TC Dressing Forceps, bayonet shaped, dissector end

180mm, 7"

130-541-180



DEBAKEY
TC Atraumatic Forceps

1.5mm wide

2.0mm wide

2.7mm wide

160mm, 6¹/₄"

130-568-150

130-570-160

130-572-160

200mm, 8"

130-568-190

130-570-200

130-572-200

240mm, 9¹/₂"

130-568-240

130-570-240

130-572-240

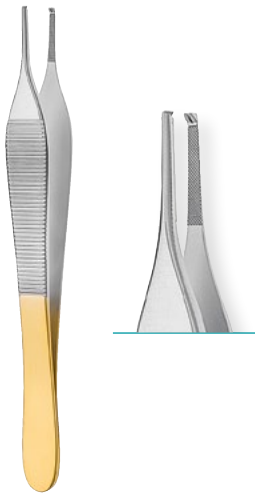

ADSON

TC Tissue Forceps, 1x2 teeth, with platform

120mm, 4³/₄"

130-534-120

150mm, 6"

130-534-150

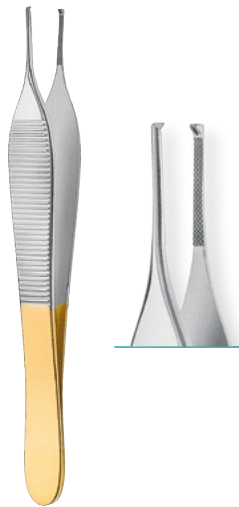

MICRO-ADSON

TC Tissue Forceps, 1x2 teeth, with platform

120mm, 4³/₄"

130-537-120

150mm, 6"

130-537-150



ADSON-BROWN

TC Tissue Forceps, 7x7 teeth

120mm, 4³/₄"

130-529-120

150mm, 6"

130-529-150



SEMKEN

TC Tissue Forceps, 1x2 teeth, with platform

150mm, 6"

130-524-150

180mm, 7"

130-524-180



GERALD

TC Tissue Forceps, 1x2 teeth, serrated, with platform

180mm, 7"

130-518-170



GILLIES

TC Tissue Forceps, 1x2 teeth, with platform

150mm, 6"

130-520-150



OEHLER

TC Tissue Forceps, 1x2 teeth, with platform

145mm, 5 ³ / ₄ "	130-522-145
--	-------------

160mm, 6 ¹ / ₄ "	130-522-160
--	-------------

180mm, 7"	130-522-180
-----------	-------------



TITAN ADSON

Dressing Forceps

120mm, 4 ³ / ₄ "	130-242-120
--	-------------

150mm, 6"	130-242-150
-----------	-------------



TITAN ADSON-BROWN

Tissue Forceps, 7x7 teeth

120mm, 4 ³ / ₄ "	130-243-120
--	-------------

150mm, 6"	130-243-150
-----------	-------------



TITAN GILLIES

Tissue Forceps, 1x2 teeth

150mm, 6"	130-239-150
-----------	-------------

MONOPOLAR FORCEPS





GILLIES

Tissue Forceps, 1x2 teeth, 150mm

Without plug	130-720-150
4mm male plug	130-719-150

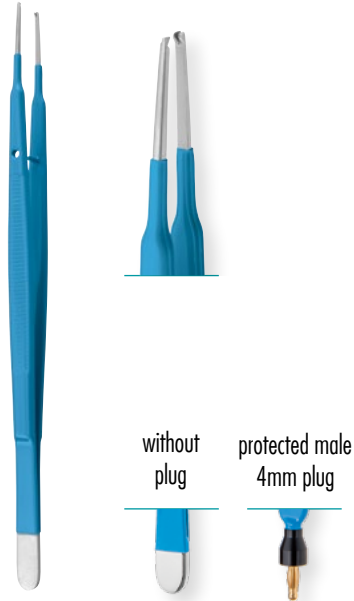

GERALD

Tissue Forceps, 1x2 teeth

	180mm, 7"	230mm, 8"
Without plug	130-750-180	130-750-230
4mm male plug	130-749-180	130-749-230

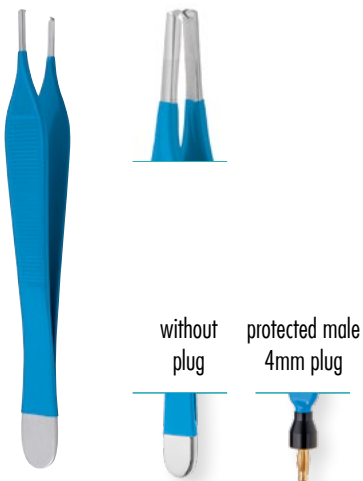

ADSON

Tissue Forceps, 1x2 teeth, 2mm tip, 120mm

Without plug	130-740-120
4mm male plug	130-746-120

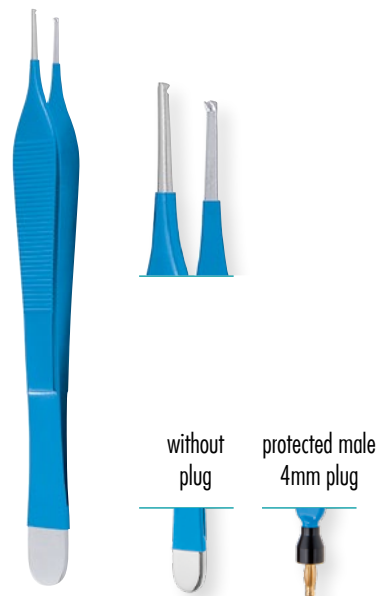

MICRO-ADSON

Tissue Forceps, 1x2 teeth, 150mm

Without plug	130-750-150
4mm male plug	130-751-150

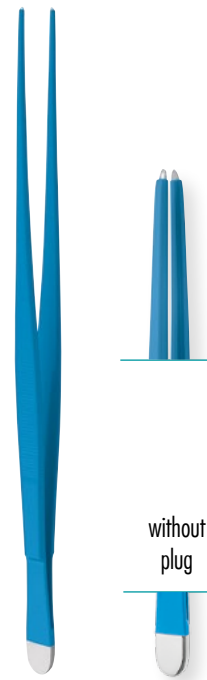

SULIVAN

Forceps, very delicate, smooth jaws, 1mm tips, 250mm

Without plug	130-743-250
--------------	-------------

For suitable monopolar cables see page 76.



Without plug

Male 4mm plug

180mm, 7"	130-738-180	130-752-180
210mm, 8 ¹ / ₄ "	130-738-210	130-752-210
250mm, 10"	130-738-250	130-752-250
300mm, 12"	130-738-300	130-752-300

POTTS-SMITH

Dressing Forceps, serrated, elevated shanks



Without plug

Male 4mm plug

180mm, 7"	130-741-180	130-748-180
210mm, 8 ¹ / ₄ "	130-741-210	130-748-210
250mm, 10"	130-741-250	130-748-250
300mm, 12"	130-741-300	130-748-300

POTTS-SMITH

Tissue Forceps, 1x2 teeth, elevated shanks



Without plug

Male 4mm plug

145mm, 5 ³ / ₄ "	130-740-145	130-747-145
180mm, 7"	130-740-180	130-747-180
210mm, 8 ¹ / ₄ "	130-740-210	130-747-210
250mm, 10"	130-740-250	130-747-250
300mm, 12"	130-740-300	130-747-300

POTTS-SMITH

Dressing Forceps, serrated



Without plug

Male 4mm plug

145mm, 5 ³ / ₄ "	130-753-145	130-754-145
180mm, 7"	130-753-180	130-754-180
210mm, 8 ¹ / ₄ "	130-753-210	130-754-210
250mm, 10"	130-753-250	130-754-250
300mm, 12"	130-753-300	130-754-300

POTTS-SMITH

Tissue Forceps, 1x2 teeth

For suitable monopolar cables see page 76.

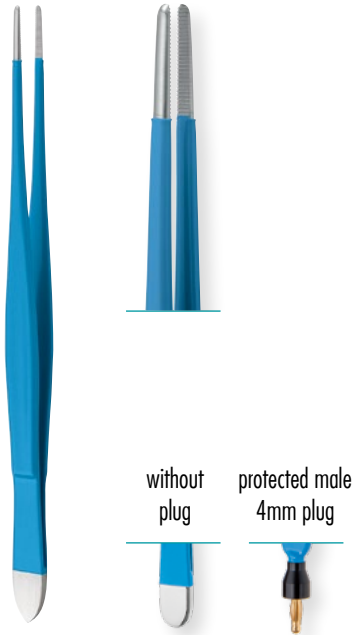

CUSHING
Dressing Forceps, serrated

	175mm, 7"	200mm, 8"
Without plug	130-736-175	130-736-200
4mm male plug	130-737-175	130-737-200



DEBAKEY
Atraumatic Forceps, 1.5mm tip

	160mm, 6 ¹ / ₄ "	200mm, 8"	240mm, 9 ¹ / ₂ "	300mm, 12"
1.5mm tip	290-850-160	290-850-200	290-850-240	290-850-300
2.0mm tip	290-851-160	290-851-200	290-851-240	290-851-300
2.4mm tip	290-852-160	290-852-200	290-852-240	290-852-300
2.7mm tip	290-853-160	290-853-200	290-853-240	290-853-300
3.5mm tip	290-854-160	290-854-200	290-854-240	290-854-300

For suitable monopolar cables see page 76.

BIPOLAR NON-STICK FORCEPS





NON-STICK
Bipolar Forceps, straight

Tip width	Total length	Flat plug	2-pin plug
0.3mm	150mm, 6"	700-010-150	700-012-150
	180mm, 7"	700-010-180	700-012-180
	200mm, 8"	700-010-200	700-012-200
	225mm, 9"	700-010-220	700-012-220
0.6mm	150mm, 6"	700-020-150	700-022-150
	180mm, 7"	700-020-180	700-022-180
	200mm, 8"	700-020-200	700-022-200
	225mm, 9"	700-020-220	700-022-220
1.0mm	150mm, 6"	700-030-150	700-032-150
	180mm, 7"	700-030-180	700-032-180
	200mm, 8"	700-030-200	700-032-200
	225mm, 9"	700-030-220	700-032-220
2.0mm	150mm, 6"	700-040-150	700-042-150
	180mm, 7"	700-040-180	700-042-180
	200mm, 8"	700-040-200	700-042-200
	225mm, 9"	700-040-220	700-042-220



NON-STICK
Bipolar Forceps, angled

Tip width	Total length	Flat plug	2-pin plug
0.3mm	150mm, 6"	700-011-150	700-013-150
	180mm, 7"	700-011-180	700-013-180
	200mm, 8"	700-011-200	700-013-200
	225mm, 9"	700-011-220	700-013-220
0.6mm	150mm, 6"	700-021-150	700-023-150
	180mm, 7"	700-021-180	700-023-180
	200mm, 8"	700-021-200	700-023-200
	225mm, 9"	700-021-220	700-023-220
1.0mm	150mm, 6"	700-031-150	700-033-150
	180mm, 7"	700-031-180	700-033-180
	200mm, 8"	700-031-200	700-033-200
	225mm, 9"	700-031-220	700-033-220
2.0mm	150mm, 6"	700-041-150	700-043-150
	180mm, 7"	700-041-180	700-043-180
	200mm, 8"	700-041-200	700-043-200
	225mm, 9"	700-041-220	700-043-220















NON-STICK
Bipolar Forceps, bayonet

Tip width	Total length	Flat plug	2-pin plug
0.3mm	150mm, 6"		700-052-150
	180mm, 7"	700-050-180	700-052-180
	200mm, 8"	700-050-200	700-052-200
	225mm, 9"	700-050-220	700-052-220
0.6mm	150mm, 6"		700-062-150
	180mm, 7"	700-060-180	700-062-180
	200mm, 8"	700-060-200	700-062-200
	225mm, 9"	700-060-220	700-062-220
1.0mm	150mm, 6"		700-072-150
	180mm, 7"	700-070-180	700-072-180
	200mm, 8"	700-070-200	700-072-200
	225mm, 9"	700-070-220	700-072-220
2.0mm	150mm, 6"		700-082-150
	180mm, 7"	700-080-180	700-082-180
	200mm, 8"	700-080-200	700-082-200
	225mm, 9"	700-080-220	700-082-220













For suitable monopolar cables see page 76.

MONOPOLAR CABLES

Generator end									
			4mm socket	4mm socket, ang.	2mm plug	4mm plug	3mm socket	4mm hexagon	4mm plug
	3 m	700-501-303							
	5 m	700-501-503							
	3 m	700-501-300							
	5 m	700-501-500							
	3 m	700-280-030	700-290-030	700-291-030			700-292-030	700-293-030	700-293-033
	5 m	700-280-050	700-290-050	700-291-050					700-293-035
	3 m	700-360-031	700-361-030	700-362-030	700-363-030	700-364-030			700-370-030
	5 m	700-360-051	700-361-050	700-362-050	700-363-050				700-370-050
	3 m	700-285-030		700-286-030	700-286-130				700-286-230
	5 m	700-285-050		700-286-050					
	3 m	700-101-030	700-102-030	700-103-030				700-105-030	
	5 m	700-101-050		700-103-050			700-104-050		

BIPOLAR CABLES

Generator end								
			Flat Plug	Flat plug, angled	Flat plug, square	2-pin plug	2-pin plug, angled	2-pin plug, angled
	3 m	700-350-030	300-860-100	700-350-130	700-351-030	700-345-403	700-345-003	
	5 m	700-350-050	300-860-111	700-350-150	700-351-050	700-345-405	700-345-005	
	3 m	700-101-001	700-100-130	700-101-130	700-100-102	700-101-230		
	5 m	700-100-101	700-100-150	700-101-150	700-100-103	700-101-250		
	3 m	700-287-030	700-200-130	700-287-130	700-200-132	700-287-230		
	5 m	700-287-050	700-200-150	700-287-150	700-200-152	700-287-250		
	3 m	700-351-031	700-300-003	700-351-131	700-300-203	700-351-231	700-300-403	
	5 m	700-351-051	700-300-005	700-351-151	700-300-205	700-351-251	700-300-405	
	3 m	700-500-300						
	5 m	700-500-500						

* Not for sale within Europe

FORCEPS & CLAMPS

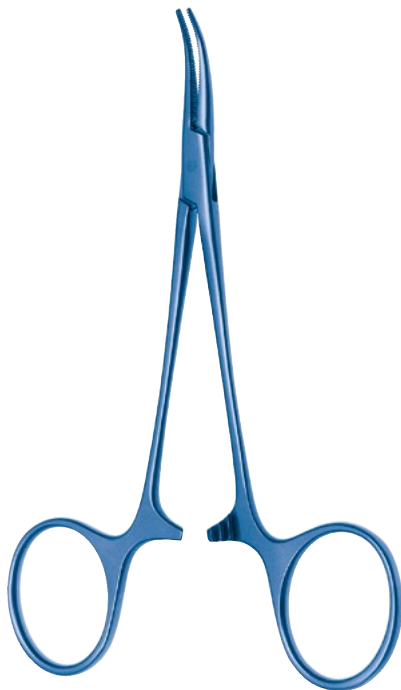

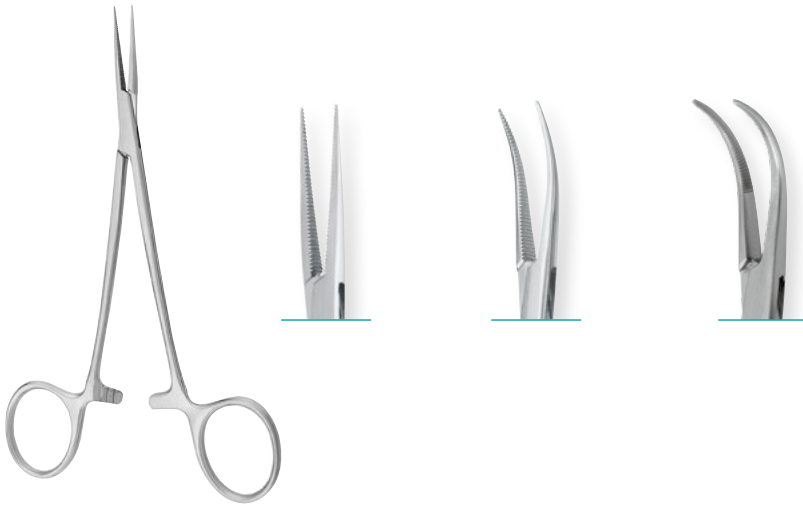

JACOBSON

Hemostatic Forceps, 0.3mm tips

	Straight	Curved	Strongly curved
100mm, 4"	140-160-100	140-161-100	–
130mm, 5 ¹ / ₈ "	140-160-130	140-161-130	–
190mm, 7 ¹ / ₂ "	140-160-190	140-161-190	140-162-190
230mm, 9"	140-160-230	140-161-230	–



MICRO-MOSQUITO

Hemostatic Forceps, 120mm, 4³/₄"

Straight	140-270-120
Curved	140-271-120



KOCHER (DELICATE)

Hemostatic Forceps, 1x2 teeth

	Straight	Curved
130mm, 5 ¹ / ₈ "	140-318-130	140-319-130
140mm, 5 ¹ / ₂ "	140-318-140	140-319-140
160mm, 6 ¹ / ₄ "	140-318-160	140-319-160



MICRO-ADSON

Dissecting Forceps, 140mm, 5¹/₂"

Curved	140-338-140



HARTMANN

Titanium Hemostatic Forceps, 90mm, 3 1/2"

Straight	140-258-090
Curved	140-259-090



HALSTEAD-MOSQUITO

Titanium Hemostatic Forceps, 125mm, 5"

Straight	140-258-125
Curved	140-259-125



MICRO HALSTEAD-MOSQUITO

Titanium Hemostatic Forceps, 125mm, 5"

Straight	140-262-125
Curved	140-263-125



ALLIS

Tissue Forceps, 5x6 teeth

150mm, 6"	310-014-150
190mm, 7 1/2"	310-014-190



ALLIS

TC Atraumatic Tissue Grasping Forceps

140mm, 5 2/3"	310-022-140
---------------	-------------



JOHNS-HOPKINS

Bulldog Clamp, 38mm, 1 1/2"

Straight	140-050-038
Curved	140-051-038



DIETRICH-DEBAKEY

Micro Bulldog Clamp, angled, 3g weight

45mm, 14mm jaws	140-221-425
50mm, 20mm jaws	140-221-426

More bulldog clamps in our RZ Bulldog Clamps brochure.



D'ASSUMPCAO

Face Lift Forceps, without ratchet

160mm, 6 ¹ / ₄ "	260-520-010
--	-------------

260mm, 10 ¹ / ₄ "	260-520-016
---	-------------

For precise marking of dissected facial flaps for excision.



D'ASSUMPCAO

Face Lift Forceps, with ratchet

160mm, 6 ¹ / ₄ "	260-520-020
--	-------------

260mm, 10 ¹ / ₄ "	260-520-026
---	-------------

For precise marking of dissected facial flaps for excision.



LOCKWOOD

Abdominal Demarcator

320mm, 12 ¹ / ₂ "	260-268-310
---	-------------

470mm, 18 ¹ / ₂ "	260-268-410
---	-------------

For the measuring of abdominal flaps.

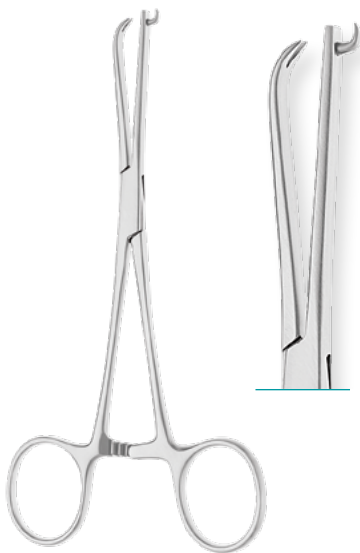

MARTEN

Flap Forceps, 145mm, 5³/₄"

Without ratchet	260-233-145
-----------------	-------------

With ratchet	260-234-145
--------------	-------------

For accurate marking of skin flaps.



PITANGUY

Flap Demarcator

150mm, 6"	260-267-155
-----------	-------------

260mm, 10 ¹ / ₄ "	260-267-260
---	-------------

For accurate marking of facial or abdominal flaps that are to be excised.



MARTEL

Flap Grasping Forceps

140mm, 5 ¹ / ₂ "	140-267-140
--	-------------

NEEDLE HOLDERS

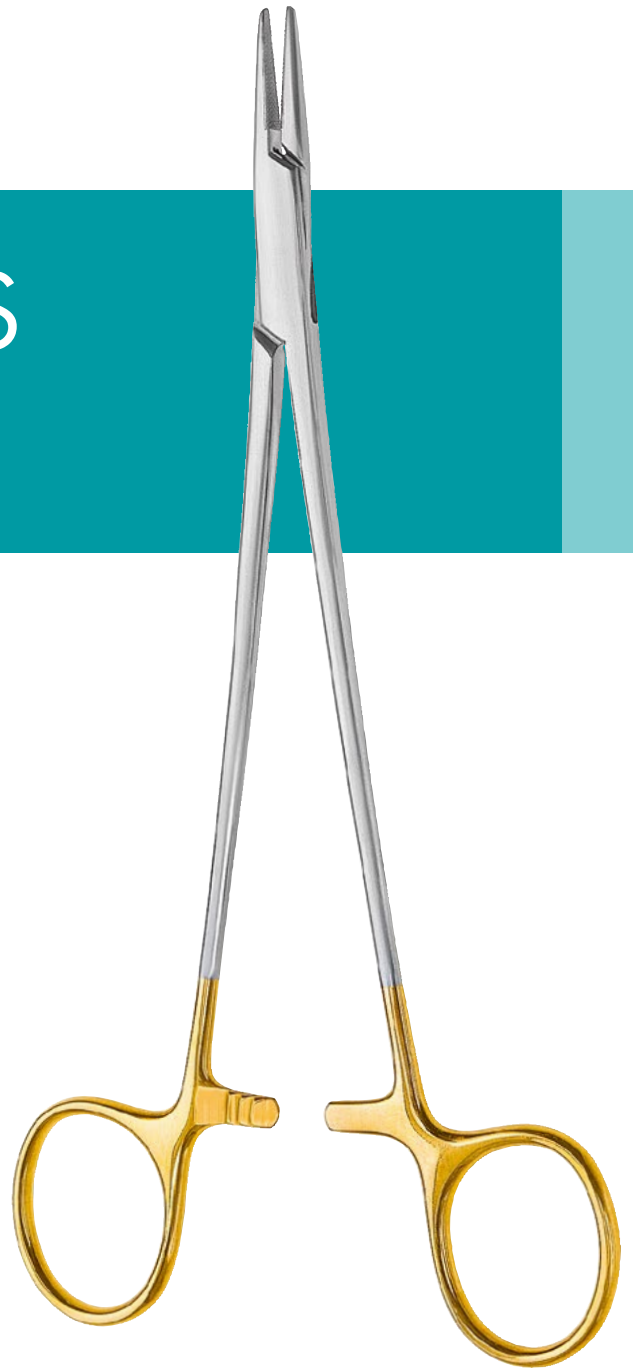

Depending on their application, our TCs are equipped with the most suitable TC-inserts.

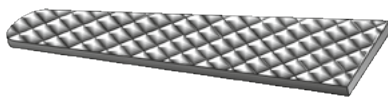

R - Regular 0.5mm

For use with sutures up to size 4-0

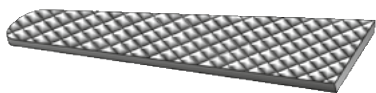

F - Fine 0.4mm

For delicate needles and sutures up to sizes 5-0 and 6-0

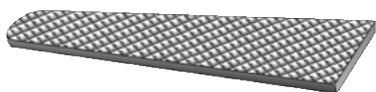

EF - Extra-Fine 0.3mm

For use with micro-needles and sutures up to size 10-0



S - Smooth

For delicate needles and sutures from sizes 7-0 to 10-0

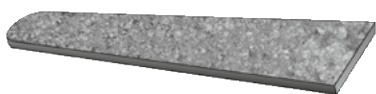

D - Diamond dusted

For very delicate needles and suture material



- 1** Milled inserts of solid tungsten carbide for long-lasting secure grip of suture needles
- 2** Bevelled edges to prevent catching of suture material
- 3** Vacuum-hardened throughout for consistent flexibility and alignment
- 4** Mirror finished gold-plated ring handles for easy identification
- 5** Precision-cut ratchet for safe opening and closing



PAR
TC Needle Holder, very delicate, serrated

115mm, 4 ³ / ₄ "	180-555-115
120mm, 4 ³ / ₄ "	180-558-120
135mm, 4 ³ / ₄ "	180-558-135



DERF
TC Needle Holder, serrated

120mm, 4 ³ / ₄ "	180-532-120
--	-------------



CONVERSE
TC Needle Holder, serrated

120mm, 4 ³ / ₄ "	180-544-120
--	-------------



FOSTER-GILLIES
TC Needle Holder

120mm, 4 ³ / ₄ "	180-570-120
--	-------------



MINI OLSEN-HEGAR
TC Needle Holder, 120mm, 4³/₄"

Fine	180-568-120
Smooth	180-569-120

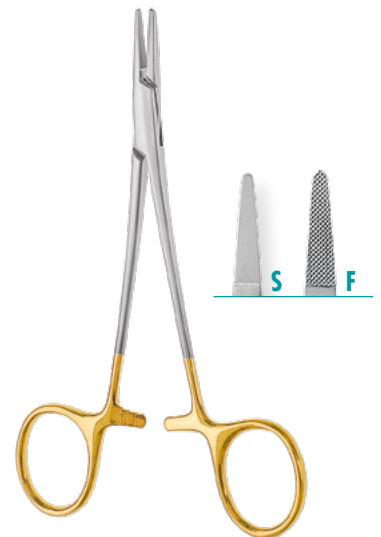

HALSEY
TC Needle Holder, 130mm, 5"

Smooth	180-536-130
Fine	180-537-130

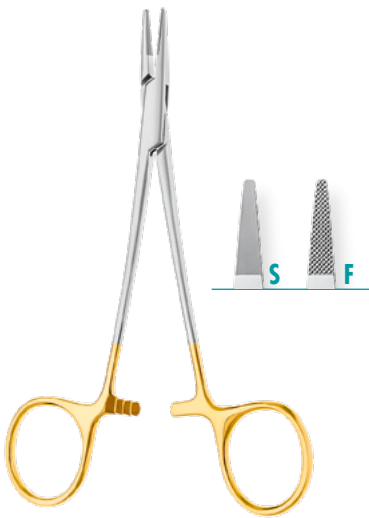

WEBSTER
TC Needle Holder, slim jaw, 130mm, 5"

Smooth	180-538-130
Fine	180-539-130



WEBSTER
TC Needle Holder, smooth jaws

130mm, 5"	180-570-130
-----------	-------------

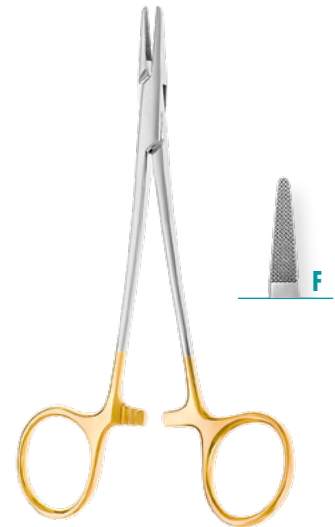

NEIVERT
TC Needle Holder

130mm, 5 1/8"	180-533-130
---------------	-------------



RYDER
TC Vascular Needle Holder, 2mm jaw

130mm, 5 1/8"	180-560-130
150mm, 6"	180-560-160
180mm, 7"	180-560-180
200mm, 8"	180-560-200

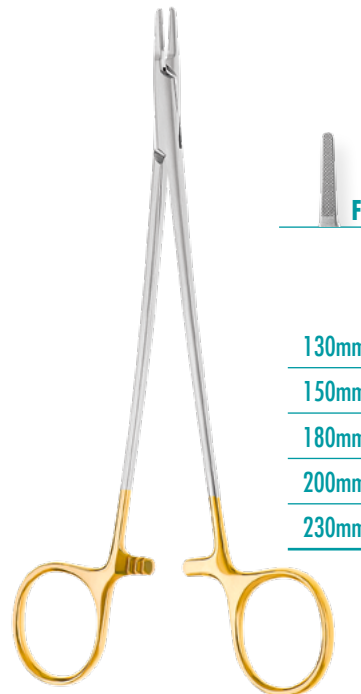

RYDER-VASCULAR
TC Needle Holder, 1.5mm jaw

130mm, 5 1/8"	180-561-130
150mm, 6"	180-561-150
180mm, 7"	180-561-180
200mm, 8"	180-561-200
230mm, 9"	180-561-230



125mm, 5"	180-550-125
140mm, 5 ¹ / ₂ "	180-550-140
160mm, 6 ¹ / ₄ "	180-550-160
180mm, 7"	180-550-180
200mm, 7 ⁷ / ₈ "	180-550-200
240mm, 9 ¹ / ₂ "	180-550-240
260mm, 10 ¹ / ₄ "	180-550-260
300mm, 12"	180-550-300
400mm, 16"	180-550-400

MAYO-HEGAR
TC Needle Holder, straight, serrated

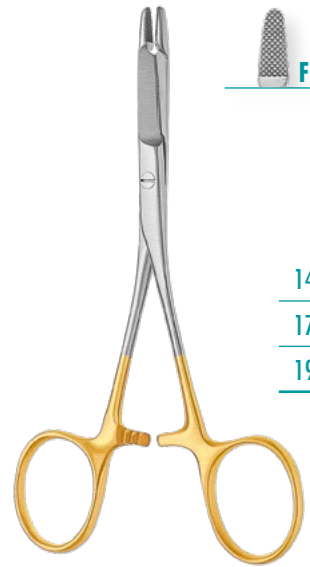

140mm, 5 ¹ / ₂ "	180-568-140
170mm, 6 ² / ₃ "	180-568-170
190mm, 7 ¹ / ₂ "	180-568-180

OLSEN-HEGAR
TC Vascular Needle Holder, serrated



150mm, 6"	180-540-150
180mm, 7"	180-540-180
200mm, 8"	180-540-200
230mm, 9"	180-540-230
260mm, 10 ¹ / ₄ "	180-540-260

CRILE-WOOD
TC Needle Holder, straight, serrated



Straight	
150mm, 6"	180-548-150
180mm, 7"	180-548-180
200mm, 8"	180-548-200
230mm, 9"	180-548-230
Curved	
150mm, 6"	180-549-150
180mm, 7"	180-549-180
200mm, 8"	180-549-200
230mm, 9"	180-549-230

DEBAKEY
TC Needle Holder, serrated



KILNER
TC Needle Holder, s-curved, serrated

135mm, 5¹/₃" 180-525-135



HEGAR-BAUMGARTNER
TC Needle Holder, serrated

140mm, 5¹/₂" 180-534-140



BABY CRILE-WOOD
TC Needle Holder, serrated

150mm, 6" 180-542-150

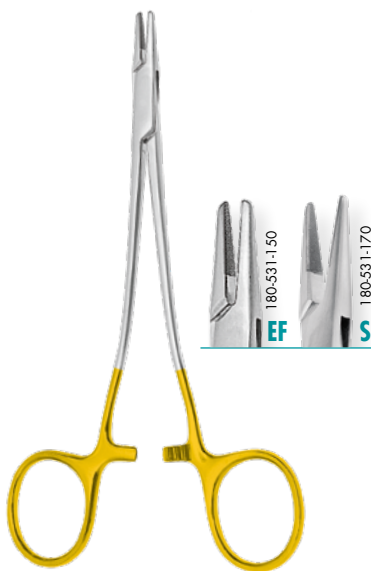

SENNING
TC Needle Holder, serrated

150mm, 6" 180-531-150
170mm, 6²/₃" 180-531-170



MINI-GILLIES
TC Needle Holder, curved, serrated

150mm, 6" 180-588-150



GILLIES
TC Needle Holder, curved, serrated

160mm, 6¹/₄" 180-570-160



TC Wire Holding Forceps, square jaws, serrated

160mm, 6¹/₄"

180-571-150

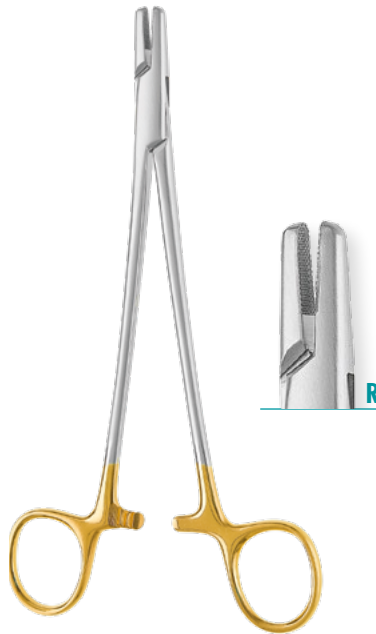

TC Wire Holding Forceps, round jaws, serrated

130mm, 5¹/₈"

180-569-130

180mm, 7"

180-569-180



OLSEN-HEGAR

TC Needle Holder, serrated

170mm, 6³/₄"

180-567-170

190mm, 7¹/₂"

180-567-190

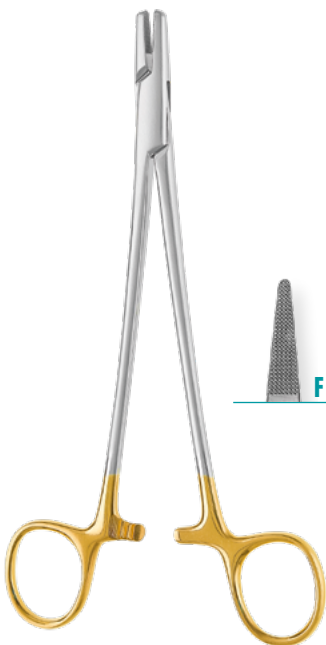

SAROT

TC Needle Holder, serrated

180mm, 7"

180-545-180

200mm, 8"

180-545-200

260mm, 10¹/₄"

180-545-260



BERRY

TC Wire Holding Forceps, round jaws, serrated

200mm, 8"

180-570-200



SENNING
Needle Holder, slim pattern

170mm, 6³/₄"

180-335-170

Suitable for suturing in rhinoplastic surgery.



DEBAKEY
Needle Holder, diamond dusted, 1mm tip

180mm, 7"

180-648-180



LOEFFLER
Needle Holder, delicate short jaws, diamond dusted

150mm, 6"

180-755-150



RYDER
TC Titanium Needle Holder, delicate tips

150mm, 6" 180-661-150

180mm, 7" 180-661-180

190mm, 7 1/2" 180-661-190

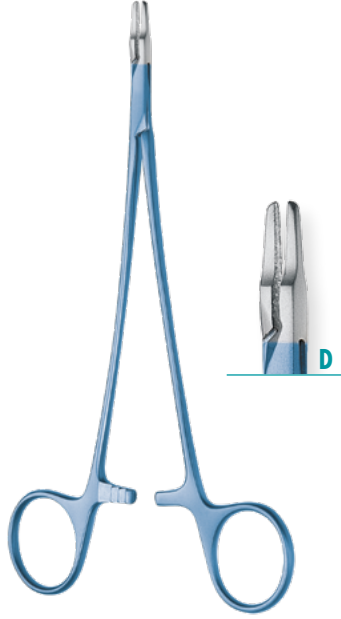

RYDER
Titanium Needle Holder, diamond dusted, 2mm tip

190mm, 7 1/2" 180-660-190

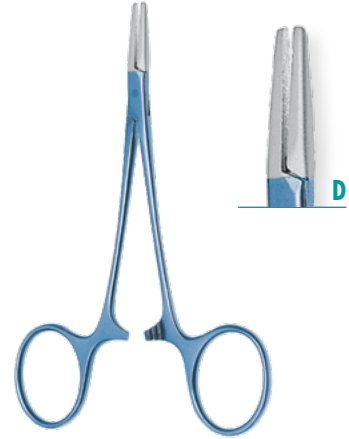

HALSEY
Titanium Needle Holder, diamond dusted

125mm, 5" 180-670-125



DERF
Titanium Needle Holder, diamond dusted

125mm, 5" 180-671-115



Titanium Vascular Needle Holder
delicate, diamond dusted

160mm, 6 1/4" 180-674-160

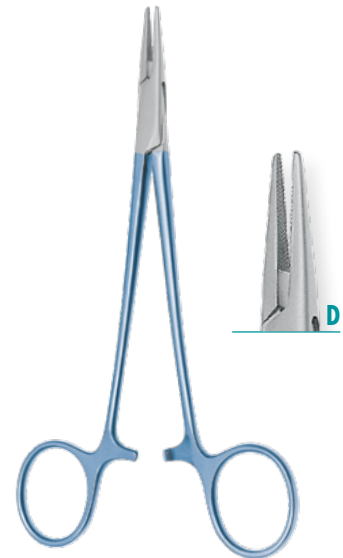

DEBAKEY
Titanium Needle Holder, diamond dusted

160mm, 6 1/4" 180-675-160



BARRAQUER

Micro Needle Holder, curved, smooth, delicate, with ratchet, \varnothing 8mm round handle

135mm, 5¹/₃"

400-350-135



BARRAQUER

Micro Needle Holder, curved, smooth, without ratchet, \varnothing 8mm round handle

130mm, 5¹/₈"

400-348-135



BARRAQUER

TC Micro Needle Holder, serrated, with ratchet, \varnothing 8mm round handle, 140mm, 5¹/₂"

Straight

180-512-145

Curved

180-513-145



CASTROVIEJO

TC Micro Needle Holder, serrated, with ratchet, sand-blasted, flat handle, 140mm, 5¹/₂"

Straight

180-520-145

Curved

180-522-145



JACOBSON

Micro Needle Holder, diamond dusted, with ratchet, \varnothing 8mm round handle, 180mm, 7"

Straight

250-264-246

Curved

250-264-247



Micro Needle Holder Forceps, balanced, curved, with tying platform, round handle, 0.6 mm tip

150mm, 6"

251-660-150

More Micro Needle Holders illustrated in our Micro Vascular and Micro Neuro Catalogue.

WOUND RETRACTORS



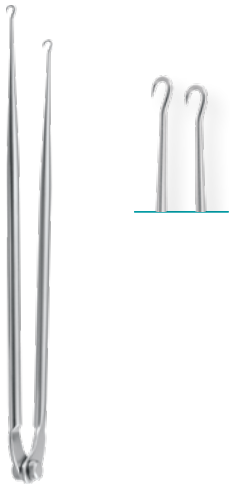

PENN (HUMBY)
Double Skin Hook, sharp

115mm, 4½"

170-021-115

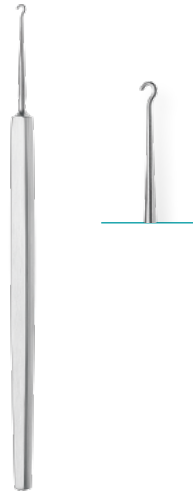

GRAEFFE
Skin Hook, 120mm, 4¾"

Sharp

170-010-125

Blunt

170-011-125

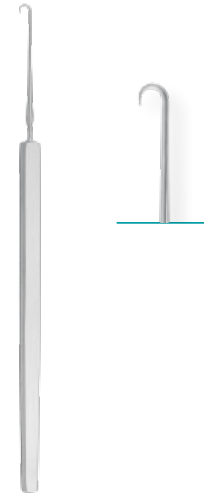

O'CONNOR
Skin Hook, sharp

120mm, 4¾"

170-040-160



CUSHING
Skin Hook, sharp

140mm, 5½"

170-015-140



KILNER
Skin Hook, sharp, detachable tip

155mm, 6⅛"

230-203-002

tip only

230-203-102



KILNER
Skin Hook, sharp

150mm, 6"

230-203-150



BARSKY
Double Skin Hook, sharp, 150mm, 6"

Non-detachable	170-019-000
----------------	-------------



KLEINERT-KUTZ
Skin Hook, sharp, 160mm, 6¹/₂"

3mm	170-020-001
5mm	170-020-002
8mm	170-020-003



CLOWARD
Skin Hook, sharp

165mm, 6 ¹ / ₂ "	170-014-165
--	-------------

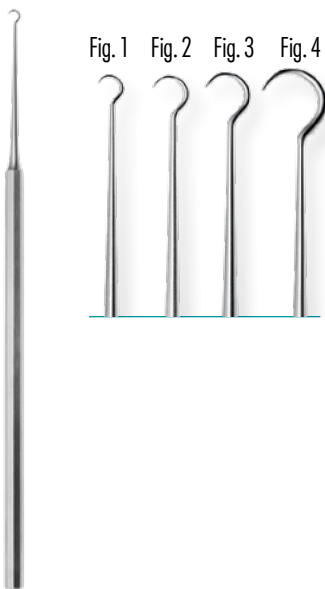

NIRO
Skin Hook, sharp, 170mm, 6³/₄"

Fig. 1	170-041-001
Fig. 2	170-041-002
Fig. 3	170-041-003
Fig. 4	170-041-004



GILLIES
Skin Hook, sharp, square handle

175mm, 7"	170-237-175
-----------	-------------

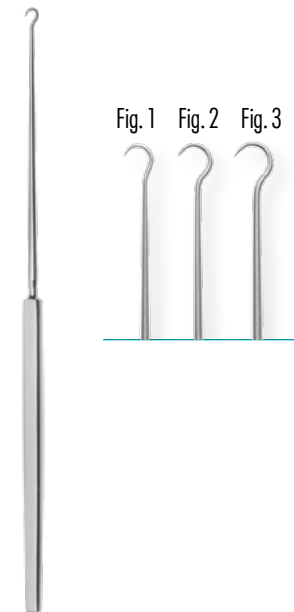

GILLIES
Skin Hook, sharp, 180mm, 7"

Fig. 1	230-205-180
Fig. 2	230-207-180
Fig. 3	230-209-180



GUTHRIE

Fine Wound Retractor, 2 prongs, sharp

120mm, 4 ³ / ₄ "	170-042-130
130mm, 5 ¹ / ₈ "	170-044-130

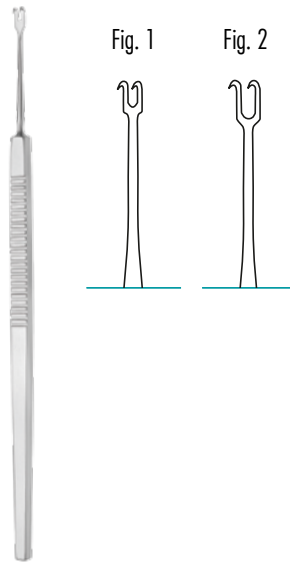

GUTHRIE

Fine Wound Retractor, 2 prongs, sharp, 160mm, 6¹/₄"

Fig. 1	170-042-160
Fig. 2	170-044-160



RZ-SQUARE

Fine Wound Retractor, 2 prongs, 175mm, 7"

Blunt	170-122-175
Sharp	170-123-175



LAHEY

Fine Wound Retractor, sharp, 120mm, 4³/₄"

1 prong	170-031-120
2 prongs	170-033-120
3 prongs	170-034-120



KNAPP

Fine Wound Retractor, 4 prongs, sharp, 130mm, 5¹/₈"

Sharp	170-080-001
Blunt	170-080-002

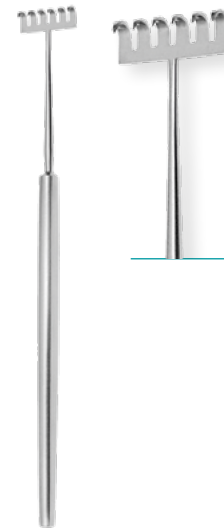

RZ

Fine Wound Retractor, 6 prongs, sharp

135mm, 5 ¹ / ₃ "	170-081-135
--	-------------

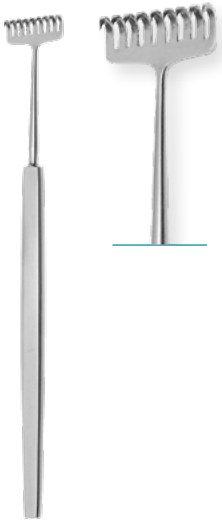

MILLER

Fine Wound Retractor, 9 prongs, 135mm, 5¹/₃"

Sharp	170-085-130
Blunt	170-086-130



Wound Retractor, 5 prongs, sharp,
15mm wide, square handle

175mm, 6 ⁷ / ₈ "	170-879-175
--	-------------



BABY SENN-MILLER

Retractor, 3 prongs, 20x7mm blade, 160mm, 6¹/₄"

Blunt	170-213-160
Sharp	170-214-160



FOMON

Alar Retractor, 2 buttoned prongs

160mm, 6 ¹ / ₄ "	230-280-160
--	-------------



FOMON

Alar Retractor, insulated, 2 buttoned prongs

160mm, 6 ¹ / ₄ "	230-780-160
--	-------------

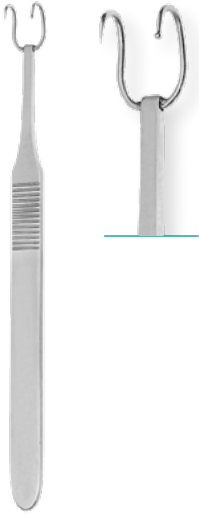

COTTLE

Alar Retractor, 2 prongs, sharp with one buttoned prong, 140mm, 5¹/₂"

Buttoned right 230-281-140

Buttoned left 230-282-140

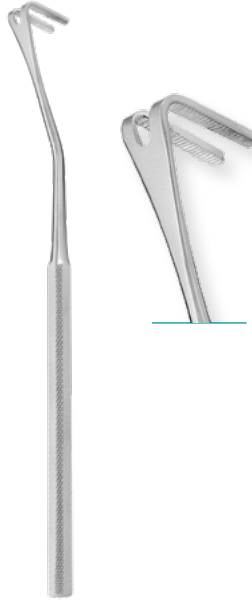

STACK

Fork Retractor, 15mm deep, square handle

175mm, 6⁷/₈" 230-195-175



MOBERG

Wound and Skin Retractor, 17x5mm blade

175mm, 6⁷/₈" 170-136-175

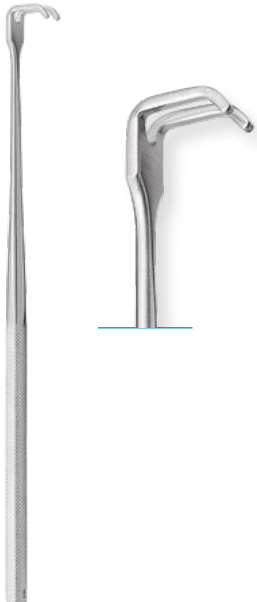

Retractor, 15mm blade length, 2 prongs, square handle

175mm, 6⁷/₈" 170-275-175



BUCK-GRAMCKO

Retractor, 25x6mm, square handle

175mm, 6⁷/₈" 170-296-175

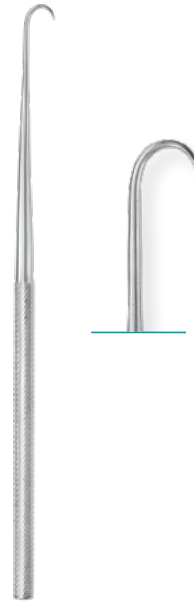

Hook, 1 prong, sharp, 9mm deep, square handle

175mm, 6⁷/₈" 170-079-175



RZ

Skin Retractor, fenestrated, square handle, 175mm, 6⁷/₈"

12x14mm	230-140-175
13x16mm	230-160-175
14x19mm	230-190-175

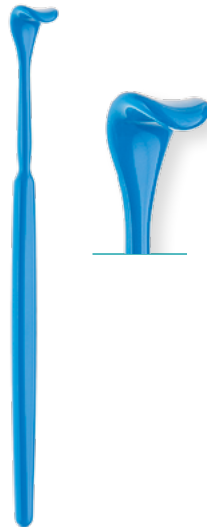

DESMARRES

Lid Retractor, insulated

	Total length	
10mm blade	130mm, 5"	170-510-130
13mm blade	140mm, 5 ¹ / ₂ "	170-513-145
12mm blade	160mm, 6 ¹ / ₄ "	170-512-160
13mm blade	160mm, 6 ¹ / ₄ "	170-513-160

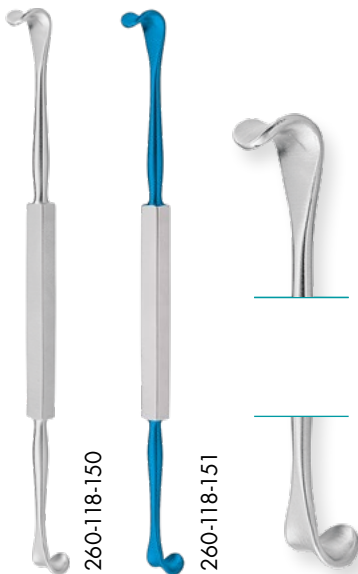

DESMARRES

Lid Retractor, 8mm/10mm, 150mm, 6"

Non-insulated	260-118-150
Insulated	260-118-151

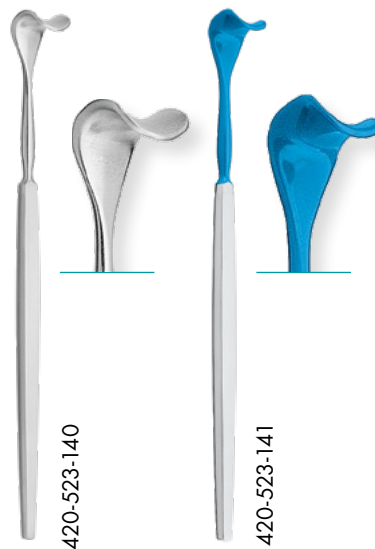

COTTLE

Alar Retractor, 10x12mm, 140mm, 5¹/₂"

Non-insulated	420-523-140
Insulated	420-523-141



MASING

Alar Retractor, 6x12mm, 140mm, 5¹/₂"

Non-insulated	420-520-140
Insulated	420-520-141

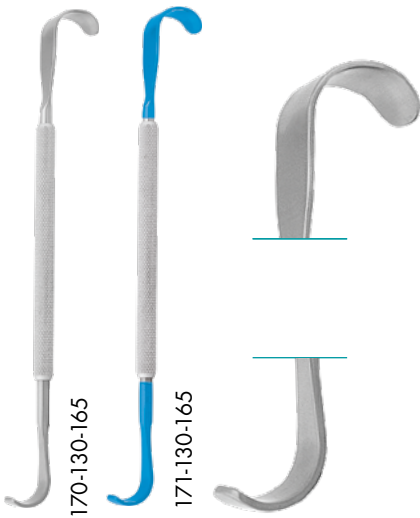

KASDEN

Retractor, 165mm, 6¹/₂"

Non-insulated

170-130-165

Insulated

171-130-165



COTTLE-NEIVERT

Alar Retractor, 2 blunt prongs, saw/knife guide

200mm, 8"

230-260-200

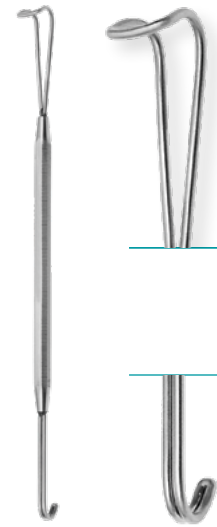

NEIVERT

Nasal Retractor, double-ended, with knife guide

160mm, 6¹/₄"

170-036-180



FREEMAN
Rake Retractor, 4 prongs, with thumb ring

50mm, 2"

260-012-198



FREEMAN
Rake Retractor, 4 prongs, reversed, thumb ring

50mm, 2"

260-012-398



FREEMAN
Rake Retractor, 4 prongs, 2 recessed, thumb ring

50mm, 2"

260-015-198

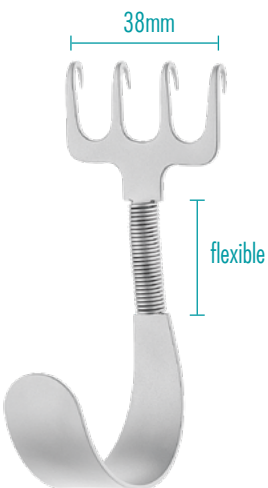

GORNEY
Rake Retractor, 4 prongs, sharp, with spring

75mm, 3"

260-020-038



FREEMAN
Rake Retractor, 4 prongs, sharp

100mm, 4"

260-012-192



FREEMAN
Rake Retractor, 4 prongs (2 recessed), sharp

100mm, 4"

260-013-192



FREEMAN
Rake Retractor, 4 prongs, sharp, 2 prongs recessed

180mm, 7"

260-012-193



FREEMAN
Rake Retractor, 4 prongs, sharp

180mm, 7"

260-012-195



FREEMAN
Rake Retractor, 4 prongs, sharp, 2 prongs recessed

180mm, 7"

260-012-191



FREEMAN-ADAMSON
Face Lift Retractor, 4 prongs, angled, sharp

180mm, 7"

260-013-191



VAN SICKLE
Rake Retractor, 4 prongs (2 recessed), blunt

180mm, 7"

260-012-194



Rake Retractor, 3 prongs, sharp

115mm, 4 1/2"

260-210-130



MILLARD
Thimble Hook

1 prong

260-418-100



MILLARD
Thimble Hook

2 prongs

260-418-120



ANDERSON
Retractor, 3 prongs

120mm, 4³/₄"

260-012-212



ANDERSON
Retractor, 5 prongs

120mm, 4³/₄"

260-012-210



KILNER
Nasal Retractor, 80mm, 3¹/₈"

Sharp/sharp

420-184-100

Blunt/blunt

420-185-100



CONVERSE
Alar Retractor, double-ended, 120mm, 4³/₄"

Blunt

260-501-120

Sharp

260-502-120



RZ-NOSE
RZ Nasal Retractor with Thimble Hook, swivelling

85mm, 3¹/₃"

260-200-110



SISSON
Wire Spring Retractor, 1x1 sharp prongs

105mm, 4 ¹ / ₈ "	260-711-110
--	-------------

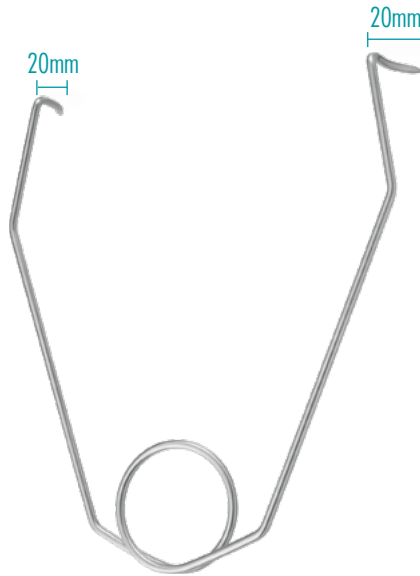

FARR
Retractor Wire, sharp, 20mm

140mm, 5 ¹ / ₂ "	170-711-140
--	-------------



ALM
Self Retaining Retractor, 4x4 teeth, 100mm, 4"

Sharp	170-714-100
Blunt	170-715-100

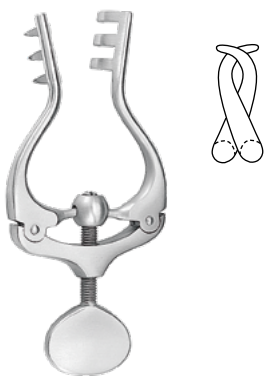

JANSEN
Self Retaining Retractor, 3x3 teeth, 100mm, 4"

Sharp	170-720-100
Blunt	170-723-100



WEITLANER-LOKTITE
Self Retaining Retractor, 2x3 teeth, 115mm, 4¹/₂"

Blunt	170-749-105
Semi-sharp	170-750-105



COX
Ocular Shield incl. suction cup

24x21mm, S	400-850-240
25.5x22mm, M	400-850-255
26.5x23mm, L	400-850-265

NASAL RASPS



The major advantages of the RZ tungsten carbide rasps over conventional models are their superior rasping/cutting ability, increased longevity and a clean, precise tissue removal.



TC-Inserts	Fig. 1 0.8	Fig. 2 1.1	Fig. 3 1.3	Fig. 4 1.6	Fig. 5 1.8	Fig. 6 2.0	Fig. 7 2.4	Fig. 8 2.6	Fig. 9 2.8	Fig. 10 3.0
Partition										



Fig. 1	420-491-165
Fig. 2	420-492-165
Fig. 3	420-493-165
Fig. 4	420-494-165
Fig. 5	420-495-165
Fig. 6	420-496-165
Fig. 7	420-497-165
Fig. 8	420-498-165
Fig. 9	420-499-165
Fig. 10	420-500-165

MALTZ
TC Nasal Rasp, 170mm, 6²/₃"



Fig. 1	420-491-230
Fig. 2	420-492-230
Fig. 3	420-493-230
Fig. 4	420-494-230
Fig. 5	420-495-230
Fig. 6	420-496-230
Fig. 7	420-497-230
Fig. 8	420-498-230

LAMB
TC Nasal Rasp, Ergo handle, 230mm, 9"



(Fig. 2 illustrated)

Fig. 2	420-480-200
Fig. 8	420-488-200

ASTON

TC Nasal Rasp, backward cutting, 200mm, 8"



Fig. 1/Fig. 2	420-660-219
Fig. 3/Fig. 4	420-660-214
Fig. 5/Fig. 6	420-660-216
Fig. 7/Fig. 8	420-660-218
Fig. 9/Fig. 10	420-660-220

FOMON

TC Nasal Rasp, 40x7mm, 210mm, 8^{1/4}"



Fig. 1	420-490-210
Fig. 2	420-491-210
Fig. 3	420-492-210
Fig. 4	420-493-210
Fig. 5	420-494-210
Fig. 6	420-495-210
Fig. 7	420-496-210
Fig. 8	420-497-210
Fig. 9	420-498-210
Fig. 10	420-499-210

PARKES

TC Nasal Rasp, 8x39mm, 210mm, 8^{1/4}"

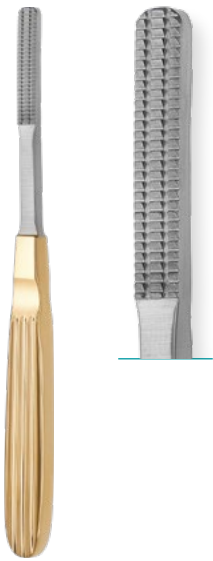

ORIGINAL MALTZ

TC Nasal Rasp, 180mm, 7"

Backward cutting	420-672-000
Forward cutting	420-672-004



GLABELLA

TC Nasal Rasp, 210mm, 8¹/₄"

Coarse	420-668-210
Medium	420-669-210



AUFRICHT (PEET)

Nasal Rasp, fine, curved, 25x7mm, diamond dusted

210mm, 8 ¹ / ₄ "	420-650-101
--	-------------



PEET-COTTLE

Nasal Rasp, curved, RZ diamonds, 190mm, 7¹/₂"

Curved	420-650-100
Straight	420-650-050



FOMON

Rasp, coarse, convex on flat, 40x7mm, diamond dusted

210mm, 8 ¹ / ₄ "	420-653-000
--	-------------

Diamond dusted rasps are mainly used for final finishing.

Double-ended Nasal Rasps



FRIEDMAN
Nasal Rasp, coarse, round/flat

210mm, 8¹/₄"

420-677-210



FOMON
Rasp, coarse, round/flat

215mm, 8¹/₂"

420-660-000

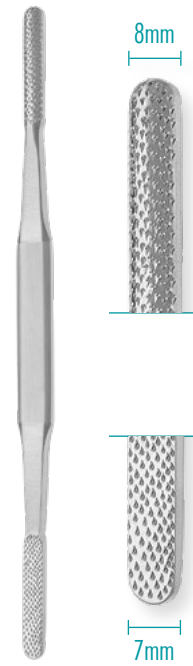

FOMON
Rasp, fine, round/flat

215mm, 8¹/₂"

420-661-000

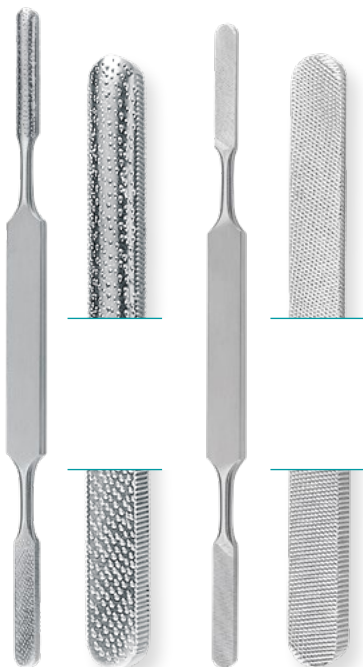

FOMON
Rasp, 4 sides, round/flat, fine/course

210mm, 8¹/₄"

420-661-100

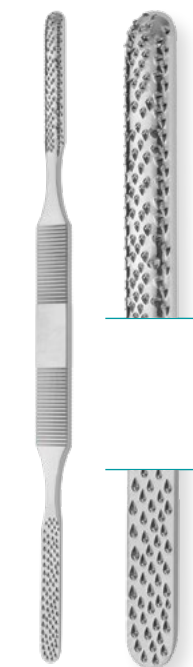

FOMON
Rasp, coarse, lightweight handle design

215mm, 8¹/₂"

420-662-001

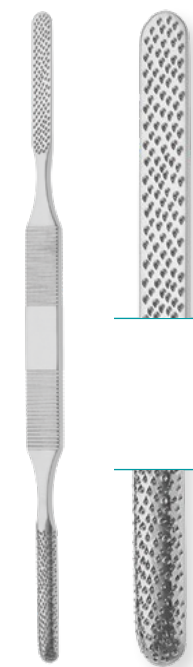

FOMON
Rasp, fine, lightweight handle design

215mm, 8¹/₂"

420-662-002



BARSKY-GLABELLA
Nasal Rasp, backward cutting, curved

175mm, 6 ⁷ / ₈ "	420-756-180
--	-------------



MCINDOE
Nasal Rasp, straight, 180mm, 7"

Backward cutting	420-655-180
Forward cutting	420-656-180

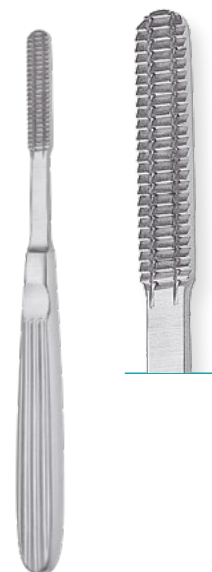

ORIGINAL MALTZ
Nasal Rasp, straight, 165mm, 6¹/₂"

Backward cutting	420-654-180
Forward cutting	420-657-180

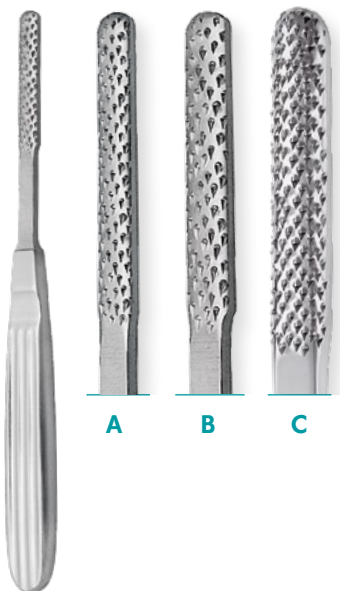

LAMONT
Nasal Rasp, backward cutting, straight, 175mm, 6⁷/₈"

A Delicate	420-690-200
B Standard	420-691-200
C Wide	420-692-200



AUFRICHT
Nasal Rasp, curved, 220mm, 8³/₄"

Forward cutting	420-650-001
Backward cutting	420-650-002



COTTLE
Nasal Rasp, backward cutting, straight

210mm, 8 ¹ / ₄ "	420-670-210
--	-------------



GALLAHER
Nasal Rasp, with ring, coarse

170mm, 6²/₃" 420-678-190



WATSON-WILLIAMS
Nasal Rasp, convex blade, knee bent, 170mm, 6²/₃"

Fine 420-520-170
Coarse 420-521-170

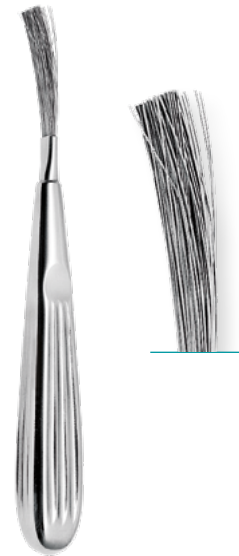

Wire Brush for cleaning Rasps

165mm, 6¹/₂" 260-500-001

FOMON MODULAR Nasal Rasp System



420-660-200 Fomon Nasal Rasp Holder, double-ended



420-660-100 Fomon Nasal Rasp Holder, single ended

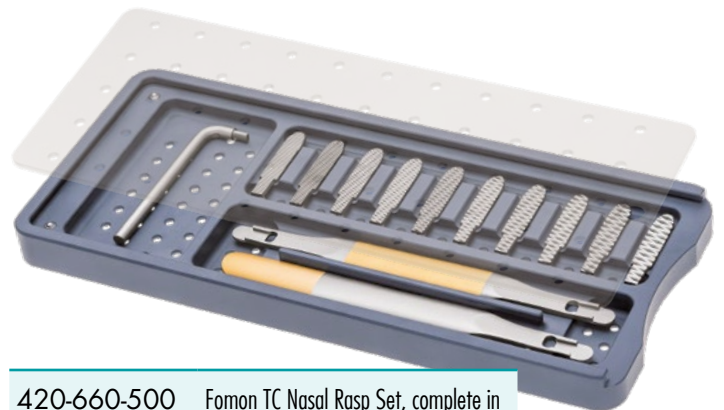

420-660-500 Fomon TC Nasal Rasp Set, complete in sterilization tray, incl. 10 inserts, 1 key and 2 handles (single+double)



420-660-101 Fomon TC Insert, Fig. 1



420-660-102 Fomon TC Insert, Fig. 2



420-660-103 Fomon TC Insert, Fig. 3

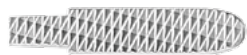

420-660-104 Fomon TC Insert, Fig. 4



420-660-105 Fomon TC Insert, Fig. 5



420-660-106 Fomon TC Insert, Fig. 6



420-660-107 Fomon TC Insert, Fig. 7



420-660-108 Fomon TC Insert, Fig. 8



420-660-109 Fomon TC Insert, Fig. 9



420-660-110 Fomon TC Insert, Fig. 10

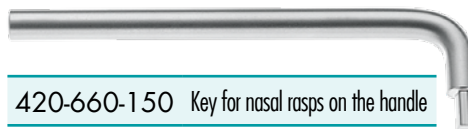

420-660-150 Key for nasal rasps on the handle

CHISELS & OSTEOTOMES



Osteotomes

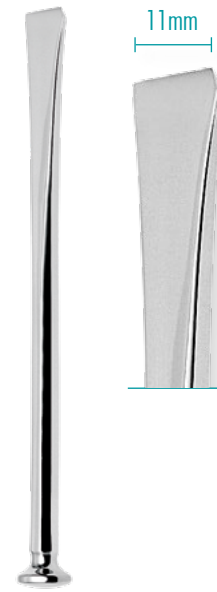
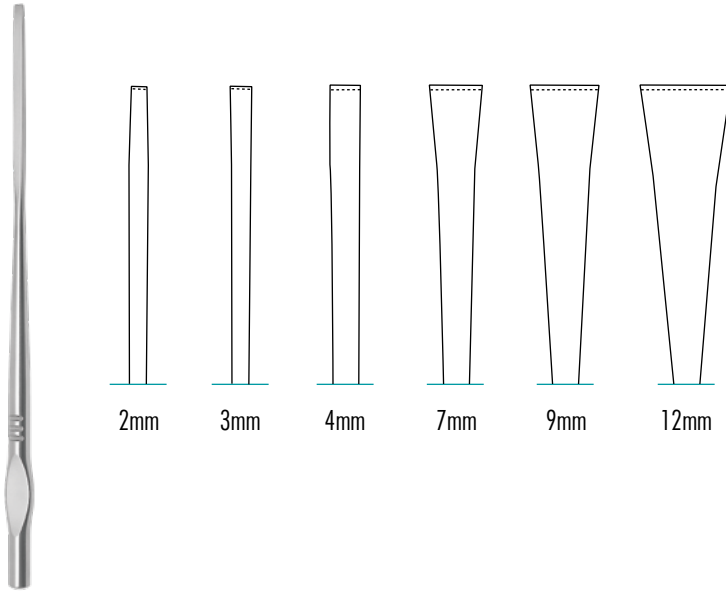

WALTER

Osteotome, 190mm, 7^{1/2}"

2mm	420-580-002	7mm	420-580-007
3mm	420-580-003	9mm	420-580-009
4mm	420-580-004	12mm	420-580-012

MATTHEW

Osteotome, 180mm, 7"

11mm	420-503-011
------	-------------

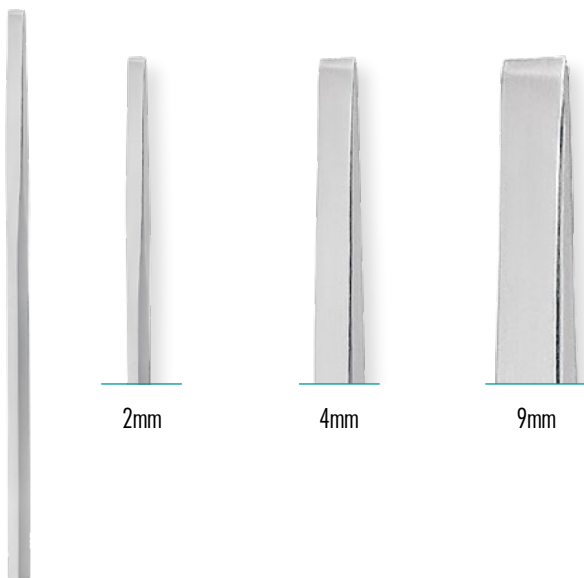

SHEEHAN

Osteotome, 175mm, 6^{3/4}"

2mm	420-594-002	9mm	420-594-009
3mm	420-594-003	10mm	420-594-010
4mm	420-594-004	11mm	420-594-011
5mm	420-594-005	12mm	420-594-012
6mm	420-594-006	15mm	420-594-015
8mm	420-594-008		

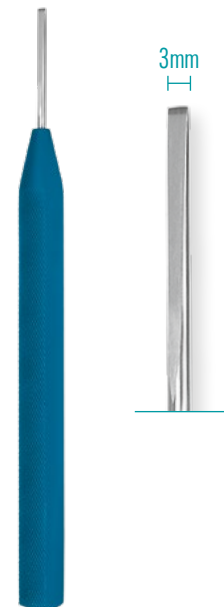

REES

Osteotome, 200mm, 8", with aluminum handle

3.0 mm	420-500-200
--------	-------------

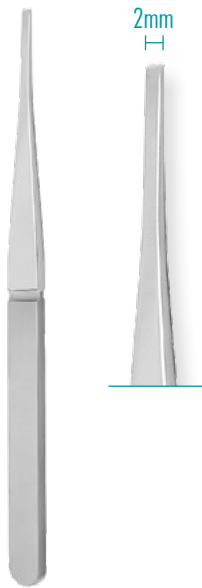

RZ
Osteotome, 180mm, 7"

2mm	420-568-002	8mm	420-568-008
4mm	420-568-004	10mm	420-568-010
6mm	420-568-006		

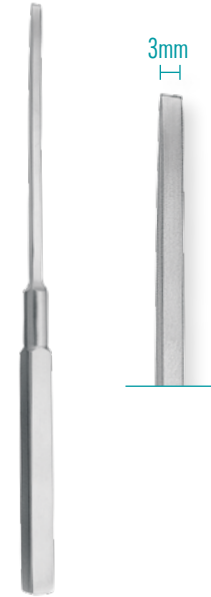

WARD
Osteotome, 180mm, 7"

3mm	420-495-003
4mm	420-495-004
5mm	420-495-005

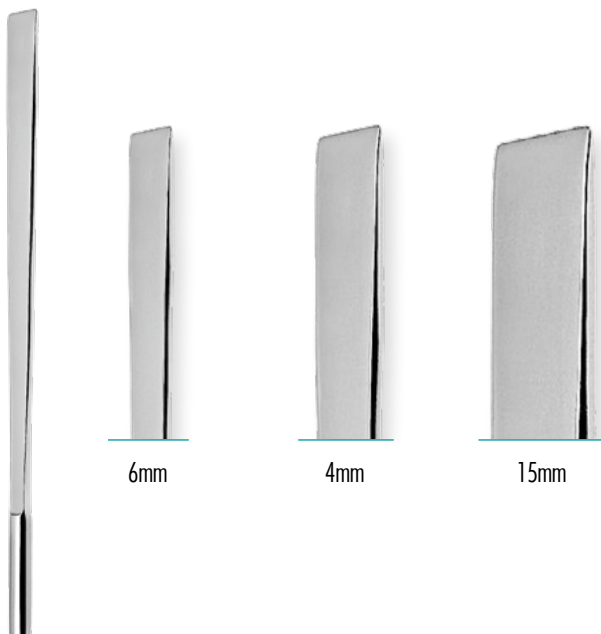

JAYES
Osteotome, 190mm, 7¹/₂"

2mm	420-501-002	10mm	420-501-010
4mm	420-501-004	12mm	420-501-012
6mm	420-501-006	15mm	420-501-015
8mm	420-501-008		



ROZNER
Osteotome, double guarded on the inclined cutting edge

180mm, 7"	420-507-010
-----------	-------------



14mm

RUBIN

Osteotome, 167mm, 6¹/₂" , 8mm wide

8mm	420-587-008
10mm	420-587-010
12mm	420-587-012
14mm	420-587-014
16mm	420-587-016

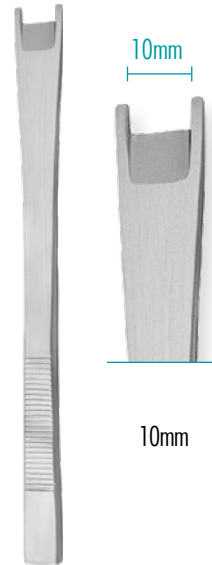

10mm

10mm

CINELLI

Osteotome, double guarded, 160mm, 6¹/₄"

8mm	420-589-008
10mm	420-589-010
12mm	420-589-012
14mm	420-589-014
16mm	420-589-016



4mm

4mm

OBWEGESER

Osteotome, buttoned, U-shape cutting edge, 185mm, 7¹/₄"

4mm	431-662-190
6mm	431-666-190
8mm	431-668-190



4mm

OBWEGESER

Osteotome, with V-tip, 175mm, 6³/₄"

Straight	420-460-004
Curved	420-460-005



6mm

EPKER

Osteotome, straight, 180mm, 7"

4mm	420-498-004
6mm	420-498-006
8mm	420-498-008



SILVER

Osteotome, with guard, 180mm, 7"

Straight	420-459-001
Right curved	420-459-002
Left curved	420-459-003

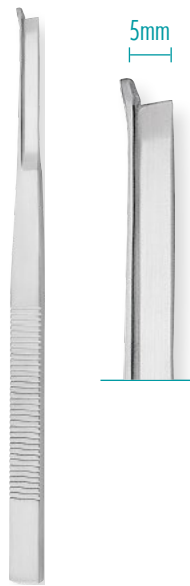

MASING

Osteotome, with guard, 180mm, 7"

Straight	420-459-101
Right curved	420-459-102
Left curved	420-459-103

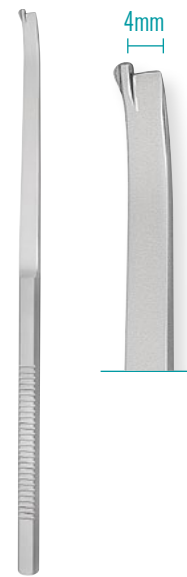

ANDERSON-NEIVERT

Osteotome, with guard, 180mm, 7"

Straight	420-639-001
Right curved	420-639-002
Left curved	420-639-003



FRENCHAY

Osteotome, with guard, 180mm, 7"

Straight	420-491-000
Right curved	420-491-002
Left curved	420-491-001



FANOUS-GUBISCH

Osteotome, straight, 4mm wide, 200mm, 8" with guard

Straight	420-640-001
Right curved	420-640-002
Left curved	420-640-003



BRAITHWAITE

Nasal Chisel, 5mm wide, 145mm, 5³/₄"

Guard left	420-485-005
Guard right	420-486-005
Without guard	420-487-005

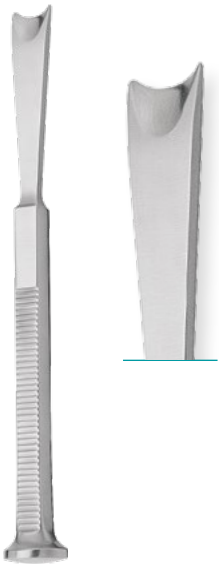

MCINDOE

Nasal Chisel with Mushroom head, 150mm, 6"

9mm	420-487-009
11mm	420-487-011
13mm	420-487-013
15mm	420-487-015



KILLIAN

Septum Gouge, round cutting edge, 170mm, 6³/₄"

6mm	420-552-170
-----	-------------

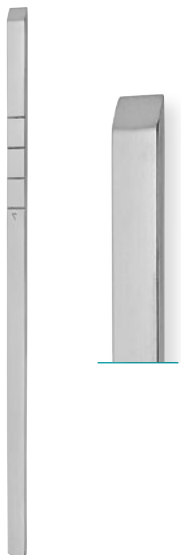

COTTLE

Chisel, graduated, 185mm, 7¹/₄"

4mm	210-488-004	8mm	210-488-008
6mm	210-488-006	9mm	210-488-009
7mm	210-488-007	12mm	210-488-012

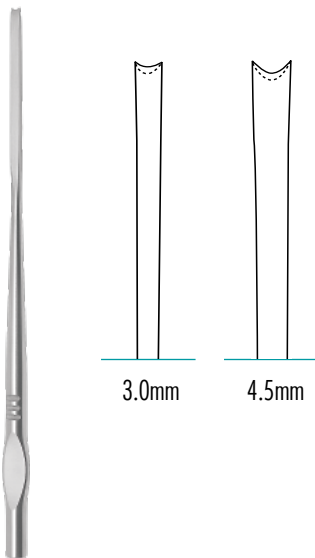
**WALTER**

Chisel with notch, double guarded, 190mm, 7¹/₂"

3.0mm	420-582-003
4.5mm	420-582-045

**KILLIAN-CLAUS**

Septum Gouge, notched cutting edge, 170mm, 6³/₄"

6mm	420-551-170
-----	-------------

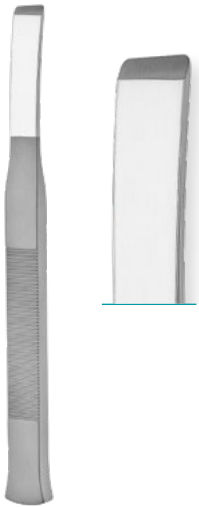

TESSIER

Osteotome, straight, 160mm, 6¹/₄"

2mm	420-502-002	10mm	420-502-010
3mm	420-502-003	15mm	420-502-015
5mm	420-502-005	18mm	420-502-018
7mm	420-502-007		



TESSIER

Osteotome, curved, 200mm, 8"

10mm	420-502-211
15mm	420-502-216



TESSIER

Osteotome, straight, 200mm, 8"

10mm	420-502-210
15mm	420-502-215

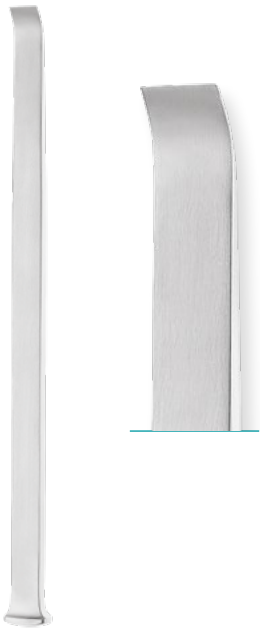

OBWEGESER

Osteotome, curved, 230mm, 9"

8mm	431-643-008
11mm	431-643-011



OBWEGESER

Osteotome, thin blade, 220mm, 8³/₄"

8mm	431-645-008
12mm	431-645-012
16mm	431-645-016



OBWEGESER-RAMUS

Osteotome, wedge-shaped, 220mm, 8³/₄"

8mm	431-646-008
12mm	431-646-012
16mm	431-646-016



OBWEGESER

Osteotome, tapered, 220mm, 8³/₄"

7mm	431-645-007
10mm	431-645-010

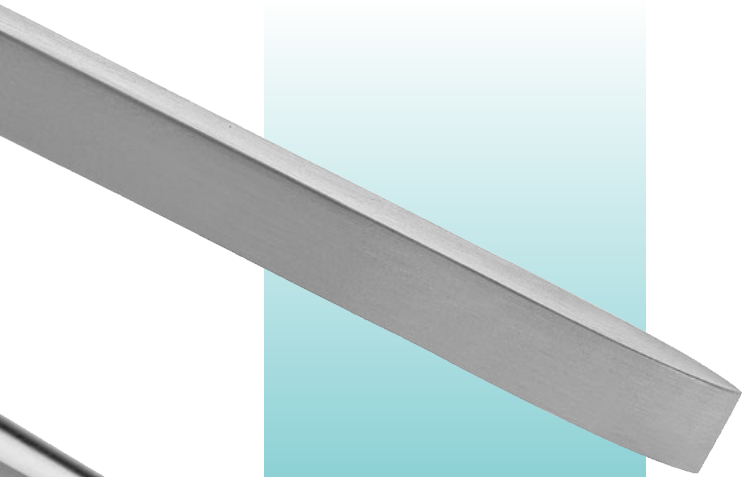

OSTEOTOME



CHISEL

ADVANCED RHINOPLASTIC SET

420-990-004





Micro Osteotome
185mm, 7¹/₄"

2.0mm	420-700-020
2.5mm	420-700-025
3.0mm	420-700-030

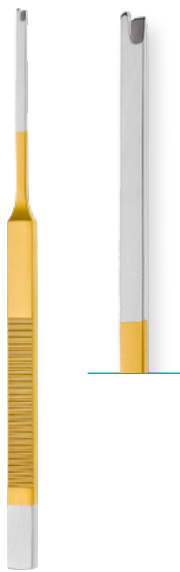

Micro Osteotome
with guard, 185mm, 7¹/₄"

2.2mm	420-700-022
-------	-------------



Micro Osteotome
185mm, 7¹/₄"

10mm	420-700-100
12mm	420-700-120
14mm	420-700-140



JOSEPH
Periosteal Elevator, 180mm, 7"

3mm	420-700-430
-----	-------------



Skin Hook
2 prongs, 10mm wide

120mm, 4 ³ / ₄ "	420-700-210
--	-------------



Micro Skin Hook
155mm, 6"

1 prong	420-700-001
2 prongs	420-700-002



Glabella Rasp
8mm wide

185mm, 7¹/₄"

420-700-400

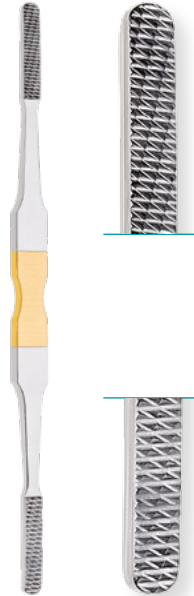

TC Nasal Rasp
double-ended, 200mm, 7³/₄"

Medium

420-700-501

Medium & fine

420-700-502



AUFRICT

Nasal Retractor, 160mm, 6¹/₄"

160mm, 6¹/₄"

420-700-200

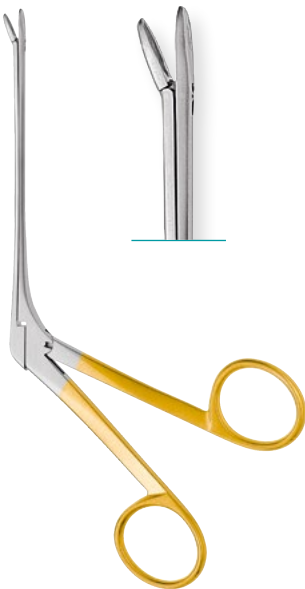

BLAKESLEY

Nasal Forceps, delicate, 110mm, 4¹/₂"

110mm, 4¹/₂"

420-700-700



HALSEY

TC Needle Holder, 130mm, 5"

130mm, 5"

420-700-330



KILNER
Dissecting Scissors

140mm, 5¹/₂"

420-700-340



Rhinoplasty Scissors
sharp, 100mm, 4"

Straight

420-700-610

Curved

420-700-611



WALTER
Scissors, angled

100mm, 4"

420-700-620



ADSON-BROWN
Tissue Forceps, lateral grasping teeth with 7x7 brown teeth

120mm, 4³/₄"

420-700-630



ADSON
Dressing Forceps

120mm, 4³/₄"

420-700-640



ADSON
Tissue Forceps, 1x 2 teeth

120mm, 4³/₄"

420-700-650

MALLETS





Weight	240g
Diameter	30mm

COTTLE
Mallet, with plain and convex side

190mm, 7 ¹ / ₂ "	210-240-180
--	-------------



Weight	140g
Diameter	25mm

BERGMANN
Mallet, with exchangeable plastic discs

185mm, 7 ¹ / ₄ "	210-264-140
--	-------------

Spare plastic discs

One pair	210-265-000
----------	-------------



Weight	320g
Diameter	27mm

MEAD
Mallet, with exchangeable plastic discs

190mm, 7 ¹ / ₂ "	210-262-170
--	-------------

Spare plastic discs

One pair	210-263-000
----------	-------------



Weight	130g
Diameter	27mm

HAJEK
Mallet

220mm, 8 ³ / ₄ "	210-244-220
--	-------------



Weight	117g
Diameter	19mm

RZ
Mallet, with copper head

170mm, 6 ² / ₃ "	210-019-170
--	-------------

NASAL SPECULA

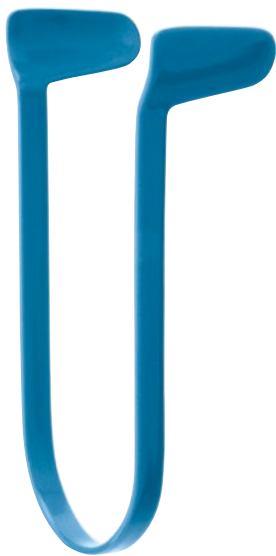



THUDICHUM (MARK HOVELL)
Nasal Speculum, non-insulated

Blade size	Total length	Order Number
8.5 x 6mm	70mm	420-050-001
9 x 7mm	70mm	420-050-002
12.5 x 8mm	70mm	420-050-003
15 x 8.5mm	70mm	420-050-004
16.5 x 9mm	70mm	420-050-005
18 x 10mm	70mm	420-050-006
19.5 x 10.5mm	70mm	420-050-007



THUDICHUM (MARK HOVELL)
Nasal Speculum, insulated

Blade size	Total length	Order Number
8.5 x 6mm	70mm	420-050-101
9 x 7mm	70mm	420-050-102
12.5 x 8mm	70mm	420-050-103
15 x 8.5mm	70mm	420-050-104
16.5 x 9mm	70mm	420-050-105
18 x 10mm	70mm	420-050-106
19.5 x 10.5mm	70mm	420-050-107

8.5 x 6 mm

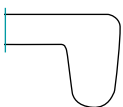

9 x 7 mm

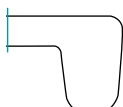

12.5 x 8 mm

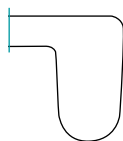

15 x 8.5mm

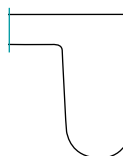

16.5 x 9 mm

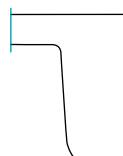

18 x 10mm

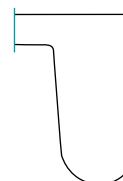

19.5 x 10.5mm

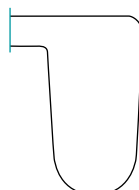



ST.CLAIR THOMPSON
Nasal Speculum

Blade length	Total length	Order Number
38mm	73mm	420-052-001
50mm	73mm	420-052-002
65mm	73mm	420-052-003
75mm	73mm	420-052-004

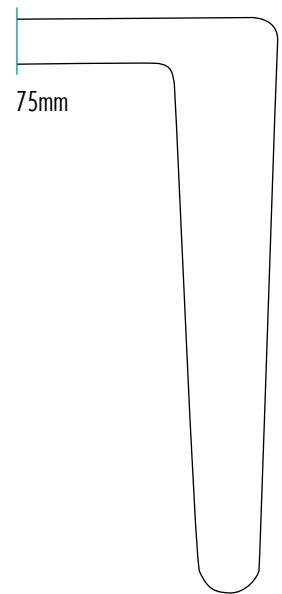
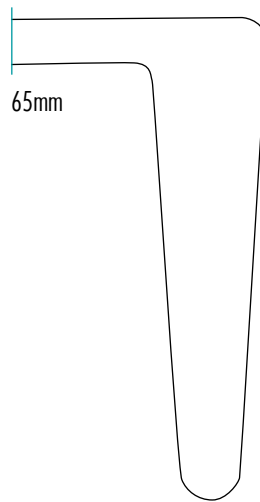
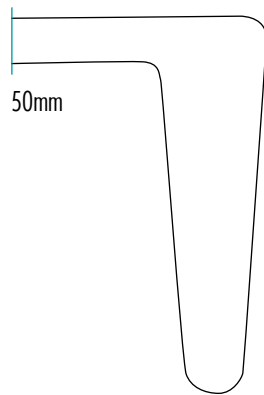
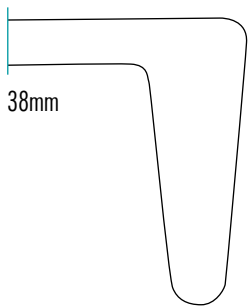

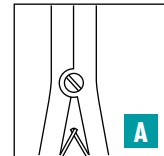

Blade length	Total length	A - Without locking screw
28mm	140mm	420-100-001
30mm	140mm	420-100-002
32mm	140mm	420-100-003

WIENER MODELL
Nasal Speculum, screw joint

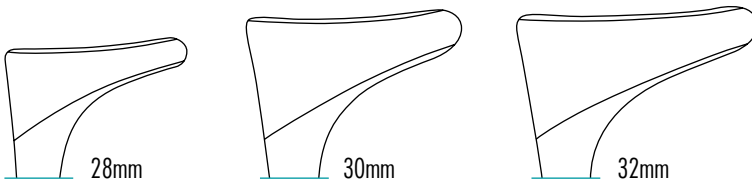

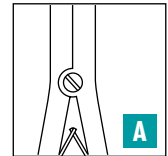

Blade length	Total length	A - Without locking screw
29mm	155mm	420-120-150
31mm	155mm	420-122-150
37mm	155mm	420-123-150

HARTMANN-HALLE

Nasal Speculum, tapered blade, screw joint

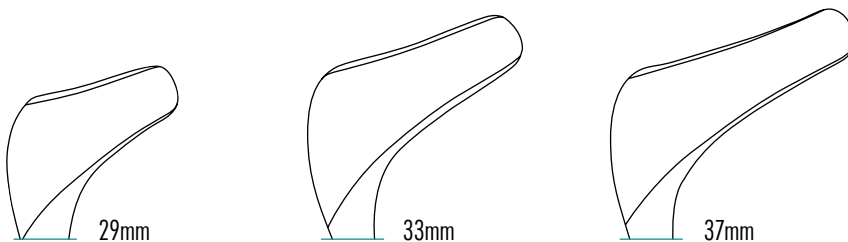

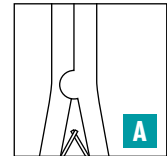

Blade length	Total length	A - Without locking screw
29mm	155mm	420-124-029
33mm	155mm	420-124-033
37mm	155mm	420-124-037

HARTMANN-HALLE
Nasal Speculum, tapered blade, aseptic joint

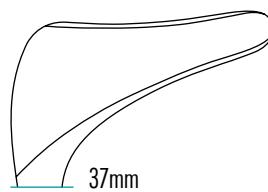
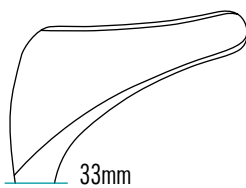
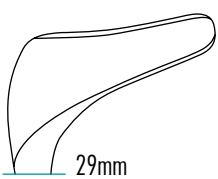

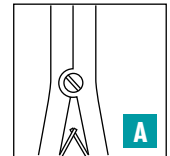

Blade length	Total length	A - Without locking screw
29mm	160mm	420-119-001
33mm	160mm	420-119-002
35mm	160mm	420-119-003

HARTMANN
Nasal Speculum, screw joint

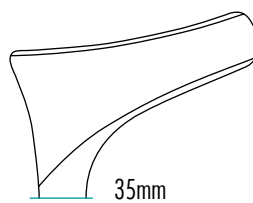
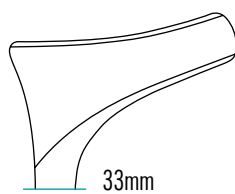
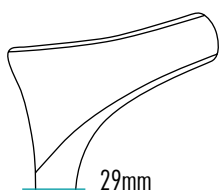

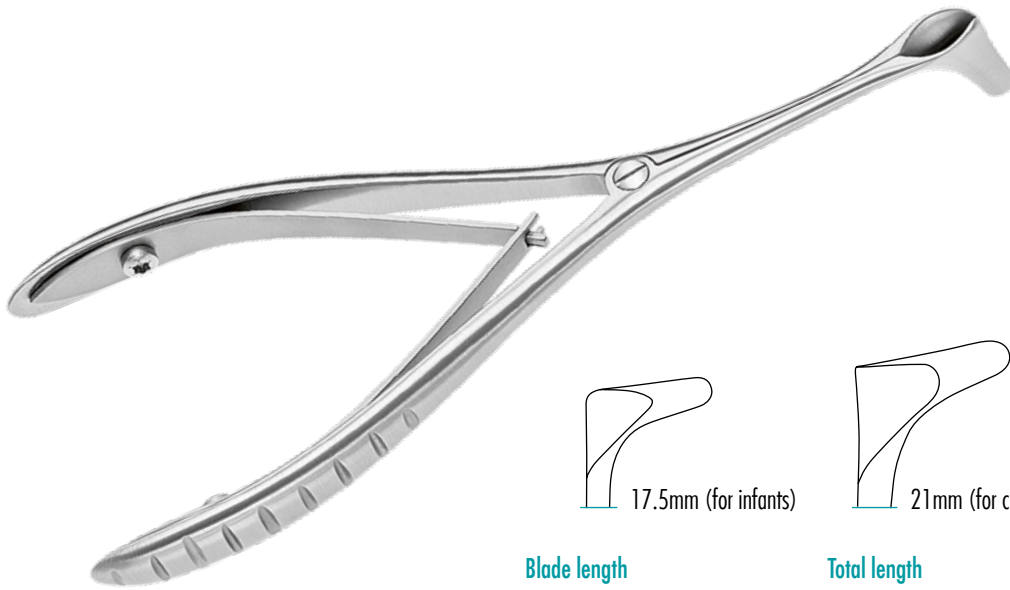

HALLE-TIECK
Nasal Speculum, screw joint

Blade length	Total length	A - Without locking screw
17.5mm (for infants)	130mm	420-140-135
21mm (for children)	130mm	420-142-135

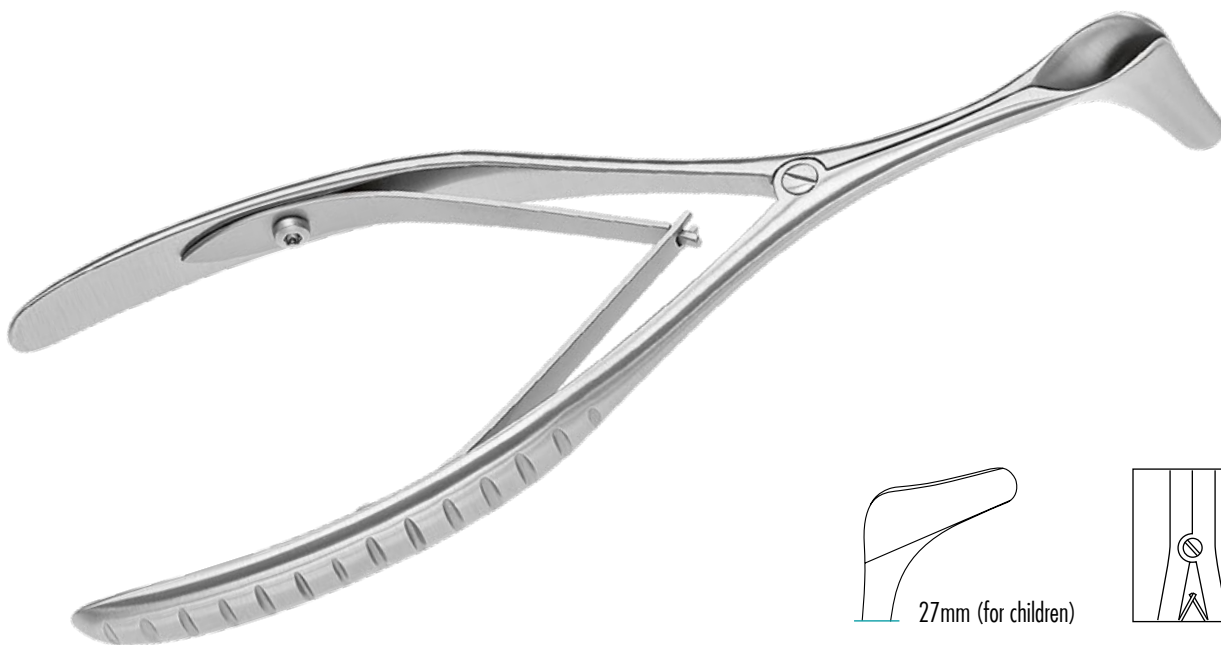

HARTMANN-HALLE MOD. SONNENSCHN
Nasal Speculum, screw joint

Blade length	Total length	A - Without locking screw
27mm (for children)	150mm	420-150-150

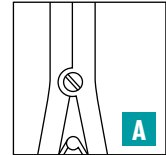
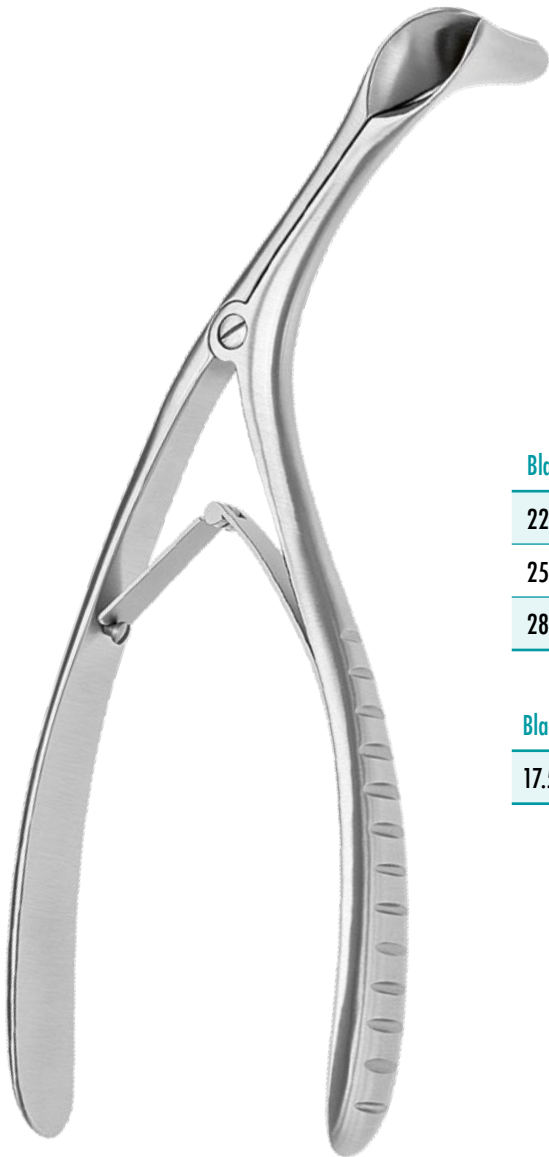

Blade length	Total length	A - Without locking screw
22mm	150mm	420-148-150
25mm	150mm	420-146-152
28mm	155mm	420-146-153

Blade length	Total length	A - Without locking screw
17.5mm (for infants)	130mm	420-147-140

BECKMANN
Nasal Speculum, screw joint

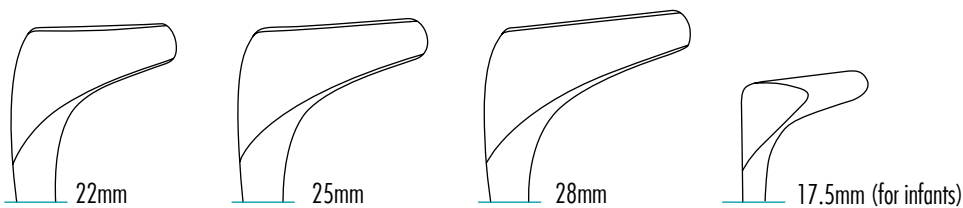

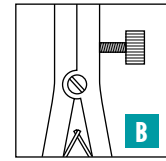
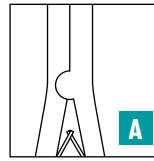
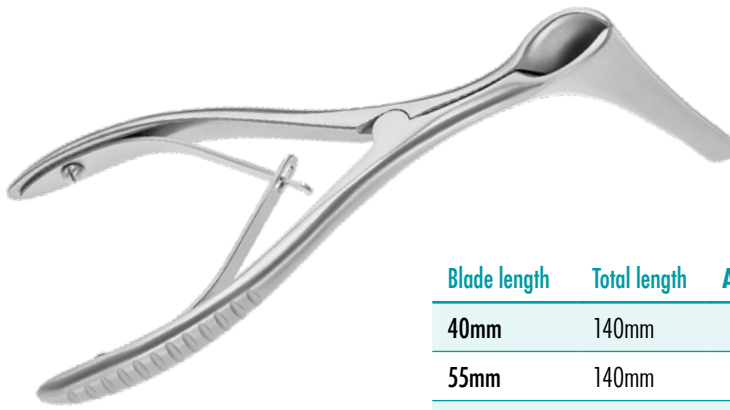

Blade length	Total length	A - Without locking screw, aseptic joint	B - With locking screw, screw joint
40mm	140mm	420-143-040	420-148-040
55mm	140mm	420-143-055	420-148-055
75mm	140mm	420-143-075	420-148-075
90mm	140mm	420-143-090	420-148-090

KILLIAN STANDARD
Nasal Speculum

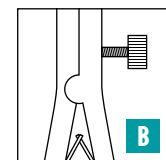
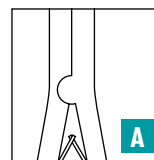
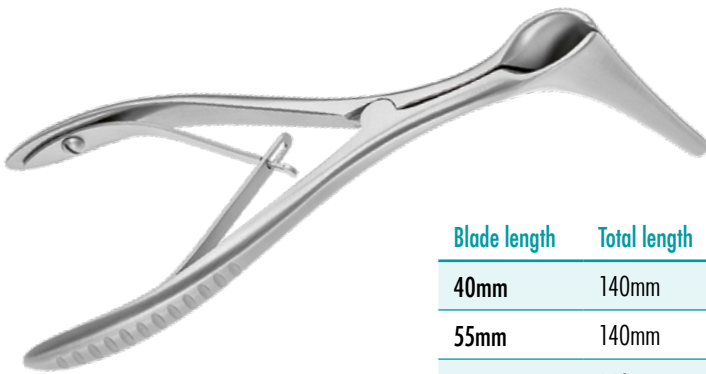
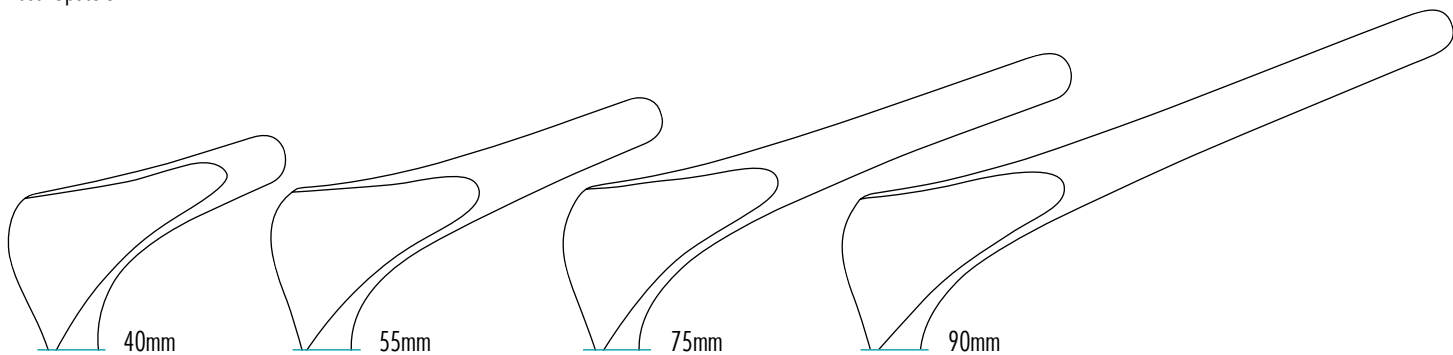

Blade length	Total length	A - Without locking screw	B - With locking screw
40mm	140mm	420-144-040	420-141-040
55mm	140mm	420-144-055	420-141-055
75mm	140mm	420-144-075	420-141-075
90mm	140mm	420-144-090	420-141-090

KILLIAN
Nasal Speculum, tapered blades, aseptic joint

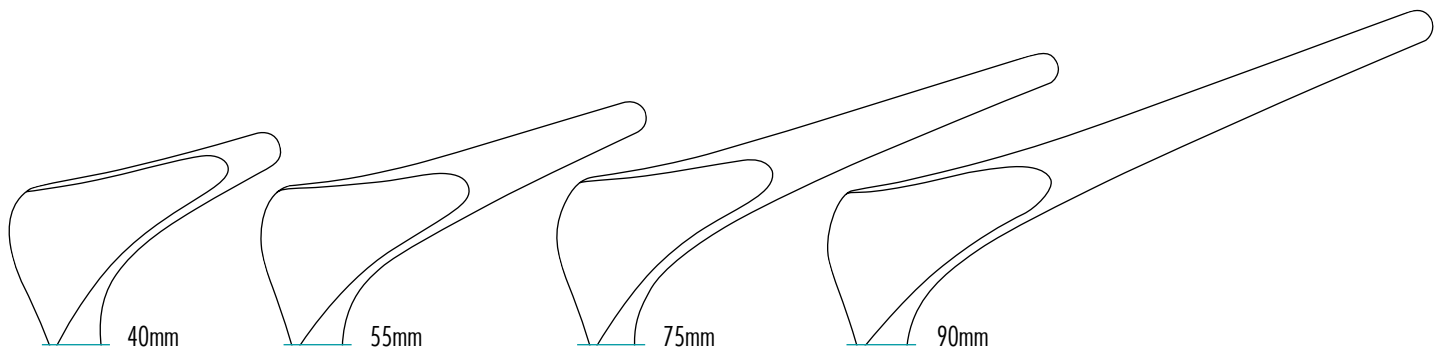

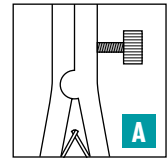
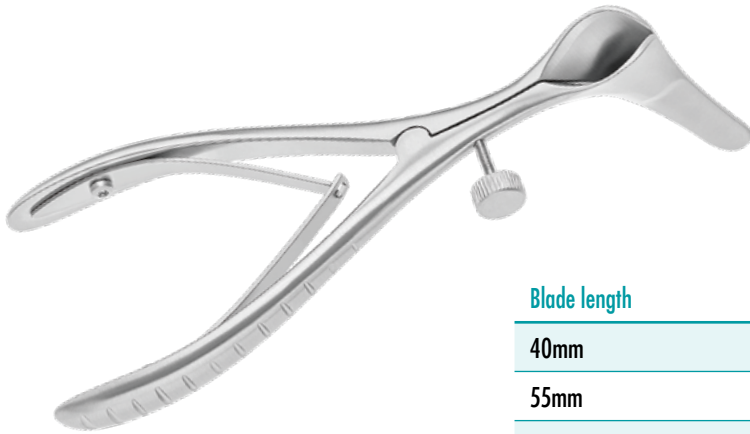

Blade length	Total length	A - With locking screw
40mm	140mm	420-138-040
55mm	140mm	420-138-055
75mm	140mm	420-138-075
90mm	140mm	420-138-090

KILLIAN-WALTER
Nasal Speculum, thin blades, aseptic joint

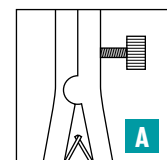
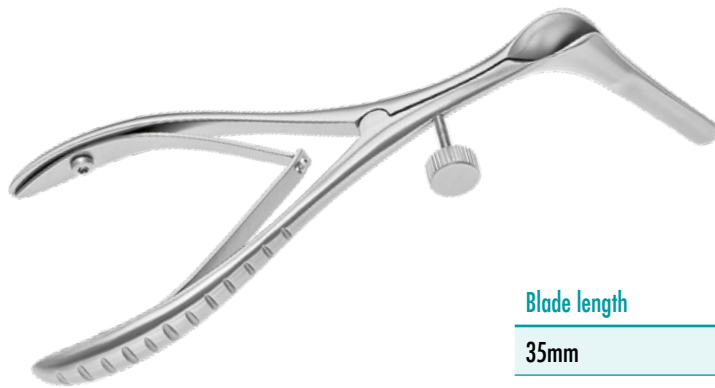
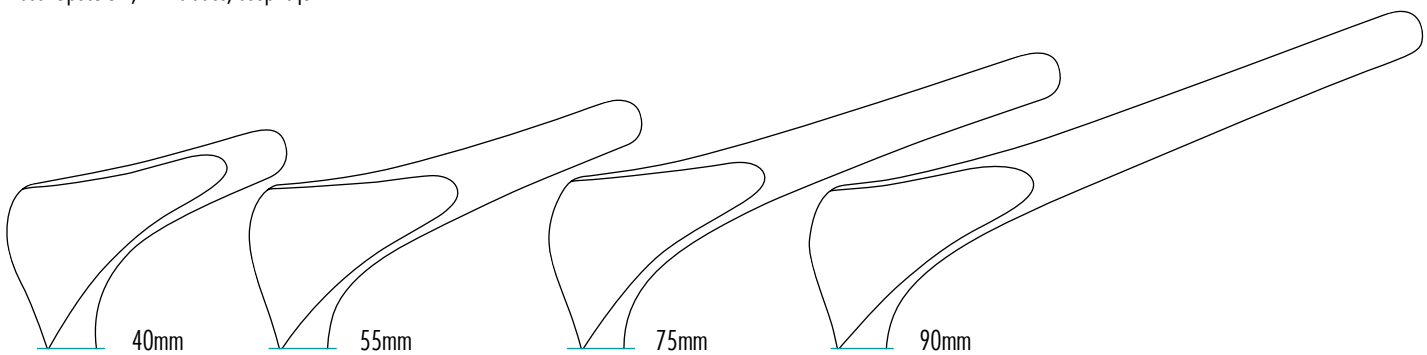

Blade length	Total length	A - With locking screw
35mm	130mm	420-139-035
55mm	130mm	420-139-055
75mm	130mm	420-139-075

WALTER
Nasal Speculum, very thin blade, aseptic joint

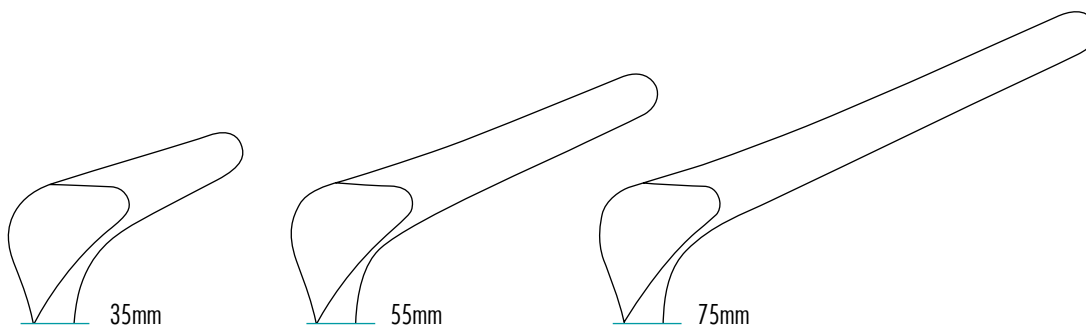

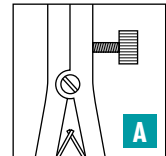

Blade length	Total length	A - With locking screw
30mm	135mm	420-136-020
38mm	135mm	420-136-035
55mm (tapered blade)	140mm	420-134-050
55mm	135mm	420-136-055
70mm	135mm	420-136-070
80mm	135mm	420-136-080
90mm	140mm	420-136-090

KILLIAN-COTTLE
Nasal Speculum, screw joint

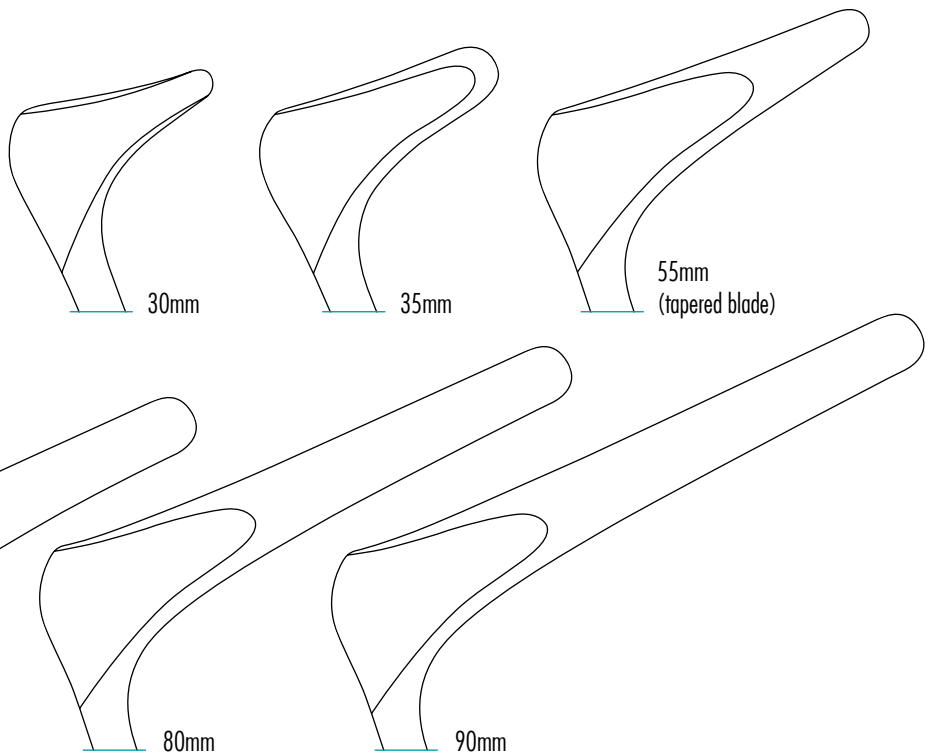

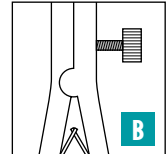
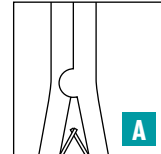

Blade length	Total length	A - Without locking screw	B - With locking screw
40mm	140mm	420-147-040	420-146-040
55mm	140mm	420-147-055	420-146-055
75mm	140mm	420-147-075	420-146-075
90mm	140mm	420-147-090	420-146-090

KILLIAN-STRUYCKEN
Nasal Speculum, aseptic joint

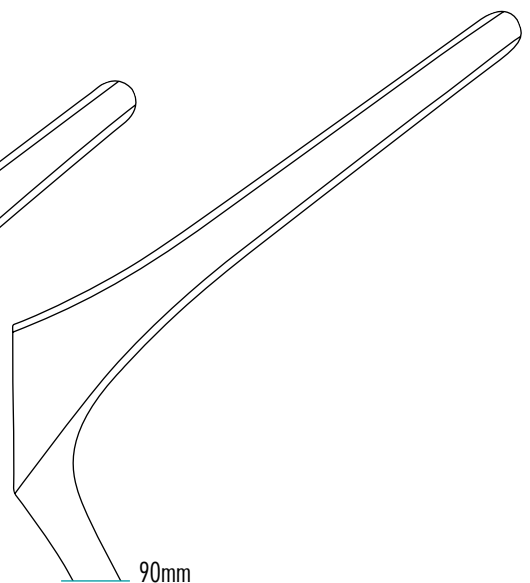
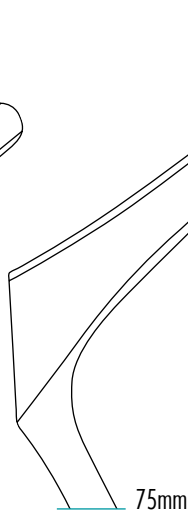
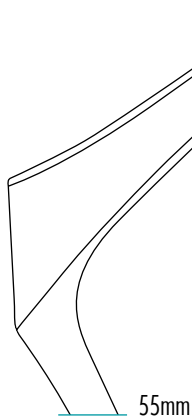
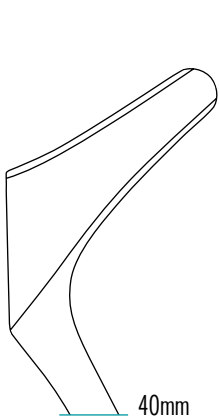

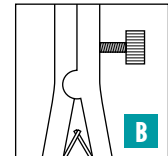
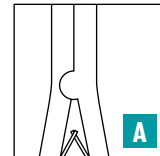

Blade length	Total length	A - Without locking screw	B - With locking screw
35mm	130mm	420-132-035	420-135-035
50mm	130mm	420-132-055	420-135-055
75mm	130mm	420-132-075	420-135-075
90mm	130mm	420-132-090	420-135-090

COTTLE
Nasal Speculum, aseptic joint

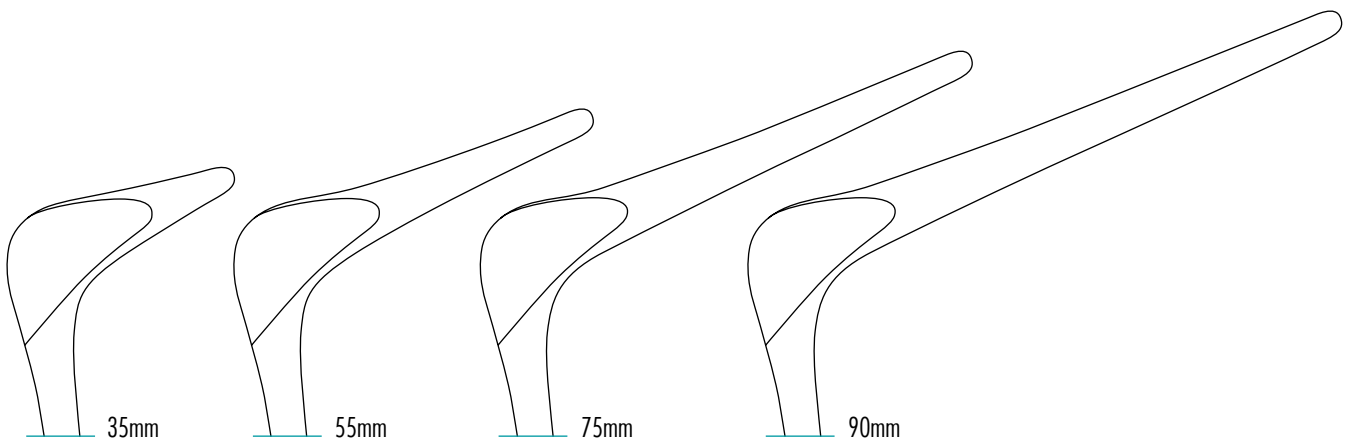

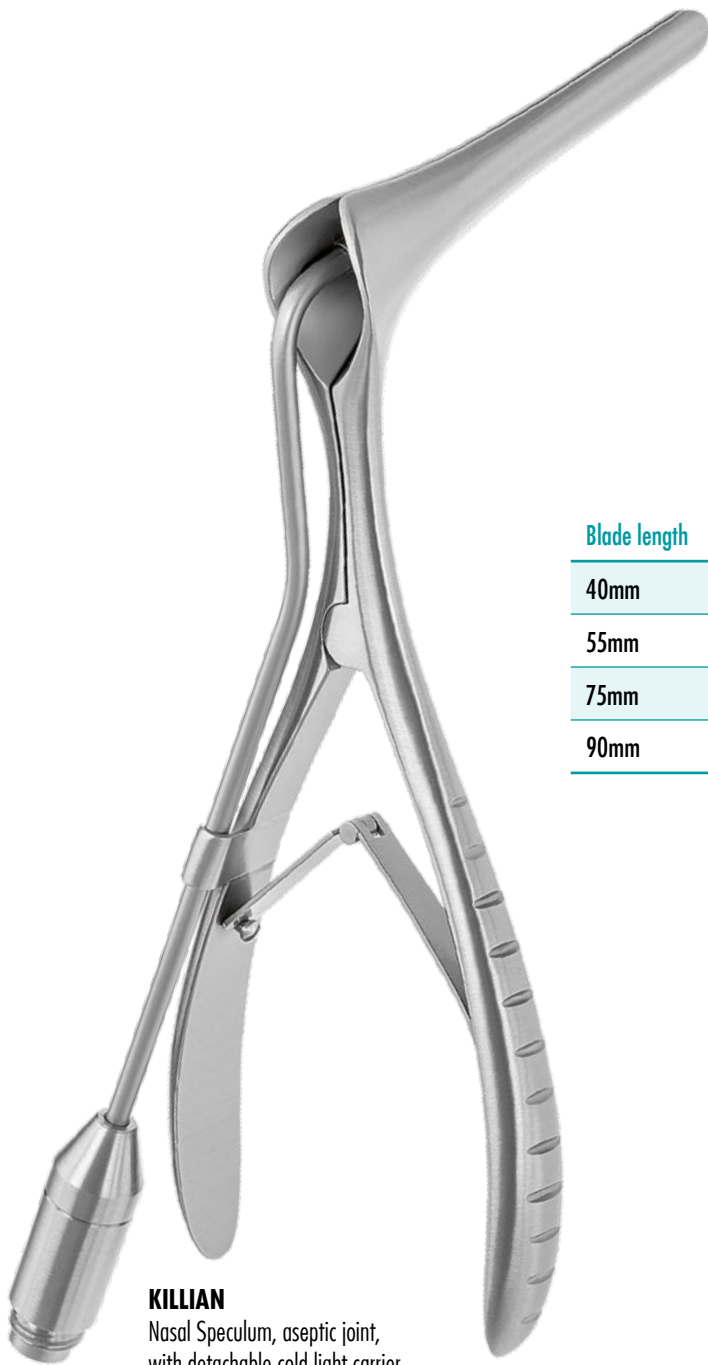

KILLIAN
Nasal Speculum, aseptic joint,
with detachable cold light carrier

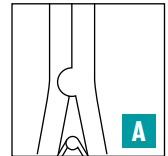

Blade length	Total length	A - Without locking screw
40mm	140mm	420-743-040
55mm	140mm	420-743-055
75mm	140mm	420-743-075
90mm	140mm	420-743-090

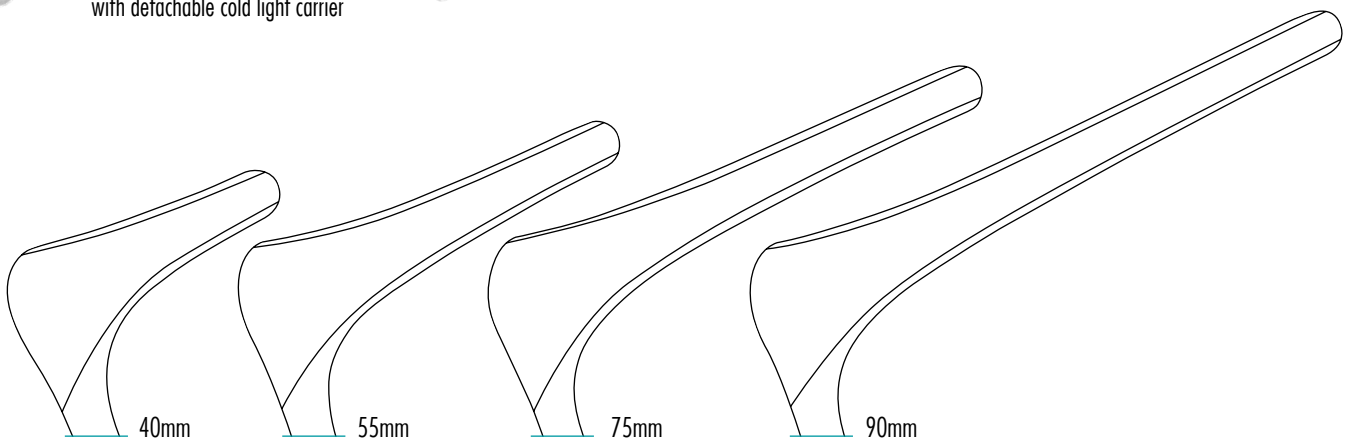

For use with fibre-optic cables (see page 248).

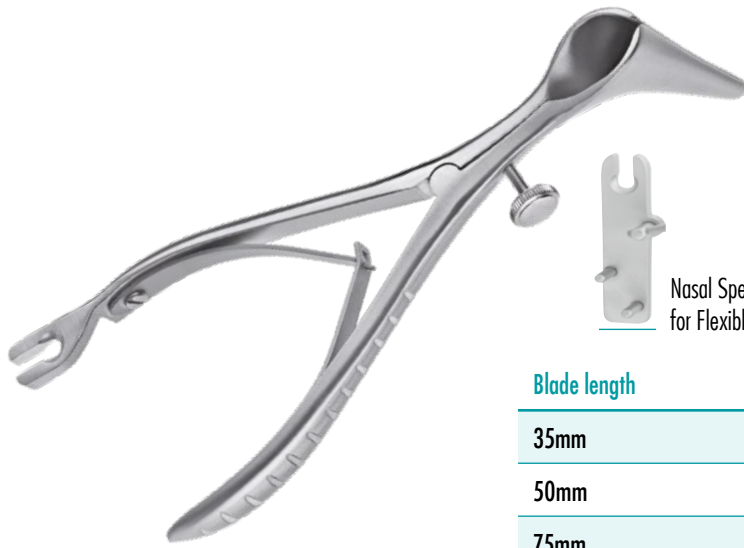

Nasal Specula Clamp for Flexible Arm



Flexible Arm complete with holding rod

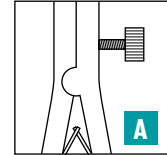

COTTLE-MASING

Nasal Speculum, aseptic joint, for flexible arm

Blade length	Total length	A - With locking screw
35mm	140mm	420-140-035
50mm	140mm	420-140-050
75mm	140mm	420-140-075
90mm	140mm	420-140-090
100mm	140mm	420-140-100
Flexible Arm complete with holding rod		251-010-000
Nasal Specula Clamp for Flexible Arm		251-010-400

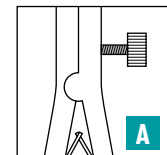
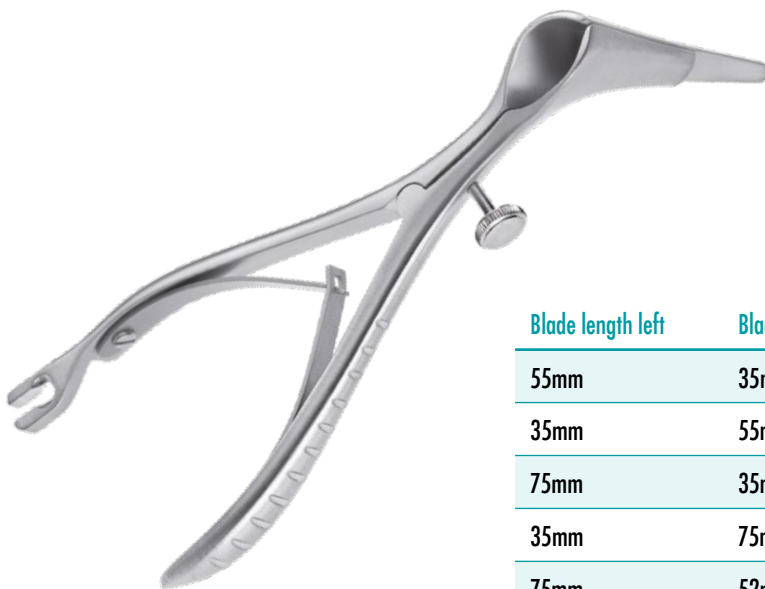

SINUS

Nasal Speculum, aseptic joint, for flexible arm

Blade length left	Blade length right	Total length	A - With locking screw
55mm	35mm	140mm	420-150-101
35mm	55mm	140mm	420-150-102
75mm	35mm	140mm	420-150-105
35mm	75mm	140mm	420-150-106
75mm	52mm	140mm	420-150-107
52mm	75mm	140mm	420-150-108
Flexible Arm complete with holding rod			251-010-000
Nasal Specula Clamp for Flexible Arm			251-010-400



Sinus
Nasal Speculum, with teeth,
aseptic joint, for flexible arm

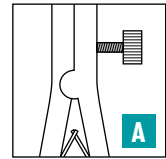

Blade length left	Blade length right	Total length	A - With locking screw
55mm	35mm	140mm	420-150-001
35mm	55mm	140mm	420-150-002
65mm	45mm	140mm	420-150-003
45mm	65mm	140mm	420-150-004
75mm	35mm	140mm	420-150-005
35mm	75mm	140mm	420-150-006
75mm	52mm	140mm	420-150-007
52mm	75mm	140mm	420-150-008
Flexible Arm complete with holding rod			251-010-000
Nasal Specula Clamp for Flexible Arm			251-010-400

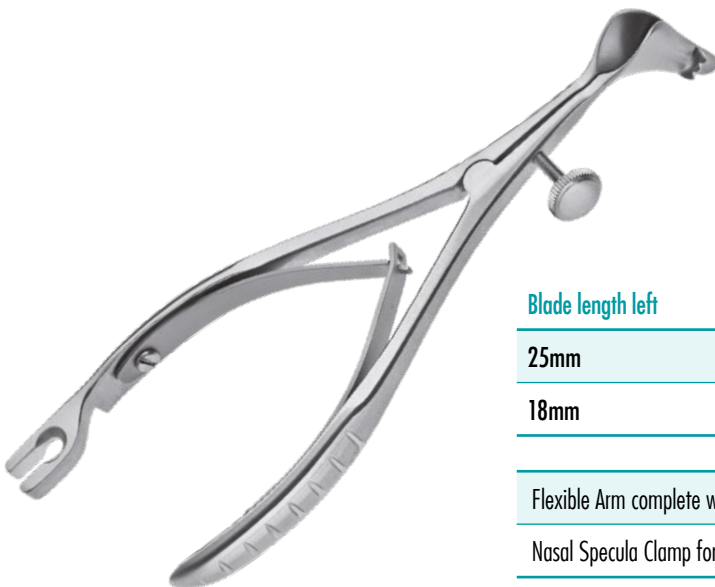

Sinus
Nasal Speculum, for children,
with teeth, aseptic joint,
for flexible arm

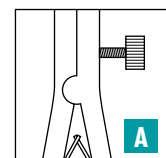

Blade length left	Blade length right	Total length	A - With locking screw
25mm	18mm	140mm	420-150-301
18mm	25mm	140mm	420-150-302
Flexible Arm complete with holding rod			251-010-000
Nasal Specula Clamp for Flexible Arm			251-010-400

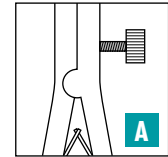
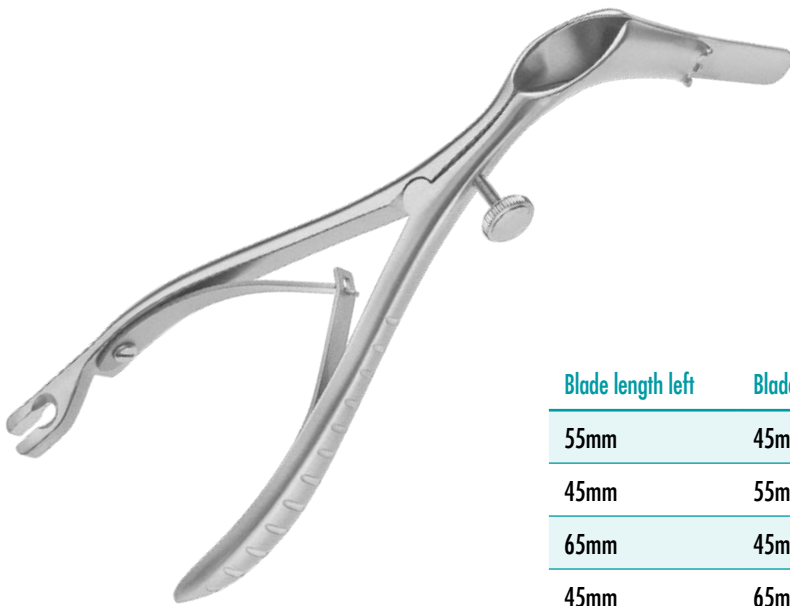

Killian-Struycken Sinus
Nasal Speculum, with teeth,
aseptic joint, for flexible arm

Blade length left	Blade length right	Total length	A - With locking screw
55mm	45mm	150mm	420-150-201
45mm	55mm	150mm	420-150-202
65mm	45mm	150mm	420-150-203
45mm	65mm	150mm	420-150-204
75mm	45mm	150mm	420-150-205
45mm	75mm	150mm	420-150-206

Flexible Arm complete with holding rod	251-010-000
Nasal Specula Clamp for Flexible Arm	251-010-400



Flexible Arm complete with holding rod without Rotating Clamp

Flexible Arm

251-010-000

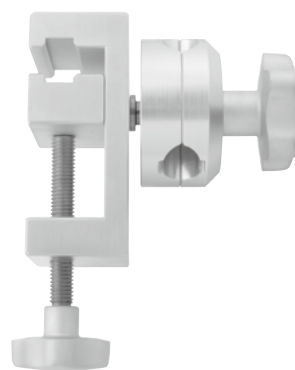

Rotating clamp for flexible tension arm attachable to operating table

Rotating Clamp

251-010-100



Nasal Specula Clamp for Flexible Arm

Nasal Specula Clamp

251-010-400

NASAL INSTRUMENTS

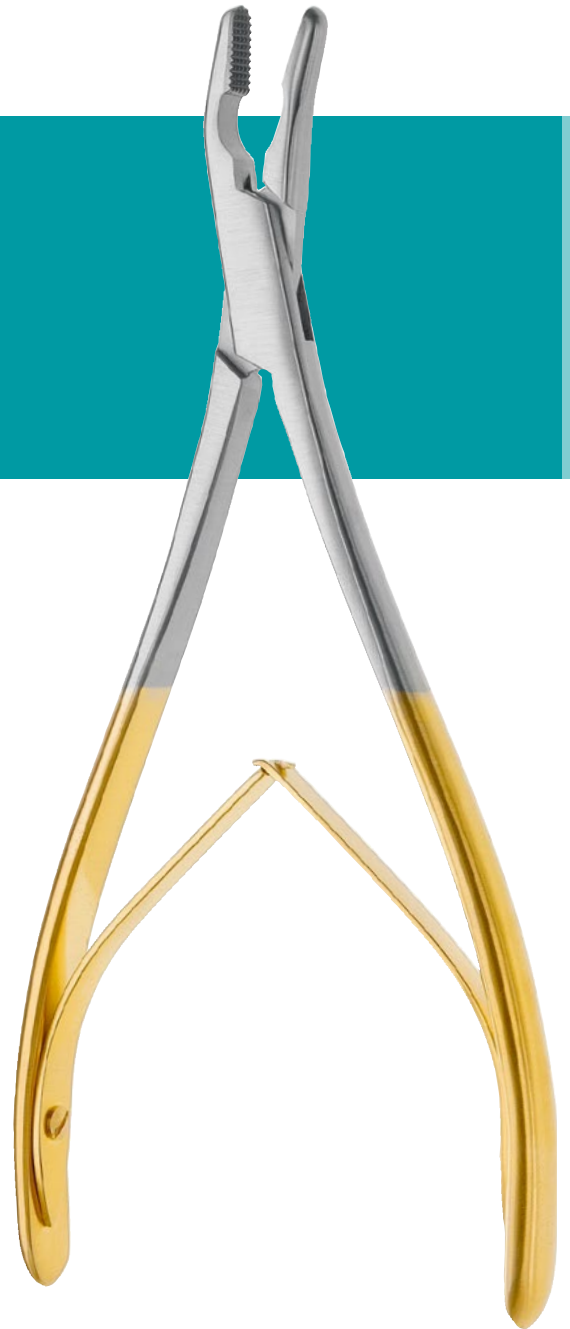



JOSEPH

Septum Raspatory, slightly curved, 170mm, 6^{2/3}"

2mm	420-530-165
-----	-------------

3mm	420-531-165
-----	-------------

4mm	420-532-165
-----	-------------



JOSEPH

Periosteal Elevator, curved, 160mm, 6^{1/4}"

4mm	420-585-160
-----	-------------



OBWEGESER

Periosteal Elevator, curved, 175mm, 6^{5/8}"

6mm	431-630-006
-----	-------------

7mm	431-630-007
-----	-------------

9mm	431-630-009
-----	-------------

11mm	431-630-011
------	-------------



WARD

Periosteal Elevator, curved rand blade, 170mm, 6^{3/4}"

5.5mm	420-553-170
-------	-------------

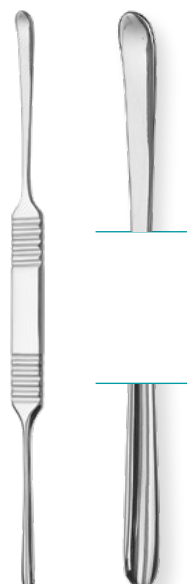

READ

Elevator, double-ended, blunt

215mm, 8 ^{1/2} "	420-481-215
---------------------------	-------------

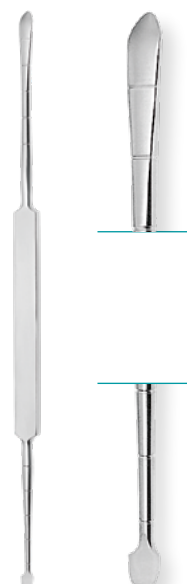

COTTLE

Elevator, double-ended, graduated, sharp/blunt

210mm, 8 ^{1/4} "	420-550-230
---------------------------	-------------



MASING

Septum Elevator, double-ended, graduated, sharp/blunt

200mm, 8"

420-551-200



CARTER

Septum Elevator, double-ended

210mm, 8¹/₄"

420-551-210



OBWEGESER-FREER

Septum Elevator

200mm, 8"

420-532-200



GOLDMANN

Septum elevator, round, for straightening the nose

200mm, 8"

420-189-210



BOIES

Elevator for Septum Repositioning

170mm, 6³/₄"

420-557-170



BOIES

Nasal Fracture Elevator, 9mm

195mm, 7³/₄"

420-555-195

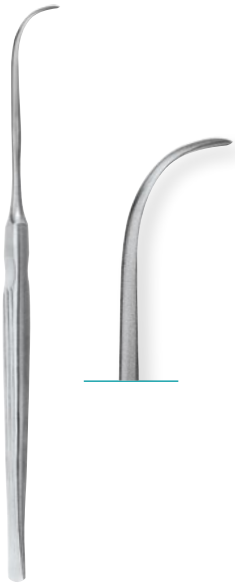

LAMONT

Raspatory, strongly curved, sharp, 170mm, 6²/₃"

3mm	430-531-170
6mm	430-532-170



HOWARTH

Elevator, double-ended, sharp/blunt

215mm, 8 ¹ / ₂ "	420-552-215
--	-------------



JOSEPH

Nasal Saw, 170mm, 6³/₄"

Straight	230-202-000
Bayonet, curved right	230-202-001
Bayonet, curved left	230-202-002



JOSEPH

Nasal Saw, 170mm, 6³/₄"

Right-angled	230-210-170
Left-angled	230-211-170

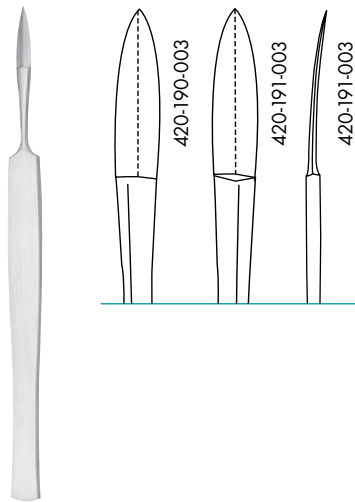

JOSEPH

Nasal Knife, double-edge, sharp, 150mm, 6"

Straight	420-190-003
Curved	420-191-003

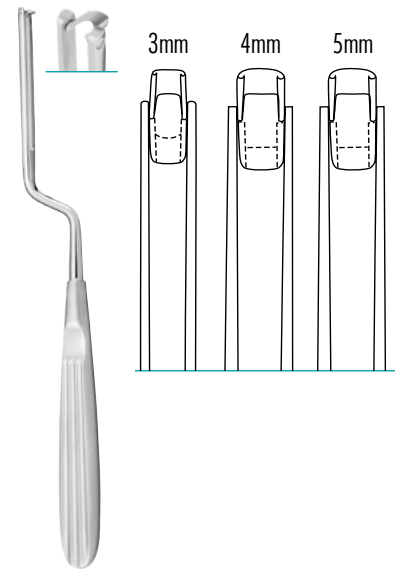

BALLENGER

Swivel Knife, bayonet shaped, 210mm, 8¹/₄"

3mm	420-392-003
4mm	420-392-004
5mm	420-392-005



COTTLE-WALSHAM

Septum Straightening Forceps, aseptic lock, 230mm, 9"

Straight	420-450-230
Left	420-451-230
Right	420-452-230



ASH

Septum Straightening Forceps, 8³/₄"

220mm, 8 ³ / ₄ "	420-455-230
--	-------------



GUNTER

TC Lower Lateral Morselizer

180mm, 7"	420-220-212
-----------	-------------

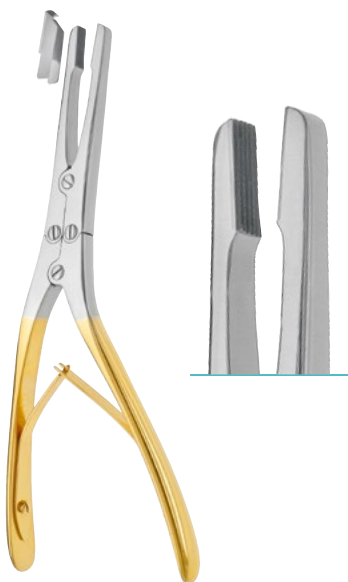

GORNEY

Septal Morselizer, double action, angled, incl. guard

200mm, 8"	420-220-220
-----------	-------------

Guard, only

1 piece	420-221-200
---------	-------------

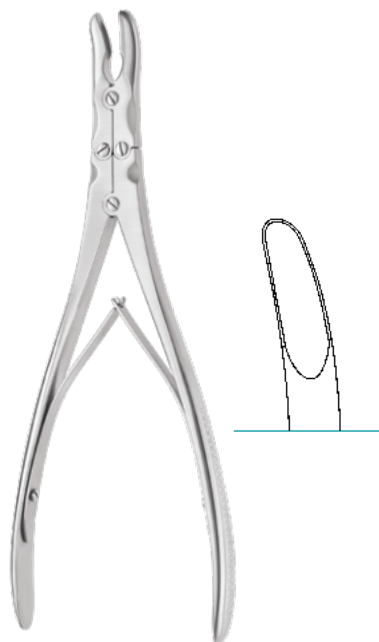

RÖTTGEN-RUSKIN

Bone Rongeur, curved, 5mm, double action

240mm, 9 ¹ / ₂ "	210-792-230
--	-------------



BEYER

Bone Rongeur, curved, double action, 180mm, 7"

4mm	210-790-180
-----	-------------

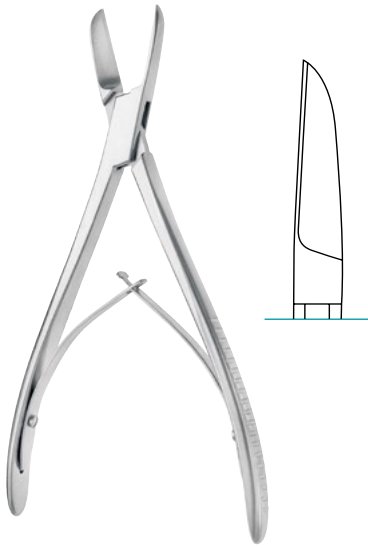

COTTLE-KAZANJIAN
Bone Cutting Forceps, for removal of nasal hump

180mm, 7"

210-845-185

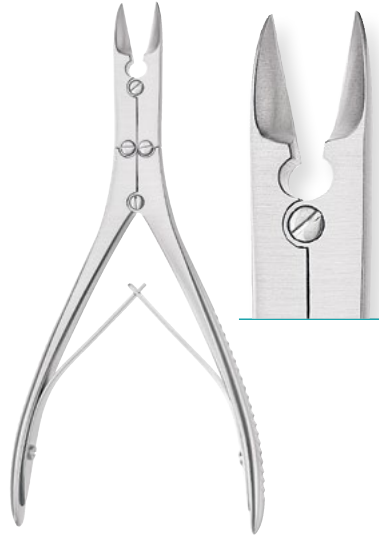

RUSKIN-LISTON
Bone Cutting Forceps, straight

170mm, 6²/₃"

210-844-170



JANSEN-MIDDLETON
Nasal Forceps, through cutting, 4x14mm, 8¹/₄"

210mm, 8¹/₄"

252-031-190



JANSEN-MIDDLETON
Nasal Forceps, 4x11mm, Spoon Jaw

170mm, 6³/₄"

252-032-190



LANGENBECK
Bone Holding Forceps

210mm, 8¹/₂"

210-722-210



DINGMANN
Bone Holding Forceps

190mm, 7¹/₄"

210-626-190



COTTLE
Bone Crusher, complete with clamp

28mm 420-365-000

For preparation of bone graft material.



RZ
Cartilage Crusher

60 x 30mm 420-364-000



Plastic Plate, autoclavable, 85x55mm, 3 x 2"

85x55mm, 3x2" 420-367-000

For preparation of bone grafts.



TOLSDORF
Bone Crusher

40mm, 7" 420-366-000

Inner Diameter

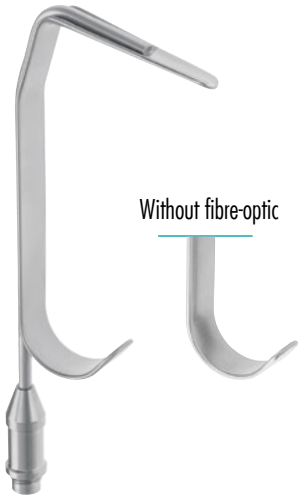

Without fibre-optic

MALINIAC
Nasal Retractor, 9x45mm, 100mm, 4"

Without fibre-optic 420-652-100

With fibre-optic (light carrier) 420-752-100



CONVERSE
Nasal Retractor, 11x44mm

110mm, 4¹/₃" 420-235-110



CONVERSE
Nasal Retractor, fibre-optic light carrier, 11x44mm

110mm, 4¹/₃" 420-236-110



CONVERSE
Nasal Retractor, 90mm, 3¹/₂"

10x20mm 420-237-095

12x30mm 420-238-095

12x40mm 420-239-090

12x50mm 420-239-095



CONVERSE
Nasal Retractor, fibre-optic light carrier, 90mm, 3¹/₂"

10x20mm 420-237-195

12x30mm 420-238-195

12x40mm 420-239-190

12x50mm 420-239-195



DEVINE-MILLARD-AUFRICHT
Nasal Retractor, fibre-optic light carrier, 10x45mm

180mm, 7" 420-257-160

For use with fibre-optic cables (see page 248).



DEVINE-MILLARD-AUFRICHT

Nasal Retractor, 10x45mm

180mm, 7"

420-057-160



AUFRICHT

Nasal Retractor, 10x45mm

160mm, 6¹/₄"

420-250-160



AUFRICHT

Nasal Retractor, fibre-optic light carrier, 120°, 10x45mm

180mm, 7"

420-255-160

DERMATOLOGY INSTRUMENTS



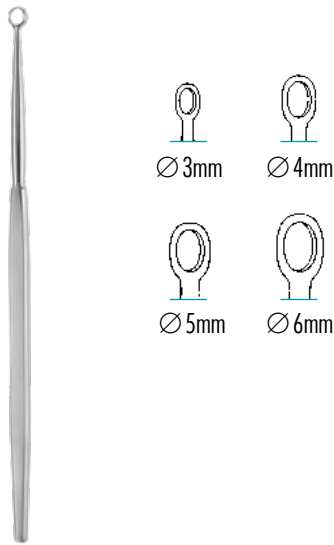

FOX

Lupus curette, round, 140mm, 5¹/₂"

Ø 3mm	230-151-140
Ø 4mm	230-152-140
Ø 5mm	230-153-140
Ø 6mm	230-154-140

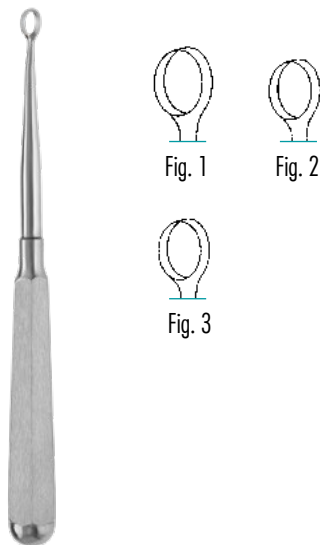

PIFFARD

Lupus curette, 140mm, 5¹/₂"

Fig. 1	230-155-001
Fig. 2	230-155-002
Fig. 3	230-155-003

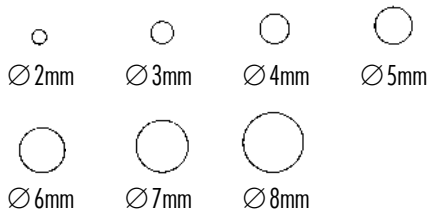

KEYES

Dermal punch, 120mm, 4³/₄"

Ø 2mm	230-160-002	Ø 6mm	230-160-006
Ø 3mm	230-160-003	Ø 7mm	230-160-007
Ø 4mm	230-160-004	Ø 8mm	230-160-008
Ø 5mm	230-160-005		

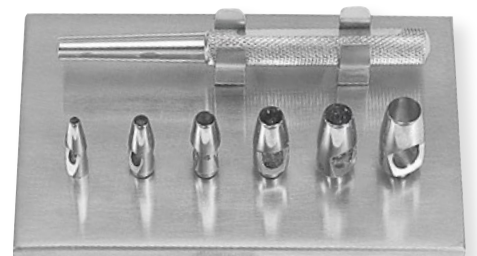
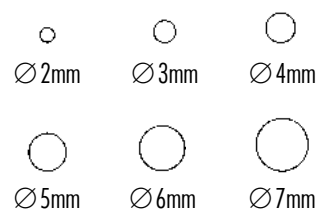

KEYES

Dermal punch set, 1 handle,

Full set	230-160-000
----------	-------------



UNNA
Comedo Extractor, double-ended, oval cup

140mm, 5³/₄"

230-230-140



UNNA
Comedo Extractor, double-ended, round cup

140mm, 5³/₄"

230-232-140



SAALFELD
Comedo Extractor, double-ended

100mm, 4"

230-239-100



SAALFELD
Comedo Extractor, double-ended

140mm, 5³/₄"

230-236-140

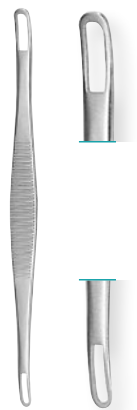

SCHAMBERG
Comedo Extractor, double-ended

100mm, 4"

230-238-100

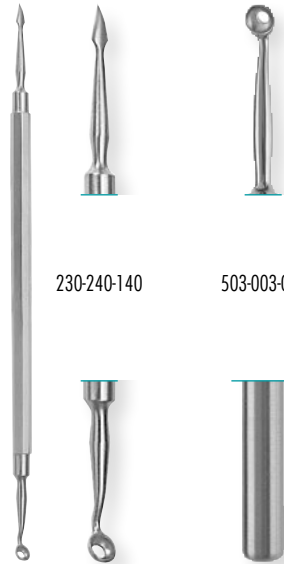

WALTON
Comedone Extractor, double-ended

140mm, 5³/₄"

230-240-140

160mm, 6¹/₄"
(single ended)

503-003-000

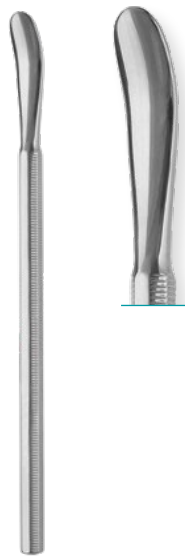

FROST
Elevator

130mm, 5"

503-011-000



FROST
Spatula Packer, double-ended

135mm, 5¹/₃"

503-013-000



Scalpel Handle, 130mm, 5"

No. 3	110-110-003
-------	-------------

No. 4	110-140-004
-------	-------------



BARRON
Scalpel Handle

130mm, 5 ¹ / ₈ "	110-140-000
--	-------------



CORWIN
Scalpel Handle

150mm, 6"	110-148-000
-----------	-------------



Nail Nipper

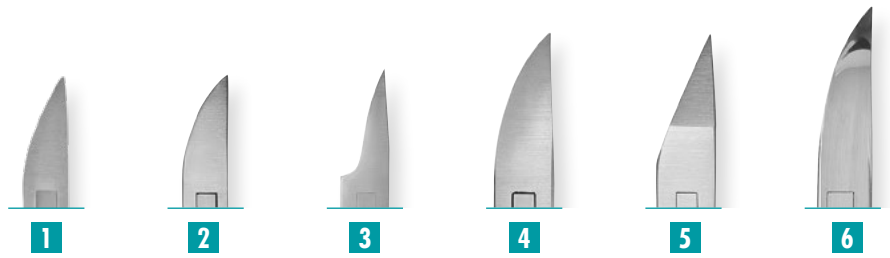

1	100mm, 4"	510-224-140	Straight jaws, double spring
2	110mm, 4 1/2"	510-225-140	Straight jaws, double spring
3	110mm, 4 1/2"	510-225-142	Delicate straight jaws, double spring
4	130mm, 5"	510-226-140	Straight jaws, double spring
5	130mm, 5"	510-226-142	Straight jaws, extra narrow, double spring
6	150mm, 6"	510-227-140	Straight jaws, double spring



Nail nipper, concave jaws

115mm, 4 1/2" **510-205-115**



Nail nipper

130mm, 5" **510-347-130**



Nail nipper concave, spring handle, with lock

150mm, 6" **510-332-150**



Nail Nipper, double spring, 140mm, 5 1/2"

- | | |
|---|-------------|
| 1 | 510-210-140 |
| 2 | 510-215-140 |



Nail Nipper, angled concave jaws, double spring

- | | |
|---------------|-------------|
| 140mm, 5 1/2" | 510-215-140 |
|---------------|-------------|



Mycotic Nail Nipper, straight, heavy duty jaws, double action

- | | |
|---------------|-------------|
| 160mm, 6 1/4" | 510-337-160 |
|---------------|-------------|



Mycotic Nail Nipper, concave, heavy duty jaws, double action

- | | |
|-----------|-------------|
| 150mm, 6" | 510-338-150 |
|-----------|-------------|

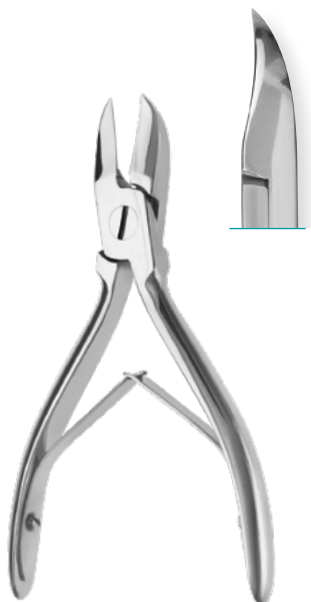

Nail Nipper, concave, single spring

- | | |
|---------------|-------------|
| 115mm, 4 1/2" | 510-200-115 |
|---------------|-------------|



Cuticle and tissue nipper, convex jaws

110mm, 4 1/2" 510-250-110

130mm, 5" 510-251-130

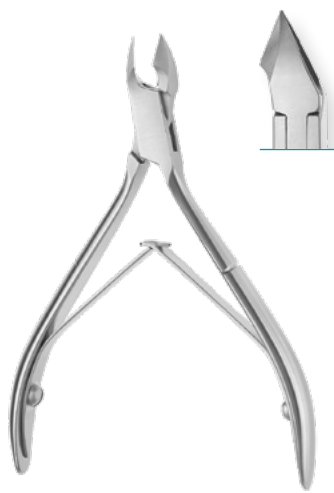

Cuticle and tissue nipper, convex jaws

100mm, 4" 510-245-100



Cuticle and tissue nipper, straight jaws, ring handle

100mm, 4" 510-220-100



RADOLF

Nail extraction forceps, narrow jaws

140mm, 5 1/2" 510-463-140



Nail extraction forceps

135mm, 5 1/3" 510-462-130

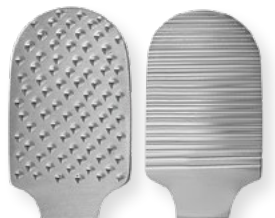

Nail extraction forceps, duck shaped jaws

140mm, 5 1/2" 510-464-140



Nail splitting forceps

135mm, 5³/₈"

510-334-140



Finger ring saw, with replaceable circular blade

170mm, 6²/₃"

210-975-170



Nail Scissors, curved

90mm, 3¹/₂"

510-425-090

Spare circular blade

1 piece

210-976-000

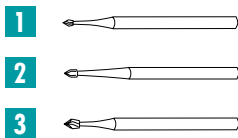

Finger drill only, 1 piece

1 510-460-001

2 510-460-002

3 510-460-003

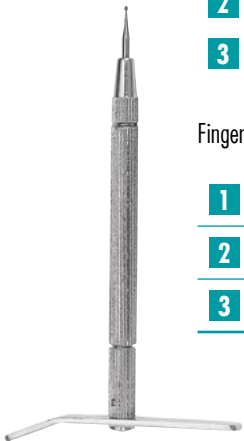

Finger nail drill complete with 3 drill points

170mm, 6²/₃"

510-460-000

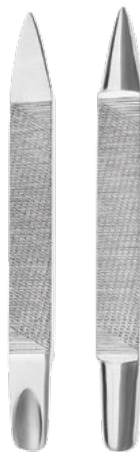

Nail rasp

100mm, 4"

510-050-100

120mm, 4³/₄"

510-050-120



FREER
Mucosa Knife

150mm, 6"

420-195-150



JOSEPH
Button-end Knife, straight

150mm, 5¹/₂"

420-205-160



DINGMAN
Otopraders, set of left and right pattern

160mm, 6¹/₄"

410-033-100

For cutting inner ear cartilage during otoplasty.



STENSTRØM
Ear Scraper, 160mm, 6¹/₄"

Curved left

410-033-130

Curved right

410-033-131



STENSTRØM
Ear Rasp, 160mm, 6¹/₄"

Curved left

410-033-132

Curved right

410-033-133



GOULIAN
Hand Dermatome, 3 templates (0.2/0.25/0.3mm)

190mm, 7¹/₂" 110-096-180

Spare blades, non-sterile

5 pieces 110-096-185



BRAITHWAITE (MODIF. HUMBY)
Hand Dermatome, complete, 305mm, 12"

Left handed 110-097-305

Right handed 110-098-305

Spare blades, non-sterile

10 pieces 110-098-399



SCHINK
Dermatome, exchangeable blade, 2 straightening blades

305mm, 12" 110-090-000

Spare blade

1 piece 110-090-001



SILVER
Skin Graft Knife

190mm, 7¹/₂" 110-096-019

Spare blade

1 piece 110-096-119

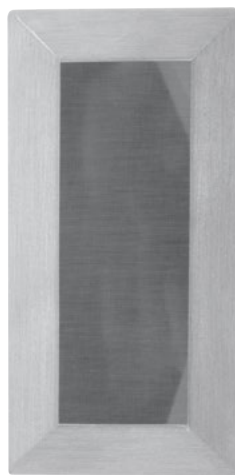

Skin Graft Board
bevelled edge

200x100mm 110-090-150



GABBARO
Skin Graft Measure

110-090-100



Diamond Knife, titanium handle, blade #11

260-800-011



Diamond Knife, titanium handle, blade #15

260-800-015

CLEFT PALATE INSTRUMENTS





CRONIN
Cleft Palate Elevator, 180mm, 7"

Large	430-100-600
Medium	430-100-601
Small	430-100-602



BLAIR
Cleft Palate Elevator, right-angled, blunt

180mm, 7"	430-105-002
-----------	-------------



BLAIR
Cleft Palate Elevator, flat, blunt

200mm, 8"	430-105-003
-----------	-------------



BLAIR
Cleft Palate Elevator, L-Shaped, blunt, rounded

180mm, 7"	430-105-001
-----------	-------------

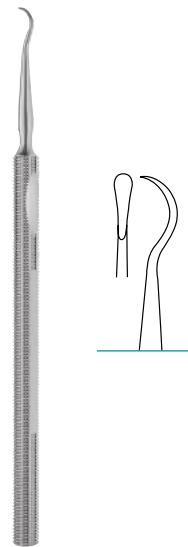

JABOMA
Cleft Palate Periosteal Elevator

170mm, 6 ³ / ₄ "	431-200-100
--	-------------



CRONIN
Cleft Palate Knife, 180mm, 7"

Triangular	430-100-603
Rectangular	430-100-604

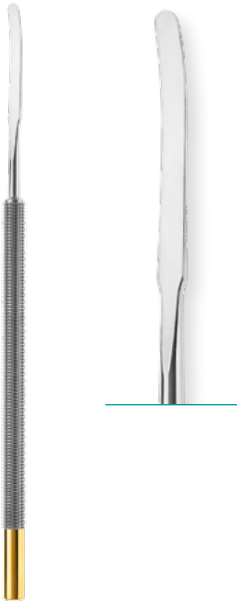

SALYER
Cleft Palate Elevator, 180mm, 7"

Slightly curved	431-200-021
Curved	431-200-023

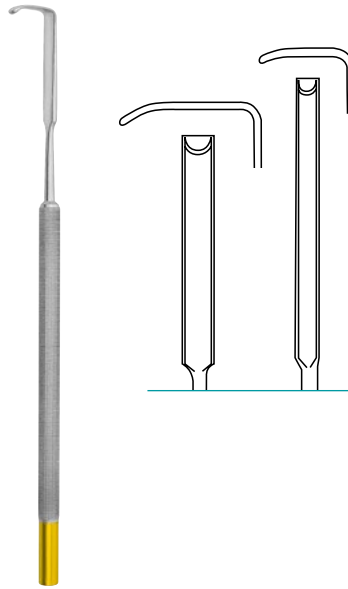

SALYER
Cleft Palate Hooklet, 180mm, 7"

Short blade	431-200-001
Long blade	431-200-003

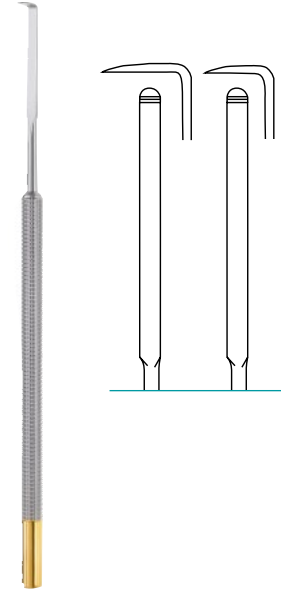

SALYER
Cleft Palate Dissector, 180mm, 7"

Short blade	431-200-011
Long blade	431-200-013

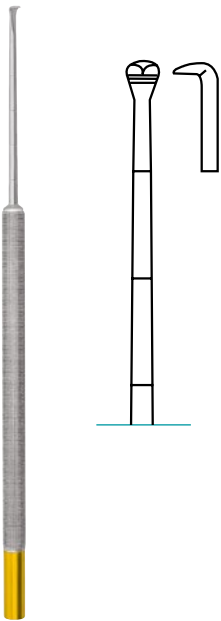

SALYER
Cleft Palate Elevator, triangular blade, 180mm, 7"

Triangular blade	431-200-027
------------------	-------------



Cleft Palate Raspatory, 140mm, 5¹/₂"

Curv. upwards	420-580-145
Curv. downwards	420-583-145



Cleft Palate Raspatory, 140mm, 5¹/₂"

Curv. upwards, right	420-581-140
Curv. upwards, left	420-582-140



Logan Bow, with teeth

28mm / 1 ¹ / ₈ " wide	420-985-013
32mm / 1 ¹ / ₄ " wide	420-985-014
35mm / 1 ¹ / ₃ " wide	420-985-015

SHAPERS

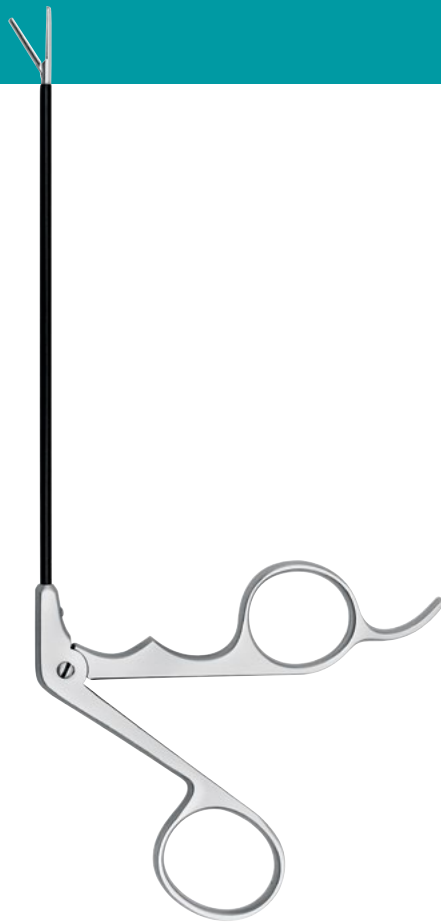



SHAPER Sheath with one rotating stopcock, with angled spatula tip for the best view during tissue dissection

Ø 4 mm 260-501-180

Ø 5 mm 260-501-185



SHAPER Sheath for plastic telescopes with one rotating stopcock, with large angled up spatula tip for the best view during tissue dissection

Ø 4 mm 260-502-180

Ø 5 mm 260-502-185



SHAPER Sheath for plastic Endoscopy, with one rotating stopcock, with a flat spatula tip

Ø 4 mm 251-140-175

Ø 5 mm 251-150-175



SHAPER Sheath for plastic telescopes, with two rotating stopcocks, with a flat spatula tip

Ø 4 mm 251-340-175

Ø 5 mm 251-345-175



SHAPER Telescope for Plastic Endoscopy, 30°, Wide Angle, autoclavable, for use with all SHAPER Sheaths

Ø 4 mm 260-104-030

SHAPER Dissectors are designed to fit facial contours. The large number of different dissectors enables the application under any anatomical conditions.

The well balanced instruments with their special handle design provide a secure grip and ensure precise and untiring working during long surgeries.

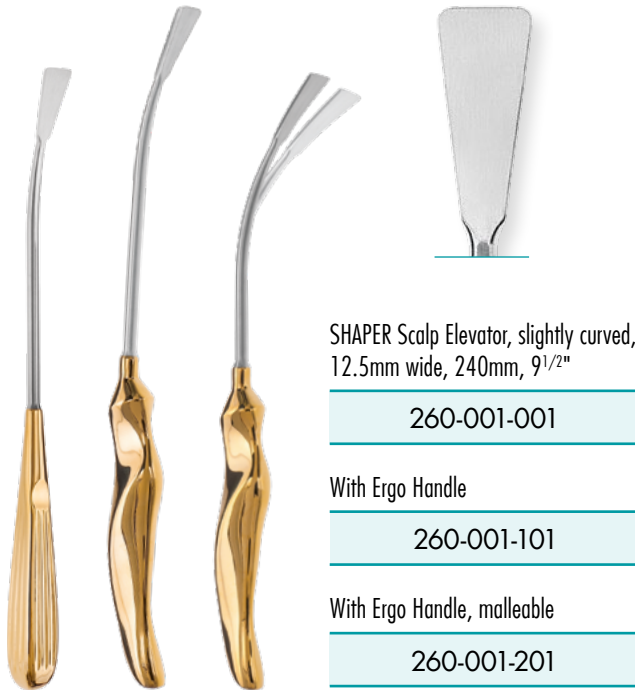



SHAPER Scalp Elevator, straight,
7.0mm wide, 240mm, 9¹/₂"

260-002-003

With Ergo Handle

260-002-103

With Ergo Handle, malleable

260-002-203



SHAPER Frontotemporal Dissector, curved,
6.5mm wide, 240mm, 9¹/₂"

260-020-001

With Ergo Handle

260-020-101

With Ergo Handle, malleable

260-020-201



SHAPER Frontoglabellar Dissector,
s-shaped, 265mm, 10¹/₂"

260-023-000

With Ergo Handle

260-023-100

With Ergo Handle, malleable

260-023-200



SHAPER Arcus Marginalis Dissector,
s-shaped, 240mm, 9¹/₂"

260-024-000

With Ergo Handle

260-024-100

With Ergo Handle, malleable

260-024-200





SHAPER Frontotemporal Dissector, straight, 10mm wide, 225mm, 8^{3/4}"

260-020-000

With Ergo Handle

260-020-100



SHAPER Periosteal Dissector, s-shaped, 5mm wide, 240mm, 9^{1/2}"

With Ergo Handle

260-025-100



SHAPER Nerve Dissector, slightly curved, 240mm, 9^{1/2}"

260-003-001

With Ergo Handle

260-003-101

With Ergo Handle, malleable

260-003-201



SHAPER Orbital Rim Dissector, half curved, 240mm, 9^{1/2}"

260-004-001

With Ergo Handle

260-004-101

With Ergo Handle, malleable

260-004-201





SHAPER Temporal Dissector, straight,
235mm, 9 1/4"

260-022-000

With Ergo Handle

260-022-100

With Ergo Handle, malleable

260-022-200



SHAPER Periosteal Dissector, curved,
250mm, 10"

260-021-000

With Ergo Handle

260-021-100

With Ergo Handle, malleable

260-021-200



SHAPER-Mini, Endoforehead Dissector,
full curved, with Ergo handle

285mm, 11 1/4"

260-202-105



RAMIREZ
Flap Dissector, straight, Ergo handle

250mm, 10"

260-026-100



RAMIREZ
Endoforehead Corrugator, Procerus Dissector, 5mm

195mm, 4²/₃"

260-008-005



RAMIREZ
Endoforehead Corrugator, Procerus Dissector, 7mm

195mm, 4²/₃"

260-008-007



Periost Elevator,
7mm wide, curved

235mm, 9¹/₄"

260-002-002



SHAPER Nerve Hook,
240mm, 9¹/₂"

Curved right

260-003-002

Curved left

260-003-003



SHAPER Nerve Hook,
malleable, with graduation

235mm, 9¹/₄"

260-014-230



SHAPER Nerve Protector,
curved right

170mm, 6³/₄"

260-008-003



SHAPER Nerve Protector,
curved left

170mm, 6³/₄"

260-008-002



Suction Elevator, medium curved,
8mm wide, round edge

260mm, 10¹/₄"

260-002-015



Suction Elevator, slightly curved,
8mm wide, round edge

260mm, 10¹/₃"

260-002-005



Scalpel Handle for blades Fig. 10-15,
angled downwards

230mm, 9"

260-006-001

SHAPER Grasping Forceps, long serrated jaws, insulated shaft, Ø 2.7mm, 5" working length

Straight	260-204-100
Right curved	260-204-200
Left curved	260-204-500

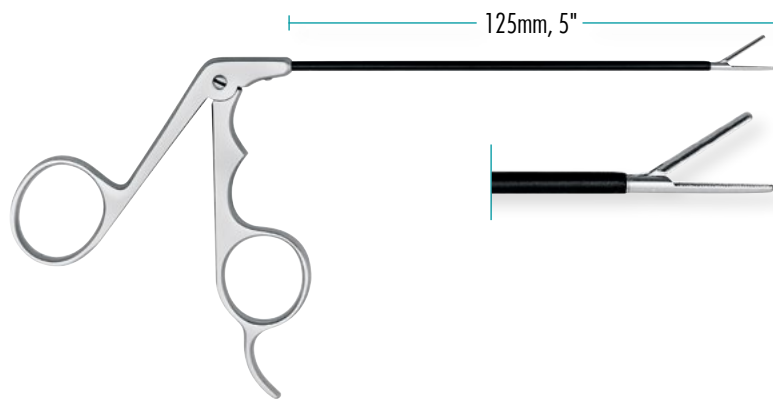

SHAPER Grasping Forceps, short strong jaws, insulated shaft, Ø 2.7mm, 5" working length

Straight	260-204-600
Right curved	260-204-400
Left curved	260-204-300

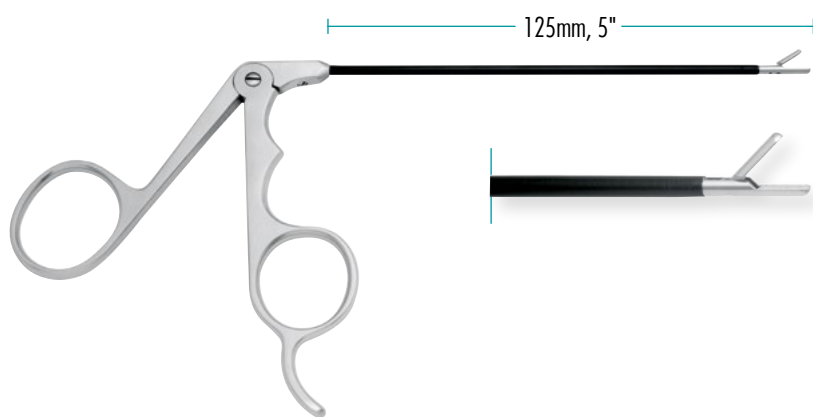

SHAPER Grasping Forceps, short jaws, aggressive teeth, insulated shaft, Ø 2.7 mm, 5" working length

Straight	260-204-627
Right curved	260-204-427
Left curved	260-204-327

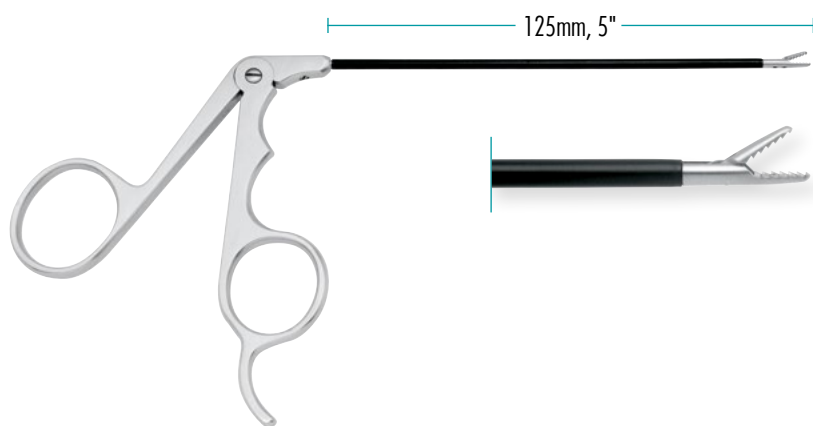

SHAPER Hook Scissors, insulated shaft, Ø 3.4mm, 5" working length

Straight	260-203-600
Right curved	260-203-700
Left curved	260-203-800

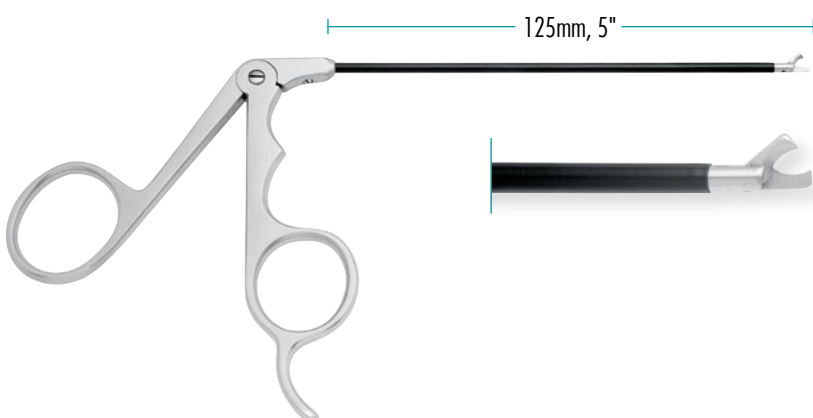

ENDOSCOPIC INSTRUMENTS





PEEK Polymer Laparoscopic Handle, for modular instrument inserts, gold plated HF-connection, rotatable

Without ratchet

300-750-101



PEEK Polymer Laparoscopic Handle, for modular instrument inserts, gold plated HF-connection, rotatable

With ratchet

300-750-103



PEEK Polymer Laparoscopic Handle, for modular instrument inserts, gold plated HF-connection, rotatable

With hook up ratchet

300-750-105



PEEK Polymer Laparoscopic Handle, for modular instrument inserts, gold plated HF-connection, rotatable

With swing ratchet

300-750-106

For use with a monopolar cable (see page 76).



Micro Maryland Dissecting Forceps,
curved shaft, rotating, insulated, insert

260-610-100



Micro Grasping Forceps, curved shaft,
rotating, insulated, insert

260-604-100



Micro Grasping Forceps with alligator jaws,
curved shaft, rotating, insulated, insert

260-608-100



Micro Hook Scissors, curved shaft,
rotating, insulated, insert, single action

260-600-100



Micro Scissors, curved shaft, curved blades,
rotating, insulated, insert, double action

260-614-100



Micro Scissors, curved shaft, rotating,
insulated, straight blade, insert, double action

260-615-100

For use with a monopolar cable (see page 76).



Spatula Electrode, straight, with suction and trumpet valve

WL 270mm, 10¹/₃"

260-712-000



Spatula Electrode, curved, with suction and trumpet valve

WL 270mm, 10¹/₃"

260-702-000

For use with a monopolar cable (see page 76).



J-Hook Electrode, straight, with suction and trumpet valve

WL 270mm, 10¹/₃"

260-710-000



J-Hook Electrode, curved, with suction and trumpet valve

WL 270mm, 10¹/₃"

260-700-000

For use with a monopolar cable (see page 76).



Plastic Surgery Endoscope, 30°, Ø10mm

WL 175mm, 6^{3/4}" **260-110-030**

Plastic Surgery Endoscope, 0°, Ø10mm

WL 175mm, 6^{3/4}" **260-110-000**



Plastic Surgery Endoscope, 30°, wide angle,
175mm, 6^{3/4}", autoclavable

Ø 4mm **260-104-030**

RETRACTORS & DISSECTORS





Round and smooth blade

FERREIRA STYLE
Breast Retractor,
round and smooth blade

Blade size	Order number	Blade size	Order number
70x16mm	260-070-616	130x16mm	260-130-616
70x25mm	260-070-625	150x16mm	260-150-616
80x16mm	260-080-616	150x25mm	260-150-625
80x25mm	260-080-625	150x30mm	260-150-630
90x16mm	260-090-616	150x36mm	260-150-636
90x24mm	260-090-624	180x16mm	260-180-616
90x27mm	260-090-627	180x25mm	260-180-625
90x30mm	260-090-630	180x30mm	260-180-630
100x25mm	260-100-625	190x25mm	260-190-625
110x25mm	260-110-625	190x36mm	260-190-636
120x25mm	260-120-625	220x25mm	260-220-625



Round and smooth blade



Fibre-optic

FERREIRA STYLE
Breast Retractor, round and
smooth blade, with fibre-optic

Blade size	Order number	Blade size	Order number
70x16mm	260-070-016	130x16mm	260-230-019
70x25mm	260-070-025	150x16mm	260-150-016
80x16mm	260-080-016	150x25mm	260-150-025
80x25mm	260-080-025	150x30mm	260-150-030
90x16mm	260-090-016	150x36mm	260-150-036
90x24mm	260-090-024	180x16mm	260-180-016
90x27mm	260-090-027	180x25mm	260-180-025
90x30mm	260-090-030	180x30mm	260-180-030
100x25mm	260-100-025	190x25mm	260-190-025
110x25mm	260-111-025	190x36mm	260-190-036
120x25mm	260-120-025	220x25mm	260-220-025



Round and smooth blade



Fibre-optic



Suction

FERREIRA STYLE
Breast Retractor, round and smooth blade,
with fibre-optic and suction

Blade size	Order number
70x16mm	260-070-116
70x25mm	260-070-125
80x16mm	260-080-116
80x25mm	260-080-125
90x16mm	260-090-116
90x24mm	260-090-124
90x27mm	260-090-127
90x30mm	260-090-130
100x25mm	260-100-125
110x25mm	260-110-125
120x25mm	260-120-125

Blade size	Order number
130x16mm	260-130-116
150x16mm	260-150-116
150x25mm	260-150-125
150x30mm	260-150-130
150x36mm	260-150-136
180x16mm	260-180-116
180x25mm	260-180-125
180x30mm	260-180-130
190x25mm	260-190-125
190x36mm	260-190-136
220x25mm	260-220-125



FERREIRA STYLE
Breast Retractor, silicone handle, round and smooth blade, with fibre-optic



Silicone handle



Round and smooth blade

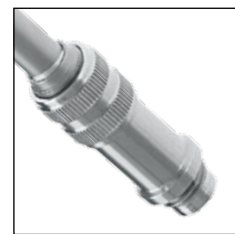

Fibre-optic

Blade size	Order number
70x16mm	260-070-916
70x25mm	260-070-925
80x16mm	260-080-916
80x25mm	260-080-925
90x16mm	260-090-916
90x24mm	260-090-924
90x27mm	260-090-927
90x30mm	260-090-930
100x25mm	260-100-925
110x25mm	260-110-925
120x25mm	260-120-925

Blade size	Order number
130x16mm	260-130-916
150x16mm	260-150-916
150x25mm	260-150-925
150x30mm	260-150-930
150x36mm	260-150-936
180x16mm	260-180-916
180x25mm	260-180-925
180x30mm	260-180-930
190x25mm	260-190-925
190x36mm	260-190-936
220x25mm	260-220-925



Square toothed blade

TEBBET STYLE
Breast Retractor,
square and toothed blade

Blade size	Order number	Blade size	Order number
70x16mm	260-070-716	130x16mm	260-130-716
70x25mm	260-070-725	150x16mm	260-150-716
80x16mm	260-080-716	150x25mm	260-150-725
80x25mm	260-080-725	150x30mm	260-150-730
90x16mm	260-090-716	150x36mm	260-150-736
90x24mm	260-090-724	180x16mm	260-180-716
90x27mm	260-090-727	180x25mm	260-180-725
90x30mm	260-090-730	180x30mm	260-180-730
100x25mm	260-100-725	190x25mm	260-190-725
110x25mm	260-110-725	190x36mm	260-190-736
120x25mm	260-120-725	220x25mm	260-220-725



Square toothed blade



Fibre-optic

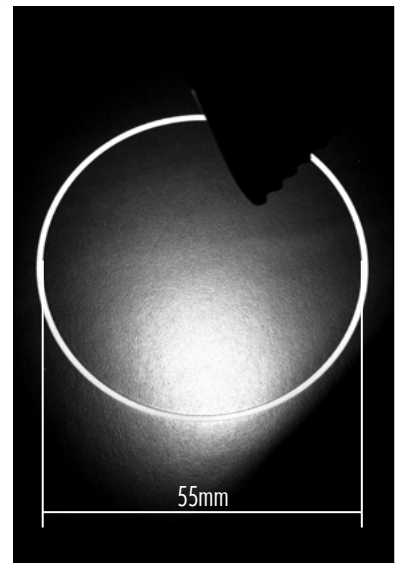

Tebbet Style Breast Retractor light intensity example

TEBBET STYLE
Breast Retractor, square and toothed blade, with fibre-optic

Blade size	Order number
70x16mm	260-070-216
70x25mm	260-070-225
80x16mm	260-080-216
80x25mm	260-080-225
90x16mm	260-090-216
90x24mm	260-090-224
90x27mm	260-090-227
90x30mm	260-090-230
100x25mm	260-100-225
110x25mm	260-110-225
120x25mm	260-120-225

Blade size	Order number
130x16mm	260-134-130
150x16mm	260-150-216
150x25mm	260-150-225
150x30mm	260-150-230
150x36mm	260-150-236
180x16mm	260-180-216
180x25mm	260-180-225
180x30mm	260-180-230
190x25mm	260-190-225
190x36mm	260-190-236
220x25mm	260-220-225

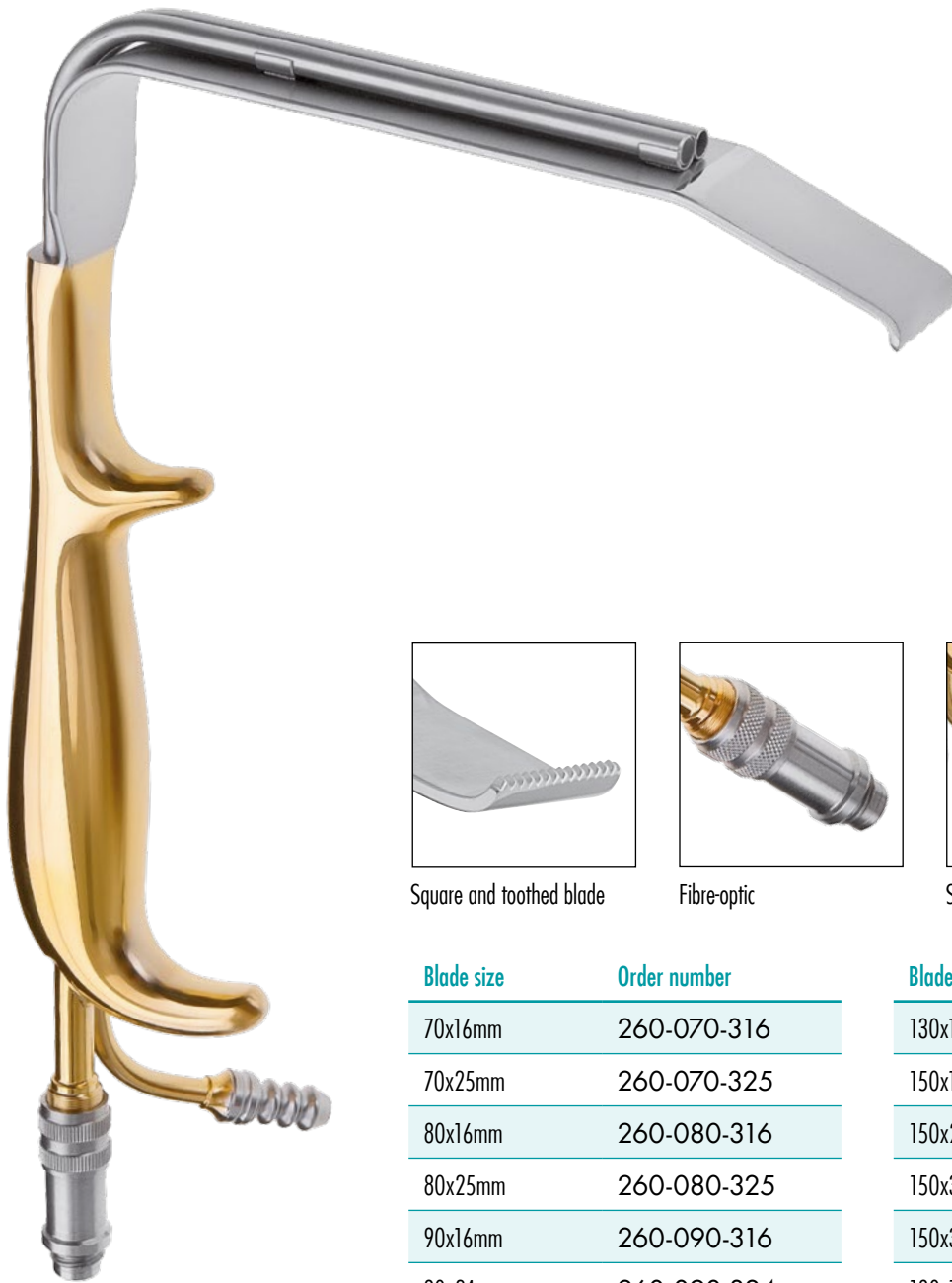

Square and toothed blade



Fibre-optic



Suction

TEBBET STYLE

Breast Retractor, square and toothed blade, with fibre-optic and suction

Blade size	Order number
70x16mm	260-070-316
70x25mm	260-070-325
80x16mm	260-080-316
80x25mm	260-080-325
90x16mm	260-090-316
90x24mm	260-090-324
90x27mm	260-090-327
90x30mm	260-090-330
100x25mm	260-100-325
110x25mm	260-110-325
120x25mm	260-120-325

Blade size	Order number
130x16mm	260-130-316
150x16mm	260-150-316
150x25mm	260-150-325
150x30mm	260-150-330
150x36mm	260-150-336
180x16mm	260-180-316
180x25mm	260-180-325
180x30mm	260-180-330
190x25mm	260-190-325
190x36mm	260-190-336
220x25mm	260-220-325



Square and smooth blade

RZ TEBBET STYLE
Breast Retractor,
square and smooth blade

Blade size	Order number
70x16mm	260-070-816
70x25mm	260-070-825
80x16mm	260-080-816
80x25mm	260-080-825
90x16mm	260-090-816
90x24mm	260-090-824
90x27mm	260-090-827
90x30mm	260-090-830
100x25mm	260-100-825
110x25mm	260-110-825
120x25mm	260-120-825

Blade size	Order number
130x16mm	260-130-816
150x16mm	260-150-816
150x25mm	260-150-825
150x30mm	260-150-830
150x36mm	260-150-836
180x16mm	260-180-816
180x25mm	260-180-825
180x30mm	260-180-830
190x25mm	260-190-825
190x36mm	260-190-836
220x25mm	260-220-825



Square and smooth blade



Fibre-optic

RZ TEBBET STYLE
Breast Retractor, square and
smooth blade, with fibre-optic

Blade size	Order number	Blade size	Order number
70x16mm	260-070-416	130x16mm	260-130-416
70x25mm	260-070-425	150x16mm	260-150-416
80x16mm	260-080-416	150x25mm	260-150-425
80x25mm	260-080-425	150x30mm	260-150-430
90x16mm	260-090-416	150x36mm	260-150-436
90x24mm	260-090-425	180x16mm	260-180-416
90x27mm	260-090-427	180x25mm	260-180-425
90x30mm	260-090-430	180x30mm	260-180-430
100x25mm	260-100-425	190x25mm	260-190-425
110x25mm	260-110-425	190x36mm	260-190-436
120x25mm	260-120-425	220x25mm	260-220-425



Square and smooth blade



Fibre-optic



Suction

RZ TEBBET STYLE

Breast Retractor, square and smooth blade, with fibre-optic and suction

Blade size	Order number
70x16mm	260-070-516
70x25mm	260-070-525
80x16mm	260-080-516
80x25mm	260-080-525
90x16mm	260-090-516
90x24mm	260-090-524
90x27mm	260-090-527
90x30mm	260-090-530
100x25mm	260-100-525
110x25mm	260-110-525
120x25mm	260-120-525

Blade size	Order number
130x16mm	260-130-516
150x16mm	260-150-516
150x25mm	260-150-525
150x30mm	260-150-530
150x36mm	260-150-536
180x16mm	260-180-516
180x25mm	260-180-525
180x30mm	260-180-530
190x25mm	260-190-525
190x36mm	260-190-536
220x25mm	260-220-525

	ROUND & SMOOTH BLADE			SQUARE & TOOTHED BLADE		
	Standard	Fibre-optic	Fibre-optic & suction	Standard	Fibre-optic	Fibre-optic & suction
70x16mm	260-070-616	260-070-016	260-070-116	260-070-716	260-070-216	260-070-316
70x25mm	260-070-625	260-070-025	260-070-125	260-070-725	260-070-225	260-070-325
80x16mm	260-080-616	260-080-016	260-080-116	260-080-716	260-080-216	260-080-316
80x25mm	260-080-625	260-080-025	260-080-125	260-080-725	260-080-225	260-080-325
90x16mm	260-090-616	260-090-016	260-090-116	260-090-716	260-090-216	260-090-316
90x24mm	260-090-624	260-090-024	260-090-124	260-090-724	260-090-224	260-090-324
90x27mm	260-090-627	260-090-027	260-090-127	260-090-727	260-090-227	260-090-327
90x30mm	260-090-630	260-090-030	260-090-130	260-090-730	260-090-230	260-090-330
100x25mm	260-100-625	260-100-025	260-100-125	260-100-725	260-100-225	260-100-325
110x25mm	260-110-625	260-111-025	260-110-125	260-110-725	260-110-225	260-110-325
120x25mm	260-120-625	260-120-025	260-120-125	260-120-725	260-120-225	260-120-325
130x16mm	260-130-616	260-230-019	260-130-116	260-130-716	260-134-130	260-130-316
150x16mm	260-150-616	260-150-016	260-150-116	260-150-716	260-150-216	260-150-316
150x25mm	260-150-625	260-150-025	260-150-125	260-150-725	260-150-225	260-150-325
150x30mm	260-150-630	260-150-030	260-150-130	260-150-730	260-150-230	260-150-330
150x36mm	260-150-636	260-150-036	260-150-136	260-150-736	260-150-236	260-150-336
180x16mm	260-180-616	260-180-016	260-180-116	260-180-716	260-180-216	260-180-316
180x25mm	260-180-625	260-180-025	260-180-125	260-180-725	260-180-225	260-180-325
180x30mm	260-180-630	260-180-030	260-180-130	260-180-730	260-180-230	260-180-330
190x25mm	260-190-625	260-190-025	260-190-125	260-190-725	260-190-225	260-190-325
190x36mm	260-190-636	260-190-036	260-190-136	260-190-736	260-190-236	260-190-336
220x25mm	260-220-625	260-220-025	260-220-125	260-220-725	260-220-225	260-220-325

	SQUARE & SMOOTH BLADE			SILICONE
	Standard	Fibre-optic	Fibre-optic & suction	Fibre-optic
70x16mm	260-070-816	260-070-416	260-070-516	260-070-916
70x25mm	260-070-825	260-070-425	260-070-525	260-070-925
80x16mm	260-080-816	260-080-416	260-080-516	260-080-916
80x25mm	260-080-825	260-080-425	260-080-525	260-080-925
90x16mm	260-090-816	260-090-416	260-090-516	260-090-916
90x24mm	260-090-824	260-090-425	260-090-524	260-090-924
90x27mm	260-090-827	260-090-427	260-090-527	260-090-927
90x30mm	260-090-830	260-090-430	260-090-530	260-090-930
100x25mm	260-100-825	260-100-425	260-100-525	260-100-925
110x25mm	260-110-825	260-110-425	260-110-525	260-110-925
120x25mm	260-120-825	260-120-425	260-120-525	260-120-925
130x16mm	260-130-816	260-130-416	260-130-516	260-130-916
150x16mm	260-150-816	260-150-416	260-150-516	260-150-916
150x25mm	260-150-825	260-150-425	260-150-525	260-150-925
150x30mm	260-150-830	260-150-430	260-150-530	260-150-930
150x36mm	260-150-836	260-150-436	260-150-536	260-150-936
180x16mm	260-180-816	260-180-416	260-180-516	260-180-916
180x25mm	260-180-825	260-180-425	260-180-525	260-180-925
180x30mm	260-180-830	260-180-430	260-180-530	260-180-930
190x25mm	260-190-825	260-190-425	260-190-525	260-190-925
190x36mm	260-190-836	260-190-436	260-190-536	260-190-936
220x25mm	260-220-825	260-220-425	260-220-525	260-220-925



Round and smooth blade
(Ferreira Style)



Square and toothed blade
(Tebbet Style)



Square and smooth blade
(RZ Tebbet Style)

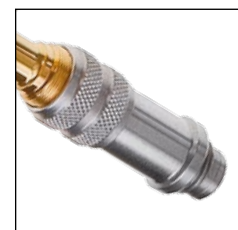

Fibre-optic connection



Suction connection

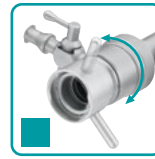

RZ scope connection



Universal scope connection



Smooth blade connection

Breast Optic Retractor, for \varnothing 10mm optic, with stopcock

Blade size	Connection	Scopes	Order number
180x16mm		\varnothing 4mm	260-130-160
180x25mm		\varnothing 4mm	260-130-000
180x25mm		\varnothing 10mm	260-130-015
180x25mm		\varnothing 10mm	260-130-016
180x25mm		\varnothing 5mm	260-130-014



DEAVER

Retractor with Silicone Handle, 35x300mm

With fibre-optic	260-293-300
With suction	260-135-300



ACMI/Storz



R. Wolf



RZ/Gyrus



Universal adaptor for fibre-optic retractors

1 piece	260-990-999
---------	-------------

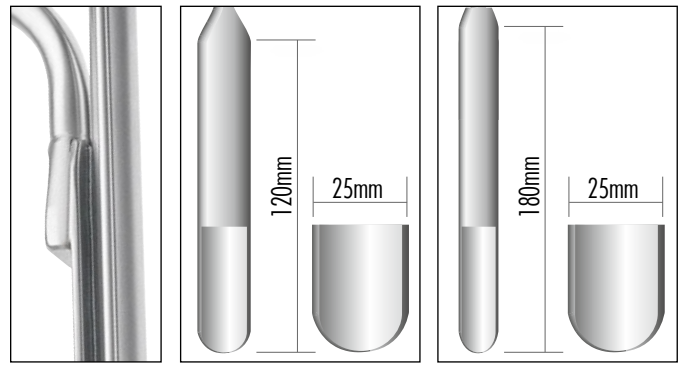

reinforced version

120x25mm blade

180x25mm blade

Mammary Retractor, solid blade, for \varnothing 10mm optic, with universal scope connection

Blade size

Order number

120x25mm

260-145-250

180x25mm

260-137-010

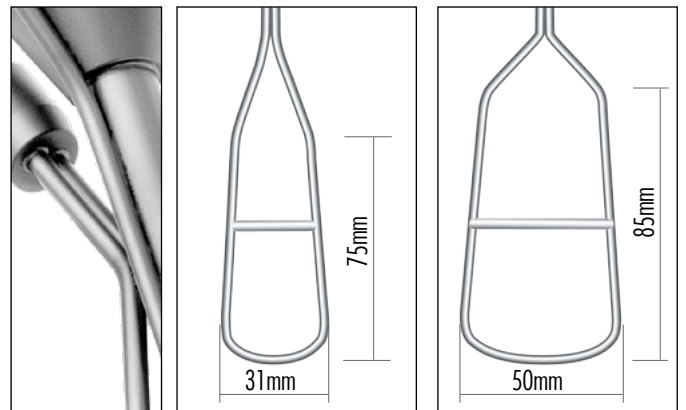

reinforced version

31mm blade

50mm blade

BIGGS

Mammary Retractor, fenestrated 31 mm blade

Blade size

Order number

For 10mm scopes

260-135-000

For 4mm scopes

260-135-004

For 5mm scopes

260-135-005

Fenestrated 50mm blade

Blade size

Order number

For 10mm scopes

260-145-000

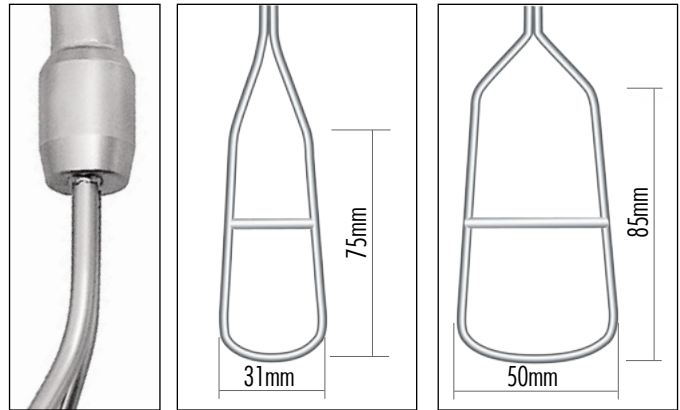

reinforced version

31mm blade

50mm blade

Mammary Retractor, fenestrated blade

Blade size	Order number
31mm	260-037-000
50mm	260-039-000

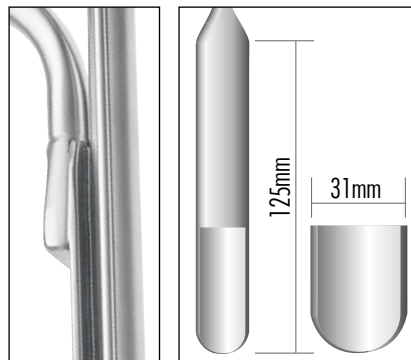

reinforced version

125x31mm blade

Mammary Retractor, fenestrated blade

Blade size	Order number
31mm	260-138-000



Breast and Facial Retractor, fenestrated blade, fine serration, 125mm, 5"

30mm blade	430-297-140
40mm blade	430-297-150



Breast and Facial Retractor, fenestrated blade, fine serration, **insulated**, 125mm, 5"

30mm blade	430-797-140
40mm blade	430-797-150



Breast and Facial Retractor with suction, fine serrations, 125mm, 5"

30mm blade	430-397-140
40mm blade	430-397-150



Breast and Facial Retractor, fenestrated blade, fine serration, fibre-optic, 125mm, 5"

30mm blade	430-497-141
40mm blade	430-497-151



Breast and Facial Retractor, fenestrated blade, fine serration, **insulated**, fibre-optic, 125mm, 5"

30mm blade	430-797-141
40mm blade	430-797-151

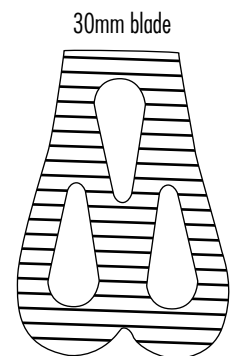

1:1

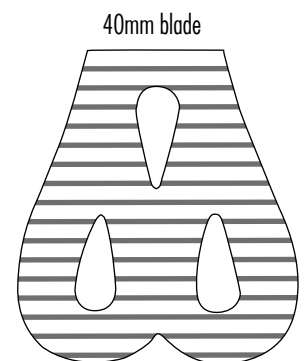

1:1

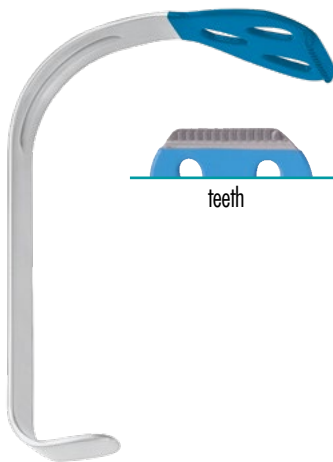

WIEDER
Breast & Facial Retractor, teeth, insulated, 140mm, 5¹/₂"

40mm blade 430-797-155



FERREIRA
Facelift Retractor, 155mm, 6¹/₈"

110x20mm blade 260-030-110



FERREIRA
Facelift Retractor, 110x22mm blade, 100mm, 4"

With fibre-optic 260-130-110
W/o fibre-optic 260-230-110



DEAVER
Retractor, with fibre-optic, 230mm, 9"

110x25mm blade 170-581-230



DEAVER
Retractor, with fibre-optic, 300mm, 12"

25mm blade 170-581-300



HEANEY-SIMON
Abdominal Retractor, with fibre-optic, 280mm, 11"

115x27mm blade 170-457-102



HAJEK
Abdominal Retractor, 180mm, 7"

20mm blade

170-285-165



DEAVER
Grip Retractor, serrated, ergonomic handle

25 x 300mm

171-483-025

38 x 310mm

171-483-138



DEAVER
Retractor, serrated, insulated, 215mm, 8¹/₂"

22mm blade

171-891-215



DEAVER
Retractor, serrated, insulated, 300mm, 12"

25mm blade

171-891-300



DEAVER
Retractor, serrated, 300mm, 12"

38mm blade

171-593-300



DEAVER
Retractor, serrated working end, suction, 300mm, 12"

25mm blade

260-591-300



HEANEY

Retractor, serrated, 270mm, 10^{2/3}"

73x28mm blade	170-459-001
45x25mm blade	170-459-002
82x28mm blade	170-459-003



HEANEY

Retractor, serrated, fibre-optic, 270mm, 10^{2/3}"

73x28mm blade	260-459-001
45x25mm blade	260-459-002
82x28mm blade	260-459-003



CZERNY

Retractor, 38x42mm prongs, 180mm, 7"

36mm blade	170-653-000
------------	-------------



CANNY-RYALL

Retractor, single hook, fenestrated, 200mm, 7^{3/4}"

30mm blade	170-654-030
------------	-------------



MORRIS

Retractor, double-ended, 45x50mm/50x50mm

240mm, 9 ^{1/2} "	170-654-007
---------------------------	-------------



PARKER-LANGENBECK (SET)

Retractor US Army, Fig. 1 & Fig. 2, insulated

220mm, 8 ^{2/3} "	170-687-211
---------------------------	-------------



FREEMAN
Flap Retractor, 205mm, 8"

12mm wide	260-012-205
25mm wide	260-025-205



FREEMAN
Flap Retractor, fibre-optic, 205mm, 8"

12mm blade	260-512-205
25mm blade	260-525-205



LAROE
Undermining Forceps, curved

245mm, 9 ² / ₃ "	260-001-250
--	-------------



LAROE
Undermining Forceps, full curved

300mm, 12"	260-002-300
------------	-------------



LOCKWOOD
Underminer, lift: 30mm

380mm, 15"	260-603-380
450mm, 19"	260-603-450



Coronal Brow Lift Retractor,
7 prongs

180mm, 7"

260-012-199



Coronal Brow Lift Retractor,
7 prongs, reversed

180mm, 7"

260-012-200



Coronal Brow Lift Retractor,
sharp, 6 prongs

230mm, 9"

260-012-202



FREEMAN
Coronal Brow Lift Retractor, 6 prongs

180mm, 7"

260-012-201



YANCOSKIE
Abdominoplasty Retractor, 6 prongs

150mm, 6"

260-013-201



TITLEY
Breast Retractor, with micro tothing

220mm, 8^{2/3}"

260-400-220



SCULPO
Breast Retractor, double-ended, 37x70mm/22x54mm

230mm, 9" 260-400-310

310mm, 12¹/₄" 260-401-310



SCULPO
Breast Spatula, semi-malleable, serrated, 315mm, 12¹/₃"

150x25mm blade 260-400-315

150x38mm blade 260-438-315



SCULPO
Breast Dissector, blunt, curved

340mm, 13¹/₃" 260-009-000

1:2



BYRD
Breast Dissector, straight, 12mm

230mm, 9" 260-012-230

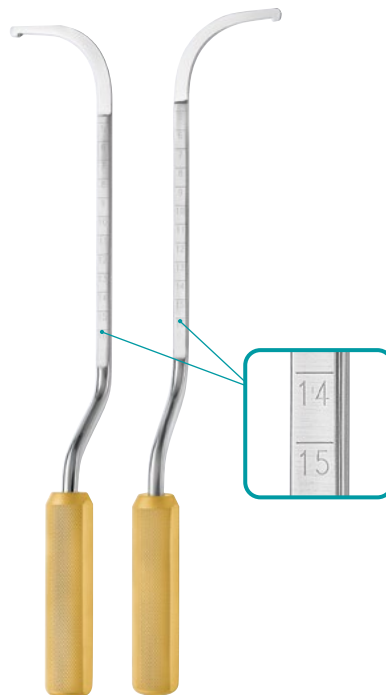

AGRIS-DINGMAN
Transaxillary Dissector Set, with scale

360mm, 14" 260-088-370



SCULPO
Breast Elevator, medium curved, insulated shaft

320mm, 12²/₃" 260-001-013

For creation of submammary pockets.



SCULPO

Breast Dissector, angled

330mm, 13"	260-010-000
420mm, 16 ¹ / ₂ "	260-010-420



SCULPO

Breast Dissector, angled, malleable shaft

330mm, 13"	260-310-000
420mm, 16 ¹ / ₂ "	260-310-420



SCULPO

Breast Dissector, angled, insulated shaft

330mm, 13"	260-010-010
420mm, 16 ¹ / ₂ "	260-010-421

Breast Dissectors

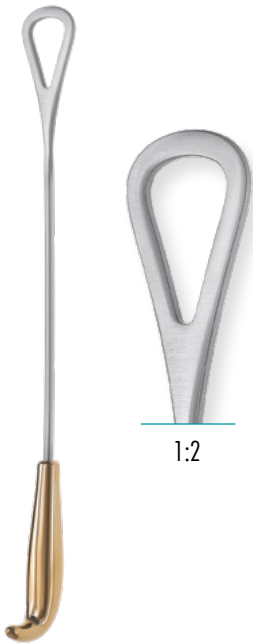

1:2

REYNOLDS

Transaxillary Breast Dissector, fenestrated blade

400mm, 15³/₄"

260-737-040

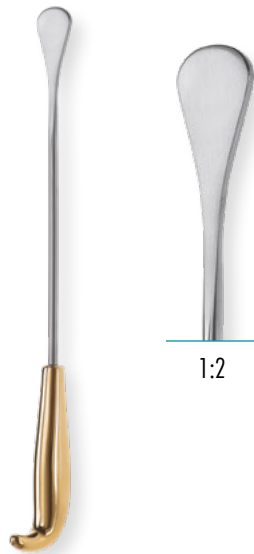

1:2

REYNOLDS

Breast Dissector, oval spatulated blade

320mm, 12²/₃"

260-140-000

420mm, 16¹/₂"

260-140-420



1:2

MACCOLLUM-DINGMAN

Breast Dissector, angled shaft

410mm, 16"

260-016-410

Designed to facilitate tissue dissection when utilizing transaxillary approach for breast augmentation. Can also be used as a subglandular or subpectoral dissector.



1:2

SCULPO

Spatulated Breast Dissector, malleable shaft

330mm, 13"

260-311-000

420mm, 16¹/₂"

260-311-420



1:2

SCULPO

Spatulated Breast Dissector

330mm, 13"

260-011-000

420mm, 16¹/₂"

260-011-420



1:2

SCULPO

Spatulated Breast Dissector

330mm, 13"

260-011-010

420mm, 16¹/₂"

260-011-421

MARKERS & CALIPERS

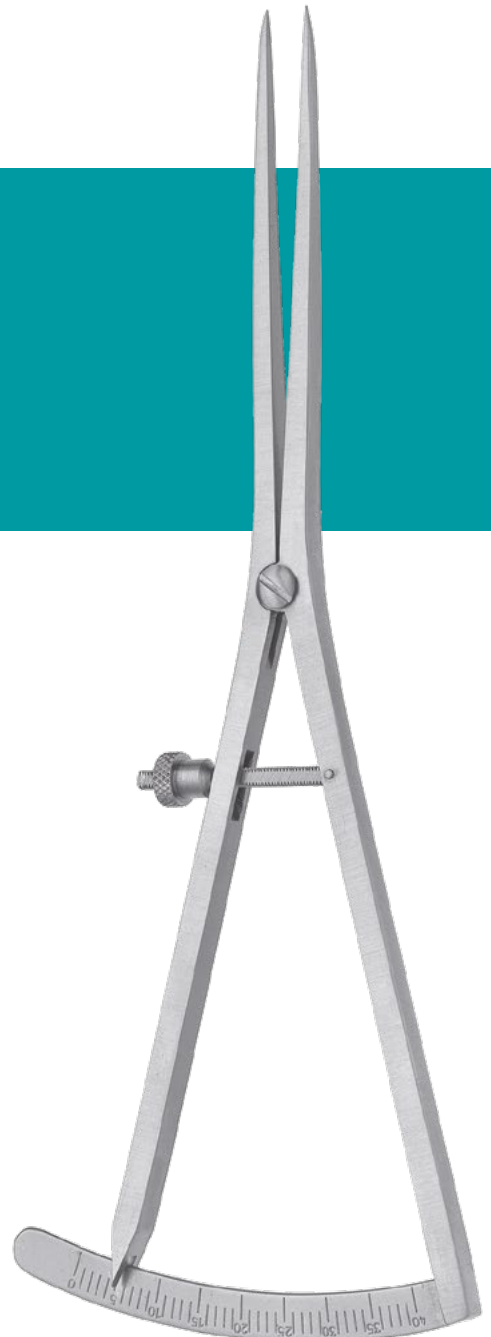



FREEMAN
Areola Marker

Ø 25mm	260-750-125
Ø 30mm	260-750-130
Ø 34mm	260-750-134
Ø 36mm	260-750-136
Ø 38mm	260-750-138

Ø 40mm	260-750-140
Ø 42mm	260-750-142
Ø 45mm	260-750-145
Ø 50mm	260-750-150
Ø 52mm	260-750-152



FREEMAN
Areola Marker, double-ended

Ø 38/42mm	260-751-125
Ø 42/45mm	260-751-142



FREEMAN
Areola Marker, double-ended, with markings

Ø 38/42mm	260-751-225
Ø 34/36mm	260-751-236
Ø 45/50mm	260-751-250



RZ
Areola Marker

Ø 36mm	260-755-036
Ø 38mm	260-755-038
Ø 42mm	260-755-042
Ø 45mm	260-755-045



GROSSMANN
Areola Marker, 4 sizes in 1, non-cutting

40/44/48/52mm	260-754-000
---------------	-------------



GALVAO
Areola Marker

Ø 40mm

260-753-040

Ø 50mm

260-753-050

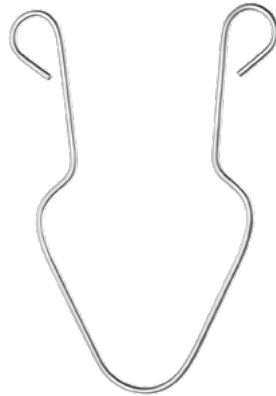

RZ
Areola Marker

100mm

260-746-000

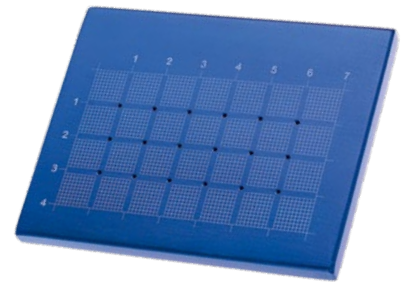

SHEEN
Cartilage grid, aluminium, blue

70x40mm

260-761-000



ECKHOFF
Skin Marking Pen, with reversible holder for point

145mm, 5^{3/4}"

420-832-145

Spare nib

1 piece

420-832-001



Ink Pot for Skin marking Pen

1 piece

420-832-000



Marking pen

10 pieces (box)

400-832-100



Used with Freeman
Areola Marker

MCKISSOCK

Breast Caliper

Ø 38 mm	260-738-000
Ø 42 mm	260-742-000
Ø 45 mm	260-745-000



HALPERN

Breast Caliper

Ø 38 mm	260-755-000
Ø 42 mm	260-757-000



CASTROVIEJO

Caliper, with locking screw

0-20mm, 85mm	400-583-007
0-40mm, 180mm	400-583-008



Ruler
with mm and inch markings

150mm, 6"	100-418-150
200mm, 8"	100-418-200
300mm, 11 ³ / ₄ "	100-418-300
500mm, 20"	100-418-500



JAMESON

Caliper with locking screw

0-80mm, 95mm	400-421-000
--------------	-------------



THORPE

Caliper, with locking screw

0-80mm, 95mm	400-420-100
--------------	-------------

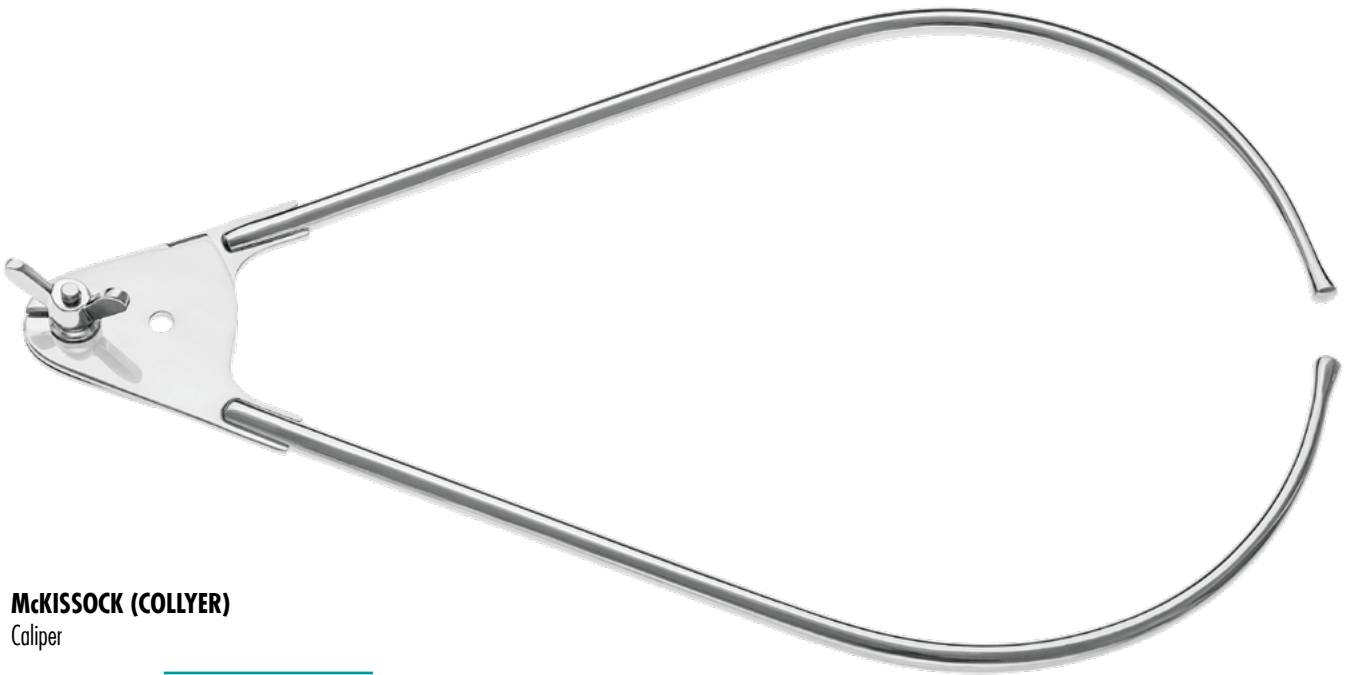
**McKISSOCK (COLLYER)**

Caliper

300mm, 12"

260-756-300

SUCTION INSTRUMENTS



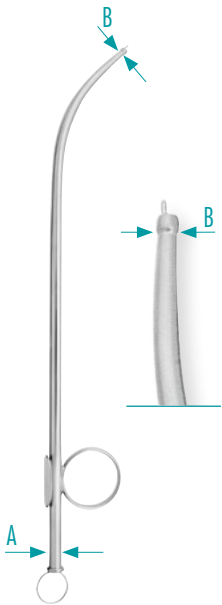

MAGILL

Suction Tube, 245mm, 9³/₄"

Order number	A	B
410-404-030	3.6mm	3.0mm
410-404-035	4.0mm	3.5mm
410-404-040	4.5mm	4.0mm

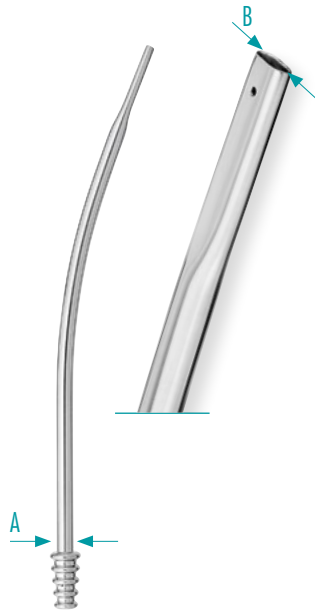

Nasal Suction Tube, Luer Lock, 180mm, 7"

Order number	A	B
165-064-160	5mm	6.5mm



Suction Cannula, fibre-optic connector, 190mm, 7¹/₂"

10 Fr.	165-523-110
12 Fr.	165-523-112

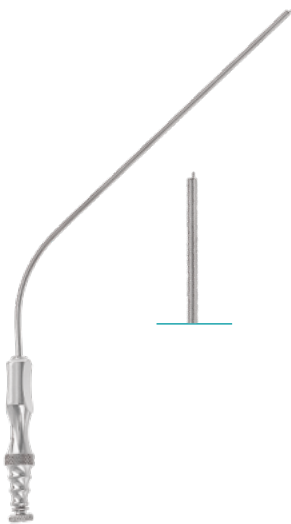

FERGUSSON

Suction Tube, 180mm, 7"

6 Fr.	165-525-006
7 Fr.	165-525-007
8 Fr.	165-525-008
10 Fr.	165-525-010
12 Fr.	165-525-012



YANKAUER

Suction Cannula, fibre-optic connector

270mm, 10 ² / ₃ "	165-743-270
---	-------------



ADSON

Suction Cannula, Ø4mm

210mm, 8 ¹ / ₄ "	165-521-004
--	-------------

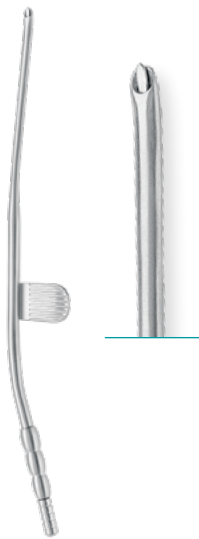

GULEN
Suction Elevator, 200mm, 8"

Right curved 165-521-200

Left curved 165-522-200



NEGUS
Suction Dissector, blunt, Ø 6mm

205mm, 8 1/8" 420-395-205



RZ
Nasal Suction Dissector, sharp, Luer Lock, Ø 8mm

190mm, 7 1/2" 420-310-190



GORNEY
Suction Raspatory, Ø 3mm, 180mm, 7"

Blunt 420-252-185

Semi-Sharp 420-253-185



Infiltration Cannula for syringes, **22 holes**, screw lock

Order number	WL	Ø Shaft
260-983-200	220mm	3mm
260-984-200	220mm	4mm

Infiltration Cannula for syringes, **30 holes**, screw lock

Order number	WL	Ø Shaft
260-983-300	220mm	3mm
260-984-300	220mm	4mm



Infiltration Cannula for syringes, **1 hole**, Luer Lock

Order number	WL	Ø Shaft
260-981-150	150mm	2mm
260-981-200	200mm	2mm
260-981-250	250mm	2mm
260-981-300	300mm	2mm
260-982-150	150mm	3mm
260-982-200	200mm	3mm
260-982-250	250mm	3mm
260-982-300	300mm	3mm

Infiltration Cannula for syringes, **22 holes**, Luer Lock

Order number	WL	Ø Shaft
260-984-150	150mm	2mm
260-984-201	200mm	2mm
260-984-250	250mm	2mm
260-984-301	300mm	2mm
260-985-150	150mm	3mm
260-985-200	200mm	3mm
260-985-250	250mm	3mm
260-985-301	300mm	3mm



Adaptor with Luer Lock connection, for use of screw lock cannulas on Luer Lock syringes

1 piece

166-972-000



With quick lock and lever mechanism

RZ
Liposuction Hand Piece, with lever mechanism

Quick lock 260-900-000

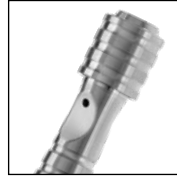

With quick lock and thumb control

RZ
Liposuction Hand Piece, with thumb control

Quick lock 260-910-000



With quick lock and without thumb control

RZ
Liposuction Hand Piece, without thumb control

Quick lock 260-911-000



With Luer lock and thumb control

RZ
Liposuction Hand Piece, with thumb control

Luer lock 260-910-100



With Luer lock and without thumb control

RZ
Liposuction Hand Piece, without thumb control

Luer lock 260-911-100



Liposuction Cannula, for Quick Lock



Liposuction Cannula, for Luer Lock



TRIPORT
for Quick Lock

Order number	WL	Ø Shaft
260-912-150	150mm	2mm
260-913-150	150mm	3mm
260-913-200	200mm	3mm
260-913-250	250mm	3mm
260-913-300	300mm	3mm
260-914-200	200mm	4mm
260-914-250	250mm	4mm
260-914-300	300mm	4mm
260-915-200	200mm	5mm
260-915-250	250mm	5mm
260-915-300	300mm	5mm
260-916-200	200mm	6mm
260-916-250	250mm	6mm
260-916-300	300mm	6mm



TRIPORT
for Luer Lock

Order number	WL	Ø Shaft
260-912-151	150mm	2mm
260-913-151	150mm	3mm
260-913-201	200mm	3mm
260-913-251	250mm	3mm
260-913-301	300mm	3mm
260-914-201	200mm	4mm
260-914-251	250mm	4mm
260-914-301	300mm	4mm
260-915-201	200mm	5mm
260-915-251	250mm	5mm
260-915-301	300mm	5mm
260-916-201	200mm	6mm
260-916-251	250mm	6mm
260-916-301	300mm	6mm



MONOPORT
for Quick Lock

Order number	WL	Ø Shaft
260-922-150	150mm	2mm
260-923-150	150mm	3mm
260-923-200	200mm	3mm
260-923-250	250mm	3mm
260-923-300	300mm	3mm
260-924-200	200mm	4mm
260-924-250	250mm	4mm
260-924-300	300mm	4mm
260-925-250	250mm	5mm
260-925-300	300mm	5mm



MONOPORT
for Luer Lock

Order number	WL	Ø Shaft
260-922-151	150mm	2mm
260-923-151	150mm	3mm
260-923-201	200mm	3mm
260-923-251	250mm	3mm
260-923-301	300mm	3mm
260-924-201	200mm	4mm
260-924-251	250mm	4mm
260-924-301	300mm	4mm
260-925-251	250mm	5mm
260-925-301	300mm	5mm



Liposuction Cannula, for Quick Lock



Liposuction Cannula, for Luer Lock



MERCEDES
for Quick Lock

Order number	WL	Ø Shaft
260-932-150	150mm	2mm
260-933-200	200mm	3mm
260-933-250	250mm	3mm
260-934-200	200mm	4mm
260-934-250	250mm	4mm
260-934-300	300mm	4mm
260-935-250	250mm	5mm
260-935-300	300mm	5mm



MERCEDES
for Luer Lock

Order number	WL	Ø Shaft
260-932-151	150mm	2mm
260-933-201	200mm	3mm
260-933-251	250mm	3mm
260-934-201	200mm	4mm
260-934-251	250mm	4mm
260-934-301	300mm	4mm
260-935-251	250mm	5mm
260-935-301	300mm	5mm



COBRA
for Quick Lock

Order number	WL	Ø Shaft
260-952-150	150mm	2mm
260-953-150	150mm	3mm
260-953-200	200mm	3mm
260-953-250	250mm	3mm
260-954-200	200mm	3mm
260-954-250	250mm	4mm
260-954-300	300mm	4mm
260-955-250	250mm	4mm
260-955-300	300mm	5mm



COBRA
for Luer Lock

Order number	WL	Ø Shaft
260-952-151	150mm	2mm
260-953-151	150mm	3mm
260-953-201	200mm	3mm
260-953-251	250mm	3mm
260-954-201	200mm	3mm
260-954-251	250mm	4mm
260-954-301	300mm	4mm
260-955-251	250mm	4mm
260-955-301	300mm	5mm



Liposuction Cannula, for Quick Lock



Liposuction Cannula, for Luer Lock



SPIRALE
for Quick Lock

Order number	WL	Ø Shaft
260-942-150	150mm	2mm
260-943-150	150mm	3mm
260-943-200	200mm	3mm
260-943-250	250mm	3mm
260-944-200	200mm	4mm
260-944-250	250mm	4mm
260-944-300	300mm	4mm
260-945-250	250mm	5mm
260-945-300	300mm	5mm



SPIRALE
for Luer Lock

Order number	WL	Ø Shaft
260-942-151	150mm	2mm
260-943-151	150mm	3mm
260-943-201	200mm	3mm
260-943-251	250mm	3mm
260-944-201	200mm	4mm
260-944-251	250mm	4mm
260-944-301	300mm	4mm
260-945-251	250mm	5mm
260-945-301	300mm	5mm



SHARK
for Quick Lock

Order number	WL	Ø Shaft
260-962-150	150mm	2mm
260-963-150	150mm	3mm
260-963-200	200mm	3mm
260-963-250	250mm	3mm
260-964-200	200mm	4mm
260-964-250	250mm	4mm
260-964-300	300mm	4mm
260-965-250	250mm	5mm
260-965-300	300mm	5mm



SHARK
for Luer Lock

Order number	WL	Ø Shaft
260-962-151	150mm	2mm
260-963-151	150mm	3mm
260-963-201	200mm	3mm
260-963-251	250mm	3mm
260-964-201	200mm	4mm
260-964-251	250mm	4mm
260-964-301	300mm	4mm
260-965-251	250mm	5mm
260-965-301	300mm	5mm



Liposuction, complete instrument, **straight**



Liposuction, complete instrument, **bayonet-shape**



Order number	WL	Ø Shaft
260-912-152	150mm	2mm
260-912-202	200mm	2mm
260-912-252	250mm	2mm
260-912-302	300mm	2mm
260-913-152	150mm	3mm
260-913-202	200mm	3mm
260-913-252	250mm	3mm
260-913-302	300mm	3mm
260-914-152	150mm	4mm
260-914-202	200mm	4mm
260-914-252	250mm	4mm
260-914-302	300mm	4mm
260-915-152	150mm	5mm
260-915-202	200mm	5mm
260-915-252	250mm	5mm
260-915-302	300mm	5mm
260-916-152	150mm	6mm
260-916-202	200mm	6mm
260-916-252	250mm	6mm
260-916-302	300mm	6mm



Order number	WL	Ø Shaft
260-912-153	150mm	2mm
260-912-203	200mm	2mm
260-912-253	250mm	2mm
260-912-303	300mm	2mm
260-913-153	150mm	3mm
260-913-203	200mm	3mm
260-913-253	250mm	3mm
260-913-303	300mm	3mm
260-914-153	150mm	4mm
260-914-203	200mm	4mm
260-914-253	250mm	4mm
260-914-303	300mm	4mm
260-915-153	150mm	5mm
260-915-203	200mm	5mm
260-915-253	250mm	5mm
260-915-303	300mm	5mm
260-916-153	150mm	6mm
260-916-203	200mm	6mm
260-916-253	250mm	6mm
260-916-303	300mm	6mm



Liposuction, complete instrument, **straight**



Liposuction, complete instrument, **bayonet-shape**



MONOPORT
straight

Order number	WL	Ø Shaft
260-922-152	150mm	2mm
260-922-202	200mm	2mm
260-922-252	250mm	2mm
260-922-302	300mm	2mm
260-923-152	150mm	3mm
260-923-202	200mm	3mm
260-923-252	250mm	3mm
260-923-302	300mm	3mm
260-924-152	150mm	4mm
260-924-202	200mm	4mm
260-924-252	250mm	4mm
260-924-302	300mm	4mm
260-925-152	150mm	5mm
260-925-202	200mm	5mm
260-925-252	250mm	5mm
260-925-302	300mm	5mm
260-926-152	150mm	6mm
260-926-202	200mm	6mm
260-926-252	250mm	6mm
260-926-302	300mm	6mm



MONOPORT
bayonet-shape

Order number	WL	Ø Shaft
260-922-153	150mm	2mm
260-922-203	200mm	2mm
260-922-253	250mm	2mm
260-922-303	300mm	2mm
260-923-153	150mm	3mm
260-923-203	200mm	3mm
260-923-253	250mm	3mm
260-923-303	300mm	3mm
260-924-153	150mm	4mm
260-924-203	200mm	4mm
260-924-253	250mm	4mm
260-924-303	300mm	4mm
260-925-153	150mm	5mm
260-925-203	200mm	5mm
260-925-253	250mm	5mm
260-925-303	300mm	5mm
260-926-153	150mm	6mm
260-926-203	200mm	6mm
260-926-253	250mm	6mm
260-926-303	300mm	6mm



Liposuction, complete instrument, **straight**



Liposuction, complete instrument, **bayonet-shape**



MERCEDES
straight

Order number	WL	Ø Shaft
260-932-152	150mm	2mm
260-932-202	200mm	2mm
260-932-252	250mm	2mm
260-932-302	300mm	2mm
260-933-152	150mm	3mm
260-933-202	200mm	3mm
260-933-252	250mm	3mm
260-933-302	300mm	3mm
260-934-152	150mm	4mm
260-934-202	200mm	4mm
260-934-252	250mm	4mm
260-934-302	300mm	4mm
260-935-152	150mm	5mm
260-935-202	200mm	5mm
260-935-252	250mm	5mm
260-935-302	300mm	5mm
260-936-152	150mm	6mm
260-936-202	200mm	6mm
260-936-252	250mm	6mm
260-936-302	300mm	6mm



MERCEDES
bayonet-shape

Order number	WL	Ø Shaft
260-932-153	150mm	2mm
260-932-203	200mm	2mm
260-932-253	250mm	2mm
260-932-303	300mm	2mm
260-933-153	150mm	3mm
260-933-203	200mm	3mm
260-933-253	250mm	3mm
260-933-303	300mm	3mm
260-934-153	150mm	4mm
260-934-203	200mm	4mm
260-934-253	250mm	4mm
260-934-303	300mm	4mm
260-935-153	150mm	5mm
260-935-203	200mm	5mm
260-935-253	250mm	5mm
260-935-303	300mm	5mm
260-936-153	150mm	6mm
260-936-203	200mm	6mm
260-936-253	250mm	6mm
260-936-303	300mm	6mm



Liposuction, complete instrument, **straight**



Liposuction, complete instrument, **bayonet-shape**



COBRA
straight

Order number	WL	Ø Shaft
260-952-152	150mm	2mm
260-952-202	200mm	2mm
260-952-252	250mm	2mm
260-952-302	300mm	2mm
260-953-152	150mm	3mm
260-953-202	200mm	3mm
260-953-252	250mm	3mm
260-953-302	300mm	3mm
260-954-152	150mm	4mm
260-954-202	200mm	4mm
260-954-252	250mm	4mm
260-954-302	300mm	4mm
260-955-152	150mm	5mm
260-955-202	200mm	5mm
260-955-252	250mm	5mm
260-955-302	300mm	5mm
260-956-152	150mm	6mm
260-956-202	200mm	6mm
260-956-252	250mm	6mm
260-956-302	300mm	6mm



COBRA
bayonet-shape

Order number	WL	Ø Shaft
260-952-153	150mm	2mm
260-952-203	200mm	2mm
260-952-253	250mm	2mm
260-952-303	300mm	2mm
260-953-153	150mm	3mm
260-953-203	200mm	3mm
260-953-253	250mm	3mm
260-953-303	300mm	3mm
260-954-153	150mm	4mm
260-954-203	200mm	4mm
260-954-253	250mm	4mm
260-954-303	300mm	4mm
260-955-153	150mm	5mm
260-955-203	200mm	5mm
260-955-253	250mm	5mm
260-955-303	300mm	5mm
260-956-153	150mm	6mm
260-956-203	200mm	6mm
260-956-253	250mm	6mm
260-956-303	300mm	6mm



Liposuction, complete instrument, **straight**



Liposuction, complete instrument, **bayonet-shape**



Order number	WL	Ø Shaft
260-942-152	150mm	2mm
260-942-202	200mm	2mm
260-942-252	250mm	2mm
260-942-302	300mm	2mm
260-943-152	150mm	3mm
260-943-202	200mm	3mm
260-943-252	250mm	3mm
260-943-302	300mm	3mm
260-944-152	150mm	4mm
260-944-202	200mm	4mm
260-944-252	250mm	4mm
260-944-302	300mm	4mm
260-945-152	150mm	5mm
260-945-202	200mm	5mm
260-945-252	250mm	5mm
260-945-302	300mm	5mm
260-946-152	150mm	6mm
260-946-202	200mm	6mm
260-946-252	250mm	6mm
260-946-302	300mm	6mm



Order number	WL	Ø Shaft
260-942-153	150mm	2mm
260-942-203	200mm	2mm
260-942-253	250mm	2mm
260-942-303	300mm	2mm
260-943-153	150mm	3mm
260-943-203	200mm	3mm
260-943-253	250mm	3mm
260-943-303	300mm	3mm
260-944-153	150mm	4mm
260-944-203	200mm	4mm
260-944-253	250mm	4mm
260-944-303	300mm	4mm
260-945-153	150mm	5mm
260-945-203	200mm	5mm
260-945-253	250mm	5mm
260-945-303	300mm	5mm
260-946-153	150mm	6mm
260-946-203	200mm	6mm
260-946-253	250mm	6mm
260-946-303	300mm	6mm



Liposuction, complete instrument, **straight**



Liposuction, complete instrument, **bayonet-shape**



SHARK
straight

Order number	WL	Ø Shaft
260-962-152	150mm	2mm
260-962-202	200mm	2mm
260-962-252	250mm	2mm
260-962-302	300mm	2mm
260-963-152	150mm	3mm
260-963-202	200mm	3mm
260-963-252	250mm	3mm
260-963-302	300mm	3mm
260-964-152	150mm	4mm
260-964-202	200mm	4mm
260-964-252	250mm	4mm
260-964-302	300mm	4mm
260-965-152	150mm	5mm
260-965-202	200mm	5mm
260-965-252	250mm	5mm
260-965-302	300mm	5mm
260-966-152	150mm	6mm
260-966-202	200mm	6mm
260-966-252	250mm	6mm
260-966-302	300mm	6mm



SHARK
bayonet-shape

Order number	WL	Ø Shaft
260-962-153	150mm	2mm
260-962-203	200mm	2mm
260-962-253	250mm	2mm
260-962-303	300mm	2mm
260-963-153	150mm	3mm
260-963-203	200mm	3mm
260-963-253	250mm	3mm
260-963-303	300mm	3mm
260-964-153	150mm	4mm
260-964-203	200mm	4mm
260-964-253	250mm	4mm
260-964-303	300mm	4mm
260-965-153	150mm	5mm
260-965-203	200mm	5mm
260-965-253	250mm	5mm
260-965-303	300mm	5mm
260-966-153	150mm	6mm
260-966-203	200mm	6mm
260-966-253	250mm	6mm
260-966-303	300mm	6mm



Syringe, with stop *

50ml	166-970-050
10ml	166-970-010

Spare cartridge for syringe *

10ml	166-970-011
------	-------------



Stop for Disposable Plastic Syringe 166-970-060 *

For 20ml	166-970-200
For 30ml	166-970-300



The stop maintains the vacuum in the syringe.

*Instruments only available without CE mark.



Lipo-Injection dosing handle

260-810-000

The Lipo-Injection dosing handle for the injection of endogenous fat into the facial area (Toledo technique) is used with standard one-way plastic syringes (20ml, 3-part with Luer-Lock connector). Suitable Injection cannulas are also available in different sizes.

Compared to the metal handle the synthetic design is much more lightweight. The accurate dosing mechanism allows to prepare very precise and delicate doses.



Illustration: Disposable syringe with injection cannula (not included)



Transfer adaptor, for the connection of two Luer Lock syringes in order to transfer the content

1 piece

166-974-000



Syringe Holding Device, for safe storage of Luer Lock syringes containing fat

1 piece

166-975-000

PREPARATION OF LIPO TRANSFER



Dismantle the disposable plastic syringe.



Attach the rubber stop to the metal fixing device.



Push the barrel over the rubber stop up to the bayonet.

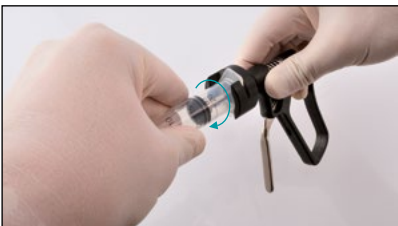

Lock the barrel by turning in the direction shown by the arrow.

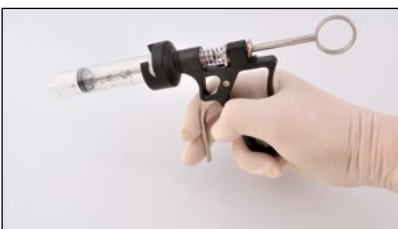

Push the rubber stop into the barrel by pressing the handle.



Set the injection cannula (with Luer Lock) on the disposable syringe and lock by turning in the direction shown by the arrow.



Finished, the Lipo-Injection is ready for application.

Please note: Lipo-Transfer as well as its preparation should only be done under sterile conditions!

DEVICES & ACCESSORIES



ELECTROSURGICAL GENERATOR



Features:

- Monopolar/bipolar cutting and coagulation
- Automatic identification of connected instruments
- Powerstart System simplifies the beginning of cutting process
- Automatic power regulation
- 105 different memory locations in 7 groups
- Various output configuration of the sockets available
- 10" Touchscreen
- Tiltable display
- Footswitch (optional)
- Available with Argon and / or the RZeal
- Real-time output monitoring

700-350-400 230V
 700-350-410 110V
 G400 ElectroSurgical Generator

DELIVERY CONTAINS:

- Main Unit
- Mains Cable
- (Footswitch not included)

Technical data

Line voltage	110-230 VAC
Power consumption	500W
Generator operation frequency	333kHz
Display	TFT 10"
Defibrillation impulse resistance	acc. to EN 60601-1
NEM system	neutral electrode control optical indication 7 levels required resistance < 240 Ω
Gas type	pure argon 4.8 (99,998%) or higher
Inlet gas pressure	0.25-0.4 [MPa]
Monopolar coagulation / cutting	200W / 400W
Bipolar coagulation / cutting	400W / 400W

Gas outflow	0.1-10 l/min, regulated 0.1 l/min in whole range
Pressure range	reducer (0.4 MPa) on argon cylinder
Vessel sealing system	9 effects/300W
AutoStop	automatic stop of sealing process after achieving the optimal effect
Dimensions	495 x 415 x 225mm (LxWxH)
Weight	12.2kg

Accessories



700-350-405
 2-Button-Footswitch, length: 5m

700-350-402
 3-Button-Footswitch, length: 5m, quick access key



Disposable Neutral Electrode
 hydrogel, split, for adults or children
 10x5 pcs. per package
 700-503-000 Adults
 700-503-001 Children



Cable for Disposable Neutral Electrode
 5m, RZ compatible only
 700-503-003

ELECTROSURGICAL GENERATOR



700-340-400 230V
 700-340-410 110V
 G44 Electro-surgical Generator

Features:

- Monopolar/bipolar cutting and coagulation
- Automatic instrument detection system
- Intuitive Touchscreen
- Automatic power regulation
- Configurable working modes
- Real-time parameter control
- Special endoscopic modes
- Bipolar resection
- Easy software update

DELIVERY CONTAINS:

- Main Unit
- Mains Cable (Footswitch not included)

Technical data

Line voltage	110-240 VAC
Power consumption	1100VA
Generator operation frequency	333kHz
Display	TFT 7" WVGA
Spectrum result system	automatic power regulation
Monopolar coagulation	max. 200W (200Ω)
Monopolar cutting	max. 400W (100Ω)
Bipolar coagulation	max. 400W (25Ω)
Bipolar cutting	max. 330W (150Ω)

NEM system	neutral electrode control, optical indication, required resistance < 240 Ω
Dimensions	385 x 305 x 141mm (LxWxH)
Weight	7kg

Accessories



700-350-405
 2-Button-Footswitch, length: 5m
 700-350-402
 3-Button-Footswitch, length: 5m, quick access key



Disposable Neutral Electrode
 hydrogel, split, for adults or children
 10x5 pcs. per package
 700-503-000 Adults
 700-503-001 Children



Cable for Disposable Neutral Electrode
 5m, RZ compatible only
 700-503-003

FULL HD CAMERA SYSTEM



Features:

- Full HD camera with 3-chip MOS technology
- Pure Natural Colors technology
- Full HD video recording (F4 only)
- Full HD image saving (F4 only)
- Camera head with 3 programmable buttons
- Boost function
- Freeze function
- 2.5x digital zoom
- 3 USER mode configurations
- Multilingual on screen menu
- Different digital video outputs
- Text generator (optional with keyboard)

300-001-800 3 Chip HD-Camera F3
 300-001-804 3 Chip HD-Camera F4 (with recording function)

DELIVERY CONTAINS:

- Main Unit
- Camera head
- 2x BNC cable
- HDMI - DVI cable
- HDMI cable
- S-Video cable (F3 only)
- USB Pen Drive (F4 only)
- Mains cable
- Operating manual

FULL HD

Technical data

Line voltage	100-240 VAC
Power input	20W
Image sensor	3 MOS
Resolution	1920 x 1080 pixels (FullHD)
Image resolution	>1000 TV lines, horizontal
Index ratio	16:9
Min. sensitivity	< 3lx (1/1.4)
Shutter speed	1/50 (1/60) to 1/100.000sec

Video outputs (F4)	2 x HD SDI 1x HDMI / DVI 2x CVBS 1 x YPbPr / RGB 1 x Y/C (Pal/NTSC) 1x CVBS (Pal/NTSC)
Video outputs (F3)	1 x HDMI / DVI 1 x YPbPr (Component) 1 x Y/C (Pal/NTSC) 1x CVBS (Pal/NTSC)
Dimensions	Control unit: 380 x 120 x 360mm (WxHxD) Weight control unit: 11kg Weight camera head: 145g

Accessories



300-001-802
High-End 3-MOS Camera Head
FullHD (included in the set)



300-001-615
Title generator keyboard, waterproof IP68
US-Layout, cable 1.8m, color: grey,
305x140x15mm, 600gr.



300-001-610
Footswitch for HD Cameras
cable length: 2m

FULL HD CAMERA SYSTEM



Features:

- Full HD camera with 1-chip MOS technology
- Natural color technology
- Full HD video recording (F2 Pro only)
- Full HD image saving (F2 Pro only)
- Camera head with 3 programmable buttons
- Boost function
- Freeze function
- 2.5x digital zoom
- 3 USER mode configurations
- Multilingual on screen menu
- HDMI video outputs
- Text generator (optional with keyboard)

300-001-600 HD-Camera F1
 300-001-601 HD-Camera F2 Pro (with recording function)

FULL HD

Technical data

Line voltage	100-240 VAC
Power input	F2 Pro: 30W / F1: 20W
Image sensor	1/3" MOS
Resolution	1920 x 1080 pixels (FullHD)
Image resolution	>1000 TV lines, horizontal
Index ratio	16:9
Min. sensitivity	< 3lx (1/1.4)

DELIVERY CONTAINS:

- Main Unit
- Camera head
- 2x BNC cable
- HDMI - DVI cable
- HDMI cable
- S-Video cable
- USB Pen Drive (F2 Pro only)
- Operating manual
- Mains cable

Video outputs (F2 Pro)	2 x HD SDI (optional) 1 x HDMI / DVI 1 x Y-Pb-Pr (Component) 1 x Video (PAL/NTSC) 1x S-Video (PAL/NTSC)
Video outputs (F1)	1 x HDMI 1 x YPbPr / RGB 1 x S-Video (Y/C; Pal / NTSC) 1 x Video (CVBS; Pal / NTSC)
Dimensions	Control unit: 380 x 120 x 360mm (WxHxD) Weight control unit: 11kg Weight camera head: 105g

Accessories



300-001-602
 High-End 1/3" MOS Camera Head
 Full HD (included in the set)



300-001-615
 Title generator keyboard, waterproof IP68
 US-Layout, cable 1.8m, color: grey,
 305x140x15mm, 600gr.



300-001-610
 Footswitch for HD Cameras
 cable length: 2m

TV COUPLER



4K
FULL HD

300-001-823 f=14mm
300-001-824 f=25mm
300-001-825 f=28mm
c-mount, soakable



4K
FULL HD

250-015-030
Zoom-TV-Adapter
f=15 - 30mm
c-mount, soakable



4K
FULL HD

250-015-036
Zoom-TV-Adapter
f=15 - 36mm
c-mount, soakable



FULL HD

300-001-813 f=14mm
300-001-814 f=25mm
300-001-815 f=28mm
c-mount, soakable



FULL HD

250-020-025 F=25mm (splitting 90/10)
250-020-030 F=30mm (splitting 90/10)
Beamsplitter, allows simultaneous video
and direct views, c-mount, soakable

LED LIGHT SOURCE



Features:

- 6500K daylight color temperature
- 375 Watt equivalent output power
- > 20.000 hours lifetime
- Turret connector for the most common light cables (Olympus, Wolf, Gyrus ACMI, Storz)
- Manual or automatic light control
- Waterproof touch control panel
- Low heat conduction by improved LED technology
- Boost function: light increase of 20%

300-900-300 LUMEN LED 3 PRO Light Source, 110 - 230V



Technical data

Line voltage	100-240 VAC
Video input	1x Video, BNC
Protection class	1 (acc. IEC 60601-1) 1 (acc. MDD 93/42/EEC)
Safety class	BF
Standard	IEC 60601-1-2
Dimensions	380 x 120 x 360mm (WxHxD)
Weight	approx. 11kg

DELIVERY CONTAINS:

- Main Unit (300-900-300)
- BNC cable (optional)
- Mains cable
- Operating manual



A OLYMPUS

B WOLF

C GYRUS ACMI

D STORZ
KARL STORZ ENDOSKOP

Turret, multi connector

LED LIGHT SOURCE



Features:

- More than 20.000h lamp lifetime
- 180 Watt equivalent power output
- Manual or automatic light control
- Waterproof touch control panel
- Low heat conduction by improved LED technology
- Daylight color temperature 6000 – 6500° K for accurate color representation
- Boost function: light increase of 20%

300-900-180 LUMEN LED 1 Light Source



DELIVERY CONTAINS:

- Main Unit (300-900-180)
- BNC cable
- Mains cable
- Operating manual

Technical data

Line voltage	100-240 VAC
Power consumption	130VA
Video input	1x Video, 1x S-Video (Y/C) (automatic version only)
Protection class	1 (acc. IEC 60601-1) 1 (acc. MDD 93/42/EEC)
Safety class	BF
Dimensions	380 x 120 x 360mm (WxHxD)
Weight	approx. 11kg

HIGH TEMPERATURE LED/XENON LIGHT CABLES



Adaptor pieces to use with **ENDOSCOPE**



250-042-000
RZ/Storz/Olympus



250-040-000
Wolf



250-041-000
ACMI/British Standard

XENON/LED Light Guide Cables
with melt and bending protection

250-025-230 Ø 2.5 mm, 2300 mm

250-025-300 Ø 2.5 mm, 3000 mm

250-035-180 Ø 3.5 mm, 1800 mm

250-035-230 Ø 3.5 mm, 2300 mm

250-035-300 Ø 3.5 mm, 3000 mm

250-048-180 Ø 4.8 mm, 1800 mm

250-048-230 Ø 4.8 mm, 2300 mm

250-048-300 Ø 4.8 mm, 3000 mm

Adaptor pieces to use with **LIGHT SOURCE**



250-039-000
RZ/Storz



250-038-000
ACMI/CUDA



250-048-000
Luxtec



250-051-000
Stryker



250-037-000
Wolf



250-044-000
Olympus



250-045-000
Olympus - Standard



250-052-000
Heine



250-059-000
Pentax



COMPATIBILITY NOTE:

A fiber optic cable with a large diameter should not be connected to a smaller diameter scope.
For example: Ø 4.8mm fiber optic cables connected to a Ø 2.9mm may risk high temperature at the light entry of the endoscope and may risk patient safety.

Order number	Page	Order number	Page	Order number	Page	Order number	Page
100-418-150	214	120-111-180	3	120-538-150	31	121-075-105	5
100-418-200	214	120-120-150	41	120-561-140	40	121-077-170	25
100-418-300	214	120-121-150	7, 41	120-565-120	54	121-077-205	25
100-418-500	214	120-131-110	42	120-568-190	20	121-081-100	51
110-090-000	163	120-131-135	7	120-569-190	20	121-089-130	51
110-090-001	163	120-132-200	50	120-570-145	22	121-091-095	49
110-090-100	163	120-133-200	50	120-570-180	22	121-093-105	35
110-090-150	163	120-135-115	9, 50	120-571-115	34	121-094-115	37
110-096-019	163	120-141-120	41	120-571-145	22	121-095-115	5, 37
110-096-119	163	120-173-180	33	120-571-180	22	121-098-100	49
110-096-180	163	120-209-180	33	120-572-170	21	121-099-100	49
110-096-185	163	120-220-090	53	120-572-190	21	121-100-120	51
110-097-305	163	120-281-110	43	120-572-230	21	121-101-120	51
110-098-305	163	120-281-130	43	120-573-170	21	121-111-145	46
110-098-399	163	120-283-130	43	120-573-190	21	121-111-180	46
110-110-003	5, 7, 9, 157	120-283-140	40	120-573-205	21	121-111-200	46
110-130-077	5	120-286-220	44	120-573-230	21	121-111-230	46
110-140-000	157	120-305-105	41	120-574-170	29	121-111-280	46
110-140-004	157	120-310-180	24	120-575-145	30	121-131-110	42
110-148-000	157	120-311-180	24	120-576-170	26	121-132-200	50
110-201-010	7	120-315-150	36	120-576-190	26	121-133-200	50
110-201-011	9	120-315-180	36	120-576-230	21	121-137-145	32
110-201-015	7, 9	120-323-110	34	120-577-170	26	121-139-135	32
120-030-170	3	120-330-145	37	120-577-205	26	121-153-145	47
120-031-170	3, 5	120-338-150	31	120-580-230	55	121-153-180	47
120-031-230	3	120-339-170	42	120-580-250	55	121-153-200	47
120-046-160	41	120-411-090	43	120-580-305	55	121-153-230	47
120-047-160	41	120-500-170	27	120-580-355	55	121-182-115	52
120-059-140	40	120-501-170	27	120-583-180	7, 44	121-183-115	52
120-061-115	53	120-501-200	27	120-584-170	19	121-184-115	52
120-065-120	38	120-506-145	48	120-584-190	19	121-185-115	52
120-065-130	38	120-506-170	48	120-584-230	19	121-186-115	52
120-065-150	38	120-506-230	48	120-585-170	19	121-187-115	52
120-065-180	38	120-507-145	7, 48	120-585-180	44	121-188-145	52
120-065-200	38	120-507-170	48	120-585-190	19	121-189-145	52
120-065-230	38	120-507-225	5	120-585-230	19	121-190-140	52
120-073-080	41	120-507-230	48	120-586-190	18	121-191-140	52
120-078-100	49	120-510-115	45	120-587-190	18	121-196-110	35
120-078-105	49	120-510-145	5, 46	120-588-220	44	121-197-110	35
120-079-105	41	120-510-180	46	120-591-140	32	121-204-200	30
120-080-095	49	120-510-200	46	120-593-115	36	121-209-180	33
120-080-115	39	120-510-230	46	120-595-180	32	121-211-180	29
120-081-095	49	120-510-280	46	120-611-115	53	121-211-200	29
120-081-115	39	120-511-115	45	120-611-140	53	121-211-230	29
120-082-100	39	120-511-145	5, 46	120-611-180	53	121-214-150	30
120-083-100	39	120-511-180	46	120-611-230	53	121-214-200	30
120-083-105	49	120-511-200	46	120-666-130	34	121-280-145	7, 42
120-084-100	43	120-511-230	46	120-667-130	34	121-290-165	44
120-084-120	53	120-511-280	46	120-966-130	34	121-296-120	51
120-091-095	9, 50	120-514-145	46	120-967-130	34	121-300-170	27
120-092-105	35	120-514-180	46	121-011-125	51	121-300-200	27
120-092-115	35	120-514-230	46	121-012-125	51	121-301-170	27
120-092-125	35	120-515-145	46	121-030-145	48	121-301-200	27
120-092-182	26	120-515-180	46	121-030-170	48	121-304-170	28
120-093-105	35	120-520-145	47	121-030-230	48	121-304-200	28
120-093-115	35	120-521-145	47	121-031-145	48	121-305-170	28
120-093-125	35	120-527-145	47	121-031-170	48	121-305-200	28
120-093-182	26	120-528-170	23	121-031-230	48	121-310-170	23
120-094-115	37	120-528-190	23	121-060-140	40	121-310-190	23
120-095-115	37	120-528-230	23	121-061-115	53	121-310-230	23
120-098-100	49	120-529-170	23	121-061-140	40	121-311-170	23
120-099-100	49	120-529-190	23	121-065-130	38	121-311-190	23
120-110-115	45	120-529-230	23	121-070-110	39	121-311-230	23
120-111-115	45	120-531-170	47	121-071-110	39	121-312-150	31

Order number	Page	Order number	Page	Order number	Page	Order number	Page
121-313-150	31	123-313-150	31	130-548-150	58	130-754-210	69
121-313-170	33	123-317-110	45	130-550-120	61	130-754-250	69
121-315-150	36	123-317-145	45	130-550-150	61	130-754-300	69
121-316-115	34	123-505-225	29	130-554-160	61	140-050-038	77
121-318-125	38	123-518-125	38	130-554-200	61	140-051-038	77
121-319-170	47	123-526-145	40	130-561-125	62	140-160-100	76
121-320-180	42	123-527-145	40	130-562-230	3	140-160-130	76
121-326-145	22	123-583-190	54	130-568-150	64	140-160-190	76
121-326-180	22	123-584-190	19	130-568-190	64	140-160-230	76
121-327-145	22	123-585-190	19	130-568-240	64	140-161-100	76
121-327-180	22	123-595-115	37	130-570-160	64	140-161-130	76
121-328-180	24	130-026-120	58	130-570-200	64	140-161-190	76
121-329-180	24	130-026-150	58	130-570-240	64	140-161-230	76
121-330-110	34	130-140-120	5, 61	130-572-160	64	140-162-190	76
121-331-110	34	130-140-150	61	130-572-200	64	140-221-425	77
121-331-150	34	130-151-180	61	130-572-240	64	140-221-426	77
121-332-150	38	130-239-150	66	130-719-150	68	140-255-125	5
121-332-180	38	130-242-120	66	130-720-150	68	140-258-090	77
121-332-200	38	130-242-150	66	130-736-175	70	140-258-125	77
121-334-190	18	130-243-120	66	130-736-200	70	140-259-090	77
121-334-230	18	130-243-150	66	130-737-175	70	140-259-125	77
121-335-190	18	130-490-100	58	130-737-200	70	140-262-125	77
121-335-230	18	130-491-100	58	130-738-180	69	140-263-125	77
121-336-190	18	130-492-100	58	130-738-210	69	140-267-140	78
121-337-185	18	130-500-100	58	130-738-250	69	140-270-120	76
121-339-127	42	130-501-100	58	130-738-300	69	140-271-120	76
121-342-190	20	130-502-100	58	130-740-120	68	140-281-140	5
121-343-190	20	130-503-100	59	130-740-145	69	140-291-140	3
121-344-170	20	130-504-100	59	130-740-180	69	140-293-140	5
121-344-190	20	130-505-100	59	130-740-210	69	140-295-160	3
121-344-230	20	130-510-250	3	130-740-250	69	140-311-185	5
121-345-170	20	130-511-110	58	130-740-300	69	140-318-130	76
121-345-190	20	130-512-150	63	130-741-180	69	140-318-140	76
121-345-230	20	130-513-110	59	130-741-210	69	140-318-160	76
121-575-145	30	130-516-170	64	130-741-250	69	140-319-130	76
122-296-110	35	130-518-145	63	130-741-300	69	140-319-140	76
122-297-110	35	130-518-160	63	130-743-250	68	140-319-160	76
122-311-180	25	130-518-170	65	130-746-120	68	140-331-200	3
122-411-135	43	130-518-180	63	130-747-145	69	140-332-200	3
122-576-170	26	130-520-150	65	130-747-180	69	140-333-140	5
122-577-170	26	130-522-145	66	130-747-210	69	140-338-140	76
122-594-115	37	130-522-150	64	130-747-250	69	140-361-280	3
122-595-115	37	130-522-160	66	130-747-300	69	140-573-090	5
123-031-170	48	130-522-180	66	130-748-180	69	140-573-110	5
123-037-170	48	130-524-150	65	130-748-210	69	140-573-130	3
123-070-115	39	130-524-180	65	130-748-250	69	140-630-190	3
123-071-115	39	130-527-120	61	130-748-300	69	150-052-250	3, 7
123-089-150	36	130-529-120	5, 65	130-749-180	68	150-055-250	5
123-111-145	46	130-529-150	65	130-749-230	68	165-064-160	218
123-111-180	46	130-532-120	63	130-750-150	9, 68	165-521-004	218
123-111-200	46	130-532-150	63	130-750-180	68	165-521-200	219
123-152-145	47	130-534-120	9, 65	130-750-230	68	165-522-130	5
123-153-145	47	130-534-150	65	130-751-150	68	165-522-200	219
123-196-110	36	130-536-150	64	130-752-180	69	165-523-110	218
123-196-120	36	130-536-175	63	130-752-210	69	165-523-112	218
123-197-110	36	130-537-120	65	130-752-250	69	165-525-006	218
123-197-120	36	130-537-150	65	130-752-300	69	165-525-007	7, 218
123-197-150	36	130-538-120	63	130-753-145	69	165-525-008	218
123-300-200	26	130-538-150	63	130-753-180	69	165-525-010	7, 218
123-301-200	26	130-541-180	64	130-753-210	69	165-525-012	218
123-305-170	28	130-542-150	63	130-753-250	69	165-743-270	218
123-305-200	28	130-542-180	63	130-753-300	69	166-970-010	231
123-311-190	24	130-542-210	63	130-754-145	69	166-970-011	231
123-312-150	31	130-548-120	58	130-754-180	69	166-970-050	231

Order number	Page	Order number	Page	Order number	Page	Order number	Page
166-970-060	231	170-687-210	5	180-560-160	82	230-155-002	154
166-970-200	231	170-687-211	204	180-560-180	82	230-155-003	154
166-970-300	231	170-711-140	100	180-560-200	82	230-160-000	154
166-972-000	220	170-714-100	100	180-561-130	82	230-160-002	154
166-974-000	232	170-715-100	100	180-561-150	82	230-160-003	154
166-975-000	232	170-720-100	100	180-561-180	82	230-160-004	154
170-010-125	90	170-723-100	100	180-561-200	82	230-160-005	154
170-011-125	90	170-749-105	100	180-561-230	82	230-160-006	154
170-014-005	7	170-750-105	100	180-562-270	3	230-160-007	154
170-014-007	7	170-879-175	93	180-567-170	85	230-160-008	154
170-014-165	91	171-130-165	96	180-567-190	85	230-160-175	95
170-015-140	9, 90	171-483-025	203	180-568-120	81	230-190-175	95
170-019-000	91	171-483-138	203	180-568-140	83	230-195-175	94
170-020-001	91	171-591-330	5	180-568-170	83	230-202-000	146
170-020-002	91	171-593-300	203	180-568-180	83	230-202-001	146
170-020-003	91	171-891-215	203	180-569-120	81	230-202-002	146
170-021-115	90	171-891-300	203	180-569-130	85	230-203-002	90
170-031-120	92	180-335-170	86	180-569-180	85	230-203-102	90
170-033-120	92	180-512-145	88	180-570-120	81	230-203-150	90
170-034-120	92	180-513-145	88	180-570-130	82	230-205-180	91
170-036-180	7, 96	180-520-145	88	180-570-160	84	230-207-180	91
170-040-160	90	180-522-145	88	180-570-200	85	230-209-180	91
170-041-001	91	180-525-135	7, 84	180-571-150	85	230-210-170	146
170-041-002	91	180-530-120	5	180-588-150	84	230-211-170	146
170-041-003	91	180-531-150	84	180-648-180	86	230-230-140	155
170-041-004	91	180-531-170	84	180-660-190	87	230-232-140	155
170-042-130	92	180-532-120	9, 81	180-661-150	87	230-236-140	155
170-042-160	9, 92	180-533-130	82	180-661-180	87	230-238-100	155
170-044-130	92	180-534-140	84	180-661-190	87	230-239-100	155
170-044-160	92	180-536-130	9, 81	180-670-125	87	230-240-140	155
170-079-175	94	180-537-130	81	180-671-115	87	230-260-200	96
170-080-001	92	180-538-130	82	180-674-160	87	230-280-160	7, 93
170-080-002	92	180-539-130	82	180-675-160	87	230-281-140	94
170-081-135	92	180-540-150	83	180-755-150	86	230-282-140	94
170-085-130	93	180-540-180	3, 83	190-165-140	54	230-780-160	93
170-086-130	93	180-540-200	83	190-165-180	54	250-015-030	240
170-122-175	92	180-540-230	83	191-165-180	54	250-015-036	240
170-123-175	92	180-540-260	83	210-019-170	124	250-020-025	240
170-130-165	96	180-542-150	84	210-240-180	124	250-020-030	240
170-136-175	94	180-544-120	81	210-244-220	124	250-025-230	243
170-213-160	93	180-545-180	85	210-262-170	124	250-025-300	243
170-214-160	93	180-545-200	85	210-263-000	124	250-035-180	243
170-215-160	5	180-545-260	85	210-264-140	7, 124	250-035-230	243
170-216-160	5	180-548-150	83	210-265-000	124	250-035-300	243
170-220-004	3	180-548-180	83	210-488-004	114	250-037-000	243
170-220-006	3	180-548-200	83	210-488-006	114	250-038-000	243
170-227-215	3	180-548-230	83	210-488-007	114	250-039-000	243
170-237-175	91	180-549-150	83	210-488-008	114	250-040-000	243
170-275-175	94	180-549-180	83	210-488-009	114	250-041-000	243
170-285-165	203	180-549-200	83	210-488-012	114	250-042-000	243
170-296-175	94	180-549-230	83	210-626-190	148	250-044-000	243
170-457-102	202	180-550-125	83	210-722-210	148	250-045-000	243
170-459-001	204	180-550-140	83	210-790-180	7, 147	250-048-000	243
170-459-002	204	180-550-160	5, 83	210-792-230	147	250-048-180	243
170-459-003	204	180-550-180	83	210-844-170	148	250-048-230	243
170-510-130	95	180-550-200	83	210-845-185	148	250-048-300	243
170-512-160	9, 95	180-550-240	83	210-975-170	161	250-051-000	243
170-513-145	95	180-550-260	83	210-976-000	161	250-052-000	243
170-513-160	95	180-550-300	83	230-140-175	95	250-059-000	243
170-581-230	202	180-550-400	83	230-151-140	154	250-264-246	88
170-581-300	202	180-555-115	81	230-152-140	154	250-264-247	88
170-653-000	204	180-558-120	81	230-153-140	154	251-010-000	140, 141, 142
170-654-007	204	180-558-135	81	230-154-140	154	251-010-100	142
170-654-030	204	180-560-130	82	230-155-001	154	251-010-400	140, 141, 142

Order number	Page	Order number	Page	Order number	Page	Order number	Page
251-140-175	170	260-013-192	97	260-080-716	190, 196	260-110-525	195, 197
251-150-175	170	260-013-201	206	260-080-725	190, 196	260-110-625	186, 196
251-340-175	170	260-014-230	175	260-080-816	193, 197	260-110-725	190, 196
251-345-175	170	260-015-198	97	260-080-825	193, 197	260-110-825	193, 197
251-660-150	88	260-016-410	5, 209	260-080-916	189, 197	260-110-925	189, 197
252-031-190	148	260-020-000	11, 173	260-080-925	189, 197	260-111-025	187, 196
252-032-190	148	260-020-001	11, 172	260-088-370	5, 207	260-118-150	95
260-001-001	11, 171	260-020-038	97	260-090-016	187, 196	260-118-151	95
260-001-002	11, 171	260-020-100	173	260-090-024	187, 196	260-120-025	187, 196
260-001-013	207	260-020-101	172	260-090-027	187, 196	260-120-125	188, 196
260-001-101	171	260-020-201	172	260-090-030	187, 196	260-120-225	191, 196
260-001-102	171	260-021-000	11, 174	260-090-116	188, 196	260-120-325	192, 196
260-001-201	171	260-021-100	174	260-090-124	188, 196	260-120-425	194, 197
260-001-250	205	260-021-200	174	260-090-127	188, 196	260-120-525	195, 197
260-002-001	11, 171	260-022-000	11, 174	260-090-130	188, 196	260-120-625	186, 196
260-002-002	175	260-022-100	174	260-090-216	191, 196	260-120-725	190, 196
260-002-003	172	260-022-200	174	260-090-224	191, 196	260-120-825	193, 197
260-002-005	176	260-023-000	11, 172	260-090-227	191, 196	260-120-925	189, 197
260-002-015	176	260-023-100	172	260-090-230	191, 196	260-130-000	198
260-002-101	171	260-023-200	172	260-090-316	192, 196	260-130-014	198
260-002-103	172	260-024-000	11, 172	260-090-324	192, 196	260-130-015	198
260-002-201	171	260-024-100	172	260-090-327	192, 196	260-130-016	198
260-002-203	172	260-024-200	172	260-090-330	192, 196	260-130-110	202
260-002-300	205	260-025-000	11	260-090-416	194, 197	260-130-116	188, 196
260-003-001	11, 173	260-025-100	173	260-090-425	194, 197	260-130-160	198
260-003-002	11, 175	260-025-205	205	260-090-427	194, 197	260-130-316	192, 196
260-003-003	11, 175	260-026-100	175	260-090-430	194, 197	260-130-416	194, 197
260-003-101	173	260-030-110	202	260-090-516	195, 197	260-130-516	195, 197
260-003-201	173	260-037-000	200	260-090-524	195, 197	260-130-616	186, 196
260-004-001	11, 173	260-039-000	200	260-090-527	195, 197	260-130-716	190, 196
260-004-101	173	260-070-016	187, 196	260-090-530	195, 197	260-130-816	193, 197
260-004-201	173	260-070-025	187, 196	260-090-616	186, 196	260-130-916	189, 197
260-006-001	176	260-070-116	188, 196	260-090-624	186, 196	260-134-130	191, 196
260-007-001	171	260-070-125	188, 196	260-090-627	186, 196	260-135-000	199
260-007-101	171	260-070-216	191, 196	260-090-630	186, 196	260-135-004	199
260-008-002	11, 176	260-070-225	191, 196	260-090-716	190, 196	260-135-005	199
260-008-003	11, 176	260-070-316	192, 196	260-090-724	190, 196	260-135-300	198
260-008-005	175	260-070-325	192, 196	260-090-727	190, 196	260-137-010	199
260-008-007	175	260-070-416	194, 197	260-090-730	190, 196	260-138-000	200
260-009-000	207	260-070-425	194, 197	260-090-816	193, 197	260-140-000	209
260-010-000	5, 208	260-070-516	195, 197	260-090-824	193, 197	260-140-420	209
260-010-010	208	260-070-525	195, 197	260-090-827	193, 197	260-145-000	199
260-010-420	208	260-070-616	186, 196	260-090-830	193, 197	260-145-250	199
260-010-421	208	260-070-625	186, 196	260-090-916	189, 197	260-150-016	187, 196
260-011-000	5, 209	260-070-716	190, 196	260-090-924	189, 197	260-150-025	187, 196
260-011-010	209	260-070-725	190, 196	260-090-927	189, 197	260-150-030	187, 196
260-011-420	209	260-070-816	193, 197	260-090-930	189, 197	260-150-036	187, 196
260-011-421	209	260-070-825	193, 197	260-100-025	187, 196	260-150-116	188, 196
260-012-191	98	260-070-916	189, 197	260-100-125	188, 196	260-150-125	5, 188, 196
260-012-192	97	260-070-925	189, 197	260-100-225	191, 196	260-150-130	188, 196
260-012-193	98	260-080-016	187, 196	260-100-325	192, 196	260-150-136	188, 196
260-012-194	98	260-080-025	187, 196	260-100-425	194, 197	260-150-216	191, 196
260-012-195	98	260-080-116	188, 196	260-100-525	195, 197	260-150-225	191, 196
260-012-198	97	260-080-125	188, 196	260-100-625	186, 196	260-150-230	191, 196
260-012-199	206	260-080-216	191, 196	260-100-725	190, 196	260-150-236	191, 196
260-012-200	206	260-080-225	191, 196	260-100-825	193, 197	260-150-316	192, 196
260-012-201	206	260-080-316	192, 196	260-100-925	189, 197	260-150-325	192, 196
260-012-202	206	260-080-325	192, 196	260-104-030	11, 170, 184	260-150-330	192, 196
260-012-205	205	260-080-416	194, 197	260-110-000	184	260-150-336	192, 196
260-012-210	99	260-080-425	194, 197	260-110-030	184	260-150-416	194, 197
260-012-212	99	260-080-516	195, 197	260-110-125	188, 196	260-150-425	194, 197
260-012-230	207	260-080-525	195, 197	260-110-225	191, 196	260-150-430	194, 197
260-012-398	97	260-080-616	186, 196	260-110-325	192, 196	260-150-436	194, 197
260-013-191	98	260-080-625	186, 196	260-110-425	194, 197	260-150-516	195, 197

Order number	Page	Order number	Page	Order number	Page	Order number	Page
260-150-525	195, 197	260-190-736	190, 196	260-520-026	78	260-910-000	221
260-150-530	195, 197	260-190-825	193, 197	260-525-205	205	260-910-100	221
260-150-536	195, 197	260-190-836	193, 197	260-591-300	203	260-911-000	221
260-150-616	186, 196	260-190-925	189, 197	260-600-100	181	260-911-100	221
260-150-625	186, 196	260-190-936	189, 197	260-603-380	205	260-912-150	222
260-150-630	186, 196	260-200-110	99	260-603-450	205	260-912-151	222
260-150-636	186, 196	260-202-105	174	260-604-100	181	260-912-152	225
260-150-716	190, 196	260-203-600	11, 177	260-608-100	181	260-912-153	225
260-150-725	190, 196	260-203-700	11, 177	260-610-100	181	260-912-202	225
260-150-730	190, 196	260-203-800	11, 177	260-614-100	181	260-912-203	225
260-150-736	190, 196	260-204-100	177	260-615-100	181	260-912-252	225
260-150-816	193, 197	260-204-200	177	260-650-150	56	260-912-253	225
260-150-825	193, 197	260-204-300	11, 177	260-651-150	56	260-912-302	225
260-150-830	193, 197	260-204-327	177	260-652-150	56	260-912-303	225
260-150-836	193, 197	260-204-400	11, 177	260-653-150	56	260-913-150	222
260-150-916	189, 197	260-204-427	177	260-654-150	56	260-913-151	222
260-150-925	189, 197	260-204-500	177	260-655-150	56	260-913-152	225
260-150-930	189, 197	260-204-600	11, 177	260-656-150	56	260-913-153	225
260-150-936	189, 197	260-204-627	177	260-657-150	56	260-913-200	222
260-180-016	187, 196	260-210-130	98	260-658-150	56	260-913-201	222
260-180-025	187, 196	260-220-025	187, 196	260-659-150	56	260-913-202	225
260-180-030	187, 196	260-220-125	188, 196	260-660-150	56	260-913-203	225
260-180-116	188, 196	260-220-225	191, 196	260-661-150	56	260-913-250	222
260-180-125	188, 196	260-220-325	192, 196	260-663-150	56	260-913-251	222
260-180-130	188, 196	260-220-425	194, 197	260-700-000	11, 183	260-913-252	225
260-180-216	191, 196	260-220-525	195, 197	260-702-000	11, 182	260-913-253	225
260-180-225	191, 196	260-220-625	186, 196	260-710-000	5, 183	260-913-300	222
260-180-230	191, 196	260-220-725	190, 196	260-711-110	100	260-913-301	222
260-180-316	192, 196	260-220-825	193, 197	260-712-000	5, 182	260-913-302	225
260-180-325	192, 196	260-220-925	189, 197	260-737-040	209	260-913-303	225
260-180-330	192, 196	260-230-019	187, 196	260-738-000	5, 214	260-914-152	225
260-180-416	194, 197	260-230-110	202	260-742-000	5, 214	260-914-153	225
260-180-425	194, 197	260-233-145	78	260-745-000	5, 214	260-914-200	222
260-180-430	194, 197	260-234-145	78	260-746-000	213	260-914-201	222
260-180-516	195, 197	260-267-155	78	260-750-125	212	260-914-202	225
260-180-525	195, 197	260-267-260	78	260-750-130	212	260-914-203	225
260-180-530	195, 197	260-268-310	78	260-750-134	212	260-914-250	222
260-180-616	186, 196	260-268-410	78	260-750-136	212	260-914-251	222
260-180-625	186, 196	260-293-300	198	260-750-138	5, 212	260-914-252	225
260-180-630	186, 196	260-310-000	208	260-750-140	212	260-914-253	225
260-180-716	190, 196	260-310-420	208	260-750-142	5, 212	260-914-300	222
260-180-725	190, 196	260-311-000	209	260-750-145	5, 212	260-914-301	222
260-180-730	190, 196	260-311-420	209	260-750-150	212	260-914-302	225
260-180-816	193, 197	260-400-220	206	260-750-152	212	260-914-303	225
260-180-825	193, 197	260-400-310	207	260-751-125	212	260-915-152	225
260-180-830	193, 197	260-400-315	5, 207	260-751-142	212	260-915-153	225
260-180-916	189, 197	260-401-310	207	260-751-225	212	260-915-200	222
260-180-925	189, 197	260-418-100	99	260-751-236	212	260-915-201	222
260-180-930	189, 197	260-418-120	99	260-751-250	212	260-915-202	225
260-190-025	187, 196	260-438-315	207	260-753-040	213	260-915-203	225
260-190-036	187, 196	260-459-001	204	260-753-050	213	260-915-250	222
260-190-125	188, 196	260-459-002	204	260-754-000	212	260-915-251	222
260-190-136	188, 196	260-459-003	204	260-755-000	214	260-915-252	225
260-190-225	191, 196	260-500-001	7, 107	260-755-036	212	260-915-253	225
260-190-236	191, 196	260-501-120	7, 99	260-755-038	212	260-915-300	222
260-190-325	192, 196	260-501-180	11, 170	260-755-042	212	260-915-301	222
260-190-336	192, 196	260-501-185	170	260-755-045	212	260-915-302	225
260-190-425	194, 197	260-502-120	99	260-756-300	215	260-915-303	225
260-190-436	194, 197	260-502-180	170	260-757-000	214	260-916-152	225
260-190-525	195, 197	260-502-185	170	260-761-000	213	260-916-153	225
260-190-536	195, 197	260-512-205	205	260-800-011	164	260-916-200	222
260-190-625	186, 196	260-520-010	78	260-800-015	164	260-916-201	222
260-190-636	186, 196	260-520-016	78	260-810-000	232	260-916-202	225
260-190-725	190, 196	260-520-020	78	260-900-000	221	260-916-203	225

Order number	Page	Order number	Page	Order number	Page	Order number	Page
260-916-250	222	260-926-252	226	260-942-202	229	260-953-150	223
260-916-251	222	260-926-253	226	260-942-203	229	260-953-151	223
260-916-252	225	260-926-302	226	260-942-252	229	260-953-152	228
260-916-253	225	260-926-303	226	260-942-253	229	260-953-153	228
260-916-300	222	260-932-150	223	260-942-302	229	260-953-200	223
260-916-301	222	260-932-151	223	260-942-303	229	260-953-201	223
260-916-302	225	260-932-152	227	260-943-150	224	260-953-202	228
260-916-303	225	260-932-153	227	260-943-151	224	260-953-203	228
260-922-150	222	260-932-202	227	260-943-152	229	260-953-250	223
260-922-151	222	260-932-203	227	260-943-153	229	260-953-251	223
260-922-152	226	260-932-252	227	260-943-200	224	260-953-252	228
260-922-153	226	260-932-253	227	260-943-201	224	260-953-253	228
260-922-202	226	260-932-302	227	260-943-202	229	260-953-302	228
260-922-203	226	260-932-303	227	260-943-203	229	260-953-303	228
260-922-252	226	260-933-152	227	260-943-250	224	260-954-152	228
260-922-253	226	260-933-153	227	260-943-251	224	260-954-153	228
260-922-302	226	260-933-200	223	260-943-252	229	260-954-200	223
260-922-303	226	260-933-201	223	260-943-253	229	260-954-201	223
260-923-150	222	260-933-202	227	260-943-302	229	260-954-202	228
260-923-151	222	260-933-203	227	260-943-303	229	260-954-203	228
260-923-152	226	260-933-250	223	260-944-152	229	260-954-250	223
260-923-153	226	260-933-251	223	260-944-153	229	260-954-251	223
260-923-200	222	260-933-252	227	260-944-200	224	260-954-252	228
260-923-201	222	260-933-253	227	260-944-201	224	260-954-253	228
260-923-202	226	260-933-302	227	260-944-202	229	260-954-300	223
260-923-203	226	260-933-303	227	260-944-203	229	260-954-301	223
260-923-250	222	260-934-152	227	260-944-250	224	260-954-302	228
260-923-251	222	260-934-153	227	260-944-251	224	260-954-303	228
260-923-252	226	260-934-200	223	260-944-252	229	260-955-152	228
260-923-253	226	260-934-201	223	260-944-253	229	260-955-153	228
260-923-300	222	260-934-202	227	260-944-300	224	260-955-202	228
260-923-301	222	260-934-203	227	260-944-301	224	260-955-203	228
260-923-302	226	260-934-250	223	260-944-302	229	260-955-250	223
260-923-303	226	260-934-251	223	260-944-303	229	260-955-251	223
260-924-152	226	260-934-252	227	260-945-152	229	260-955-252	228
260-924-153	226	260-934-253	227	260-945-153	229	260-955-253	228
260-924-200	222	260-934-300	223	260-945-202	229	260-955-300	223
260-924-201	222	260-934-301	223	260-945-203	229	260-955-301	223
260-924-202	226	260-934-302	227	260-945-250	224	260-955-302	228
260-924-203	226	260-934-303	227	260-945-251	224	260-955-303	228
260-924-250	222	260-935-152	227	260-945-252	229	260-956-152	228
260-924-251	222	260-935-153	227	260-945-253	229	260-956-153	228
260-924-252	226	260-935-202	227	260-945-300	224	260-956-202	228
260-924-253	226	260-935-203	227	260-945-301	224	260-956-203	228
260-924-300	222	260-935-250	223	260-945-302	229	260-956-252	228
260-924-301	222	260-935-251	223	260-945-303	229	260-956-253	228
260-924-302	226	260-935-252	227	260-946-152	229	260-956-302	228
260-924-303	226	260-935-253	227	260-946-153	229	260-956-303	228
260-925-152	226	260-935-300	223	260-946-202	229	260-962-150	224
260-925-153	226	260-935-301	223	260-946-203	229	260-962-151	224
260-925-202	226	260-935-302	227	260-946-252	229	260-962-152	230
260-925-203	226	260-935-303	227	260-946-253	229	260-962-153	230
260-925-250	222	260-936-152	227	260-946-302	229	260-962-202	230
260-925-251	222	260-936-153	227	260-946-303	229	260-962-203	230
260-925-252	226	260-936-202	227	260-952-150	223	260-962-252	230
260-925-253	226	260-936-203	227	260-952-151	223	260-962-253	230
260-925-300	222	260-936-252	227	260-952-152	228	260-962-302	230
260-925-301	222	260-936-253	227	260-952-153	228	260-962-303	230
260-925-302	226	260-936-302	227	260-952-202	228	260-963-150	224
260-925-303	226	260-936-303	227	260-952-203	228	260-963-151	224
260-926-152	226	260-942-150	224	260-952-252	228	260-963-152	230
260-926-153	226	260-942-151	224	260-952-253	228	260-963-153	230
260-926-202	226	260-942-152	229	260-952-302	228	260-963-200	224
260-926-203	226	260-942-153	229	260-952-303	228	260-963-201	224

Order number	Page	Order number	Page	Order number	Page	Order number	Page
260-963-202	230	260-990-003	6, 7	400-137-050	60	420-135-075	138
260-963-203	230	260-990-004	8, 9	400-137-055	60	420-135-090	138
260-963-250	224	260-990-005	10, 11	400-137-150	60	420-136-020	136
260-963-251	224	260-990-999	198	400-139-050	60	420-136-035	136
260-963-252	230	290-552-160	61	400-348-135	88	420-136-055	136
260-963-253	230	290-850-160	70	400-350-135	88	420-136-070	136
260-963-302	230	290-850-200	70	400-420-100	214	420-136-080	136
260-963-303	230	290-850-240	70	400-421-000	214	420-136-090	136
260-964-152	230	290-850-300	70	400-583-007	214	420-138-040	135
260-964-153	230	290-851-160	70	400-583-008	214	420-138-055	7, 135
260-964-200	224	290-851-200	70	400-602-267	9	420-138-075	135
260-964-201	224	290-851-240	70	400-832-100	213	420-138-090	135
260-964-202	230	290-851-300	70	400-850-240	100	420-139-035	135
260-964-203	230	290-852-160	70	400-850-255	9, 100	420-139-055	135
260-964-250	224	290-852-200	70	400-850-265	100	420-139-075	135
260-964-251	224	290-852-240	70	410-033-100	162	420-140-035	140
260-964-252	230	290-852-300	70	410-033-130	162	420-140-050	140
260-964-253	230	290-853-160	70	410-033-131	162	420-140-075	140
260-964-300	224	290-853-200	70	410-033-132	162	420-140-090	140
260-964-301	224	290-853-240	70	410-033-133	162	420-140-100	140
260-964-302	230	290-853-300	70	410-391-140	59	420-140-135	132
260-964-303	230	290-854-160	70	410-395-190	7, 59	420-141-040	134
260-965-152	230	290-854-200	70	410-396-190	59	420-141-055	134
260-965-153	230	290-854-240	70	410-404-030	218	420-141-075	134
260-965-202	230	290-854-300	70	410-404-035	218	420-141-090	134
260-965-203	230	300-001-600	239	410-404-040	218	420-142-135	132
260-965-250	224	300-001-601	239	420-050-001	126	420-143-040	134
260-965-251	224	300-001-602	239	420-050-002	126	420-143-055	134
260-965-252	230	300-001-610	238, 239	420-050-003	126	420-143-075	134
260-965-253	230	300-001-615	238, 239	420-050-004	126	420-143-090	134
260-965-300	224	300-001-800	238	420-050-005	126	420-144-040	134
260-965-301	224	300-001-802	238	420-050-006	126	420-144-055	134
260-965-302	230	300-001-804	238	420-050-007	126	420-144-075	134
260-965-303	230	300-001-813	240	420-050-101	126	420-144-090	134
260-966-152	230	300-001-814	240	420-050-102	126	420-146-040	137
260-966-153	230	300-001-815	240	420-050-103	126	420-146-055	137
260-966-202	230	300-001-823	240	420-050-104	126	420-146-075	137
260-966-203	230	300-001-824	240	420-050-105	126	420-146-090	137
260-966-252	230	300-001-825	240	420-050-106	126	420-146-152	133
260-966-253	230	300-750-101	180	420-050-107	126	420-146-153	133
260-966-302	230	300-750-103	180	420-052-001	127	420-147-040	137
260-966-303	230	300-750-105	180	420-052-002	127	420-147-055	137
260-981-150	220	300-750-106	180	420-052-003	127	420-147-075	137
260-981-200	220	300-860-100	74	420-052-004	127	420-147-090	137
260-981-250	220	300-860-111	74	420-057-160	151	420-147-140	133
260-981-300	220	300-900-180	242	420-100-001	128	420-148-040	134
260-982-150	220	300-900-300	241	420-100-002	128	420-148-055	134
260-982-200	220	310-012-150	5	420-100-003	128	420-148-075	134
260-982-250	220	310-014-150	3, 77	420-119-001	131	420-148-090	134
260-982-300	220	310-014-190	77	420-119-002	131	420-148-150	133
260-983-200	220	310-022-140	77	420-119-003	131	420-150-001	141
260-983-300	220	400-018-005	58	420-120-150	129	420-150-002	141
260-984-150	220	400-022-090	60	420-122-150	129	420-150-003	141
260-984-200	220	400-025-110	62	420-123-150	129	420-150-004	141
260-984-201	220	400-029-012	62	420-124-029	130	420-150-005	141
260-984-250	220	400-082-100	59	420-124-033	130	420-150-006	141
260-984-300	220	400-083-100	59	420-124-037	130	420-150-007	141
260-984-301	220	400-084-100	62	420-132-035	138	420-150-008	141
260-985-150	220	400-118-005	59	420-132-055	138	420-150-101	140
260-985-200	220	400-137-003	60	420-132-075	138	420-150-102	140
260-985-250	220	400-137-012	60	420-132-090	138	420-150-105	140
260-985-301	220	400-137-021	60	420-134-050	136	420-150-106	140
260-990-001	2, 3	400-137-030	9, 60	420-135-035	138	420-150-107	140
260-990-002	4, 5	400-137-031	60	420-135-055	138	420-150-108	140

Order number	Page	Order number	Page	Order number	Page	Order number	Page
420-150-150	132	420-487-015	114	420-523-140	95	420-650-101	104
420-150-201	142	420-488-200	103	420-523-141	95	420-652-100	150
420-150-202	142	420-490-210	103	420-530-165	7, 144	420-653-000	104
420-150-203	142	420-491-000	113	420-531-165	144	420-654-180	106
420-150-204	142	420-491-001	113	420-532-165	144	420-655-180	106
420-150-205	142	420-491-002	113	420-532-200	7, 145	420-656-180	106
420-150-206	142	420-491-165	102	420-550-230	7, 144	420-657-180	106
420-150-301	141	420-491-210	103	420-551-170	115	420-660-000	105
420-150-302	141	420-491-230	102	420-551-200	145	420-660-100	107
420-183-150	5	420-492-165	102	420-551-210	145	420-660-101	107
420-184-100	99	420-492-210	103	420-552-170	114	420-660-102	107
420-185-100	99	420-492-230	102	420-552-215	7, 146	420-660-103	107
420-189-210	145	420-493-165	102	420-553-170	144	420-660-104	107
420-190-003	146	420-493-210	103	420-555-195	145	420-660-105	107
420-191-003	7, 146	420-493-230	102	420-557-170	145	420-660-106	107
420-195-150	162	420-494-165	102	420-568-002	7, 111	420-660-107	107
420-205-160	7, 162	420-494-210	103	420-568-004	7, 111	420-660-108	107
420-220-212	147	420-494-230	102	420-568-006	7, 111	420-660-109	107
420-220-220	147	420-495-003	111	420-568-008	111	420-660-110	107
420-221-200	147	420-495-004	111	420-568-010	111	420-660-110	107
420-235-110	150	420-495-005	111	420-580-002	110	420-660-150	107
420-236-110	150	420-495-165	102	420-580-003	110	420-660-200	107
420-237-095	150	420-495-210	103	420-580-004	110	420-660-214	7, 103
420-237-195	150	420-495-230	102	420-580-007	110	420-660-216	103
420-238-095	150	420-496-165	102	420-580-009	110	420-660-218	7, 103
420-238-195	150	420-496-210	103	420-580-012	110	420-660-219	103
420-239-090	150	420-496-230	102	420-580-145	167	420-660-220	103
420-239-095	150	420-497-165	102	420-581-140	167	420-660-500	107
420-239-190	150	420-497-210	103	420-582-003	115	420-661-000	105
420-239-195	150	420-497-230	102	420-582-045	115	420-661-100	105
420-250-160	7, 151	420-498-004	112	420-582-140	167	420-662-001	105
420-252-185	219	420-498-006	112	420-583-145	167	420-662-002	105
420-253-185	219	420-498-008	112	420-585-160	144	420-668-210	104
420-255-160	151	420-498-165	102	420-587-008	112	420-669-210	104
420-257-160	150	420-498-210	103	420-587-010	112	420-670-210	106
420-310-190	219	420-498-230	102	420-587-012	112	420-672-000	7, 104
420-364-000	149	420-499-165	102	420-587-014	112	420-672-004	104
420-365-000	7, 149	420-499-210	103	420-587-016	112	420-677-210	105
420-366-000	149	420-500-165	102	420-589-008	112	420-678-190	107
420-367-000	149	420-500-200	110	420-589-010	112	420-690-200	106
420-392-003	146	420-501-002	111	420-589-012	112	420-691-200	106
420-392-004	146	420-501-004	111	420-589-014	112	420-692-200	106
420-392-005	146	420-501-006	111	420-589-016	112	420-700-001	120
420-395-205	7, 219	420-501-008	111	420-594-002	110	420-700-002	120
420-450-230	147	420-501-010	111	420-594-003	110	420-700-020	120
420-451-230	147	420-501-012	111	420-594-004	110	420-700-022	120
420-452-230	147	420-501-015	111	420-594-005	110	420-700-025	120
420-455-230	147	420-502-002	116	420-594-006	110	420-700-030	120
420-459-001	113	420-502-003	116	420-594-008	110	420-700-100	120
420-459-002	7, 113	420-502-005	116	420-594-009	110	420-700-120	120
420-459-003	7, 113	420-502-007	116	420-594-010	110	420-700-140	120
420-459-101	113	420-502-010	116	420-594-011	110	420-700-200	121
420-459-102	113	420-502-015	116	420-594-012	110	420-700-210	120
420-459-103	113	420-502-018	116	420-594-015	110	420-700-330	121
420-460-004	112	420-502-210	116	420-639-001	113	420-700-340	122
420-460-005	112	420-502-211	116	420-639-002	113	420-700-400	121
420-480-200	103	420-502-215	116	420-639-003	113	420-700-430	120
420-481-215	144	420-502-216	116	420-640-001	113	420-700-501	121
420-485-005	113	420-503-011	110	420-640-002	113	420-700-502	121
420-486-005	113	420-507-010	111	420-640-003	113	420-700-610	122
420-487-005	113	420-520-140	95	420-650-001	106	420-700-611	122
420-487-009	114	420-520-141	95	420-650-002	106	420-700-620	122
420-487-011	114	420-520-170	107	420-650-050	104	420-700-630	122
420-487-013	114	420-521-170	107	420-650-100	7, 104	420-700-640	122
						420-700-650	122

Order number	Page	Order number	Page	Order number	Page	Order number	Page
420-700-700	121	510-050-120	161	700-031-150	72	700-101-130	74
420-743-040	139	510-200-115	159	700-031-180	72	700-101-150	74
420-743-055	139	510-205-115	158	700-031-200	72	700-101-230	74
420-743-075	139	510-210-140	159	700-031-220	72	700-101-250	74
420-743-090	139	510-215-140	159	700-032-150	72	700-102-030	74
420-752-100	150	510-220-100	160	700-032-180	72	700-103-030	74
420-756-180	106	510-224-140	158	700-032-200	72	700-103-050	74
420-832-000	213	510-225-140	158	700-032-220	72	700-104-050	74
420-832-001	213	510-225-142	158	700-033-150	72	700-105-030	74
420-832-145	213	510-226-140	158	700-033-180	72	700-200-130	74
420-985-013	168	510-226-142	158	700-033-200	72	700-200-132	74
420-985-014	168	510-227-140	158	700-033-220	72	700-200-150	74
420-985-015	168	510-245-100	160	700-040-150	72	700-200-152	74
420-990-004	119	510-250-110	160	700-040-180	72	700-280-030	74
430-100-600	166	510-251-130	160	700-040-200	72	700-280-050	74
430-100-601	166	510-332-150	158	700-040-220	72	700-285-030	74
430-100-602	166	510-334-140	161	700-041-150	72	700-285-050	74
430-100-603	166	510-337-160	159	700-041-180	72	700-286-030	74
430-100-604	166	510-338-150	159	700-041-200	72	700-286-050	74
430-105-001	166	510-347-130	158	700-041-220	72	700-286-130	74
430-105-002	166	510-425-090	161	700-042-150	72	700-286-230	74
430-105-003	166	510-460-000	161	700-042-180	72	700-287-030	74
430-297-140	201	510-460-001	161	700-042-200	72	700-287-050	74
430-297-150	201	510-460-002	161	700-042-220	72	700-287-130	74
430-397-140	201	510-460-003	161	700-043-150	72	700-287-150	74
430-397-150	201	510-462-130	160	700-043-180	72	700-287-230	74
430-497-141	201	510-463-140	160	700-043-200	72	700-287-250	74
430-497-151	201	510-464-140	160	700-043-220	72	700-290-030	74
430-531-170	146	700-010-150	72	700-050-180	73	700-290-050	74
430-532-170	146	700-010-180	72	700-050-200	73	700-291-030	74
430-797-140	201	700-010-200	72	700-050-220	73	700-291-050	74
430-797-141	201	700-010-220	72	700-052-150	73	700-292-030	74
430-797-150	201	700-011-150	72	700-052-180	73	700-293-030	74
430-797-151	201	700-011-180	72	700-052-200	73	700-293-033	74
430-797-155	202	700-011-200	72	700-052-220	73	700-293-035	74
431-200-001	167	700-011-220	72	700-060-180	73	700-300-003	74
431-200-003	167	700-012-150	72	700-060-200	73	700-300-005	74
431-200-011	167	700-012-180	72	700-060-220	73	700-300-203	74
431-200-013	167	700-012-200	72	700-062-150	73	700-300-205	74
431-200-021	167	700-012-220	72	700-062-180	73	700-300-403	74
431-200-023	167	700-013-150	72	700-062-200	73	700-300-405	74
431-200-027	167	700-013-180	72	700-062-220	73	700-340-400	237
431-200-100	166	700-013-200	72	700-070-180	73	700-340-410	237
431-630-006	144	700-013-220	72	700-070-200	73	700-345-003	74
431-630-007	144	700-020-150	72	700-070-220	73	700-345-005	74
431-630-009	144	700-020-180	72	700-072-150	73	700-345-403	74
431-630-011	144	700-020-200	72	700-072-180	73	700-345-405	74
431-643-008	117	700-020-220	72	700-072-200	73	700-350-030	74
431-643-011	117	700-021-150	72	700-072-220	73	700-350-050	74
431-645-007	117	700-021-180	72	700-080-180	73	700-350-130	74
431-645-008	117	700-021-200	72	700-080-200	73	700-350-150	74
431-645-010	117	700-021-220	72	700-080-220	73	700-350-400	236
431-645-012	117	700-022-150	72	700-082-150	73	700-350-402	236, 237
431-645-016	117	700-022-180	72	700-082-180	73	700-350-405	236, 237
431-646-008	117	700-022-200	72	700-082-200	73	700-350-410	236
431-646-012	117	700-022-220	72	700-082-220	73	700-351-030	74
431-646-016	117	700-023-150	72	700-100-101	74	700-351-031	74
431-662-190	112	700-023-180	72	700-100-102	74	700-351-050	74
431-666-190	112	700-023-200	72	700-100-103	74	700-351-051	74
431-668-190	112	700-023-220	72	700-100-130	74	700-351-131	74
503-003-000	155	700-030-150	72	700-100-150	74	700-351-151	74
503-011-000	156	700-030-180	72	700-101-001	74	700-351-231	74
503-013-000	156	700-030-200	72	700-101-030	74	700-351-251	74
510-050-100	161	700-030-220	72	700-101-050	74	700-360-031	74

<u>Order number</u>	<u>Page</u>
700-360-051	74
700-361-030	74
700-361-050	74
700-362-030	74
700-362-050	74
700-363-030	74
700-363-050	74
700-364-030	74
700-370-030	74
700-370-050	74
700-500-300	74
700-500-500	74
700-501-300	74
700-501-303	74
700-501-500	74
700-501-503	74
700-503-000	236, 237
700-503-001	236, 237
700-503-003	236, 237

<u>Order number</u>	<u>Page</u>
---------------------	-------------

<u>Order number</u>	<u>Page</u>
---------------------	-------------

<u>Order number</u>	<u>Page</u>
---------------------	-------------

