

index.

diagnostische endoskopie.	4 - 41
arthroskopie.	42 - 83
laparoskopie.	84 - 113
geräte.	114 - 136





passion for animals.

SPITZ VetCare ist Ihr kompetenter Partner für die Endoskopie in der Tierarztpraxis/Klinik. Von der Laparoskopie über die Arthroskopie bis hin zur Diagnostik bieten wir Ihnen alles was Sie für den minimal-invasiven Zugang benötigen. Von Nadelhaltern über hochauflösende 4K-UHD-Kameras bis hin zu kundenspezifischen Sonderanfertigungen haben wir ein exklusives Produktportfolio, das auf Ihre Bedürfnisse eingeht.

Dr. med. vet. Markus Spies ist seit 20 Jahren in der Veterinärmedizin als Kliniker und in der Industrie tätig. SPITZ VetCare wurde 2021 als Tochterunternehmen des Tuttlinger Familienunternehmens RZ Medizintechnik GmbH gegründet.

Und darum geht es bei Spitz VetCare: Die klinische Erfahrung und Leidenschaft von Tierärzten kombiniert mit der Erfahrung in der Entwicklung und Herstellung von Medizintechnik machen Spitz VetCare zu einem starken Partner. Die Veterinärmedizin ist für uns nicht nur ein Nebenfach der Humanmedizin, sondern ein wichtiger Bestandteil der modernen Medizintechnik.





diagnostische endoskopie.





- Große Auswahl an flexiblen, semi-flexiblen und starren Instrumenten
- Spezielle Instrumente für die Rhinoskopie, Laryngoskopie, Otoskopie, Vaginoskopie und Zystoskopie
- Unterschiedliche Endoskope und Schäfte für alle Indikationen
- Für die Diagnose und Behandlung über die natürliche Körperöffnungen

Universelles und flexibles „Rundum-sorglos-System“ für Diagnostik und die endoskopische Therapie. Das Komplettsystem lässt sich leicht transportieren, intuitiv einrichten und nutzen. Der ultrahochauflösende Monitor und die FullHD-Kamera erzeugen ein hochwertiges Bild und die 60Watt äquivalente Lichtquelle sorgt für eine gute Ausleuchtung.

- 4K HD 17,3" Bildschirm
- LED-Lichtquelle, 60W äquivalent
- Desinfizierbare FullHD-Kamera mit Zoom-Adapter
- Endoskopische Plattform mit Video- und Bildrekorder und Netzwerkanschluss
- Auflösung: 1920 x 1080

300-490-001

ALL IN ONE FULL HD SYSTEM

bestehend aus:

- A Kamerakopf, Full HD
- B TV-Adapter, f1.4 bis f3.5
- C Lichtleiterkabel mit Adapter
- D Laptop mit Software, LED Lichtquelle
- E Koffer



Die mobile, endoskopische Untersuchung wird mit dieser HD Kamera möglich. Integrierte Beleuchtung und ein leistungsstarker Kamerakopf, der über USB 3.0 mit Strom versorgt wird, ermöglichen Untersuchungen und minimalinvasive Eingriffe.

- Full HD (1920 x 1080) Aufnahmefunktion (Bilder/Video)
- Kompatibel mit allen USB 3.0 ports
- Langlebige LED Lichtquelle
- Programmierbare Bedienknöpfe am Kamerakopf
- Lichthelligkeit über Kamerakopf anpassbar
- Einfache Softwareinstallation und Bedienung (Software inkl. Patientenmanagement/-speicherung)
- Plug & Play

300-001-480

FULL HD CAMERA SET

bestehend aus:

- A Kamerakopf
- B TV-Adapter
- C Lichtquelle
- D Koffer
- E Software (Laptop nicht inclusive)





Otoskop, 5 Charr. Arbeitskanal, \varnothing 4mm, 65mm Arbeitslänge
0° 410-005-000

Flexible Instrumente

- 280mm Arbeitslänge
- 5 Charr.

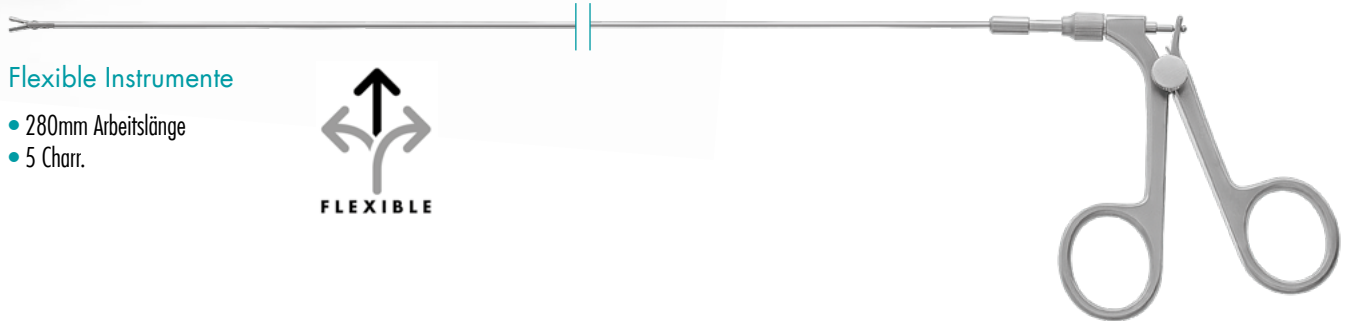

Stein Fasszange, doppelbeweglich
flexibel 253-202-005



Biopsiezange, doppelbeweglich
flexibel 253-204-005



LuerLock Adapter, drehbar
253-000-302



Durchflusshahn, LuerLock-Schlauchansatz
300-011-179



Durchflusshahn, LuerLock männlich
300-011-515

HNO
Otoskopie



Hartmann Ohrzange, gerade, gerieft

1 x 8mm

410-210-085



**Hartmann-Herzfeld Ohrzange, gerade,
87mm Arbeitslänge**

2.5mm spoon

410-338-136

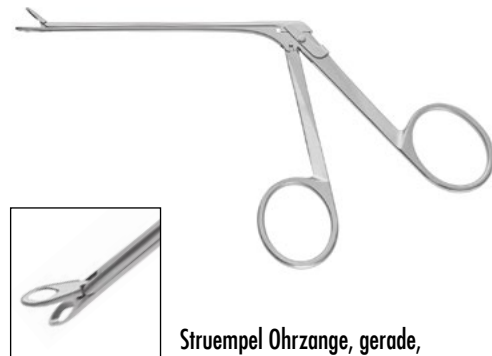

**Struempel Ohrzange, gerade,
87mm Arbeitslänge**

2.5 x 7.0mm

410-338-134

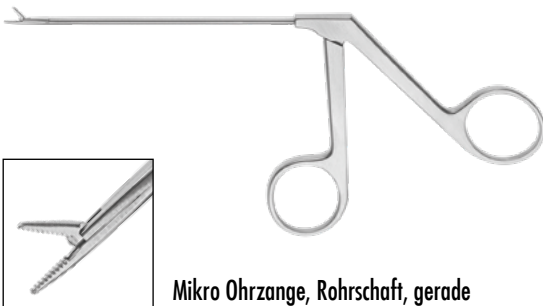

**Mikro Ohrzange, Rohrschaft, gerade
80mm Arbeitslänge**

0.8 x 3.5mm

410-330-000

Watteträger, spiralförmig, \varnothing 1.5mm

180mm

160-412-180

Farrell Watteträger, dreikant, \varnothing 0.9mm

120mm

160-426-120

140mm

160-426-140

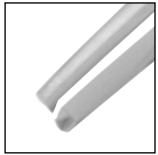

Troeltsch Gewebepinzette, 1 x 2 Zähne,
kniegebogen

125mm

410-377-120



House Kürette, scharf, doppelendig, ovale Löffel,
stark gebogen, 1.0 x 1.2mm

150mm

410-044-003



Williger Doppelkürette, oval/oval
#0 / 1 (Ø 3.0 / 3.5mm)

140mm

210-216-001



HNO

Rhino/Naso

Rhinoskopie / Nasopharyngeale Endoskopie

Instrumente und Zubehör zur Visualisierung des
nasopharyngealen Bereiches





Set für
HUNDE

Ø2.7mm



Sinuskop, Ø 2.7mm, 180mm Arbeitslänge

0°	252-127-000
30°	252-127-030
70°	252-127-070



Untersuchungs- und Arbeitsschaft für 30° Optiken,
mit abnehmbarem Griff, 3,8 x 5,6mm,
5 Charr. Kanal, 150mm Arbeitslänge

für Ø 2.7mm Endoskope 252-027-187

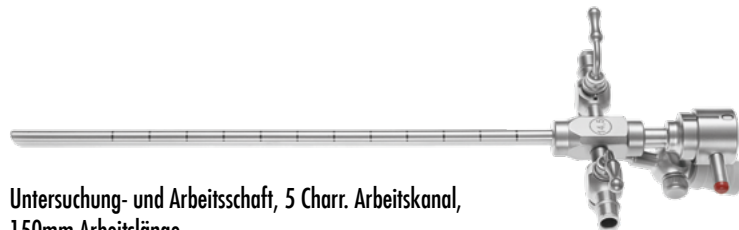

Untersuchung- und Arbeitsschaft, 5 Charr. Arbeitskanal,
150mm Arbeitslänge

für Ø 2.7mm Endoskope 252-027-185



Reinigungsbürste, flexibel, Ø 2.5mm,
120mm Länge, für 5Charr. Arbeitskanäle

253-961-102



FLEXIBLE

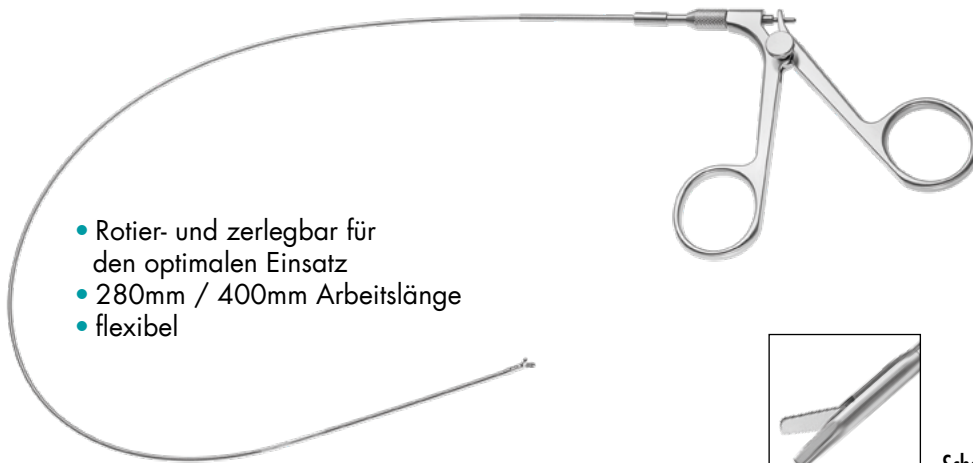

- Rotier- und zerlegbar für den optimalen Einsatz
- 280mm / 400mm Arbeitslänge
- flexibel



Fasszange, geriefes Maulteil, doppelbeweglich

400mm	351-114-105
280mm	253-202-005



Schere, einfach beweglich

400mm	351-100-105
280mm	253-203-005

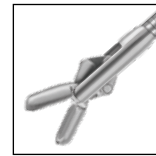

Biopsiezange, ovale Löffel, doppelbeweglich

400mm	351-120-105
280mm	253-204-005

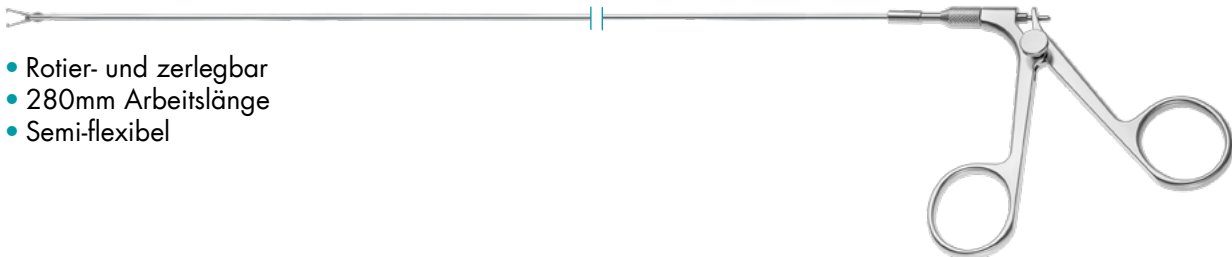

- Rotier- und zerlegbar
- 280mm Arbeitslänge
- Semi-flexibel

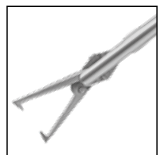

Große Steinfasszange, doppelbeweglich

5 Charr.	253-200-228
----------	-------------

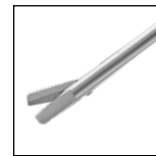

Schere, einfach beweglich

5 Charr.	253-200-428
----------	-------------

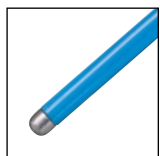

Ballelektrode, monopolar, 530mm Länge

5 Charr.	253-370-005
----------	-------------

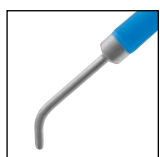

Nadelelektrode, monopolar, 530mm Länge

5 Charr.	253-371-005
----------	-------------

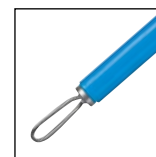

Schlingenelektrode, monopolar, 250mm Länge

5 Charr.	253-372-005
----------	-------------





Set für KATZEN

Ø2.0mm

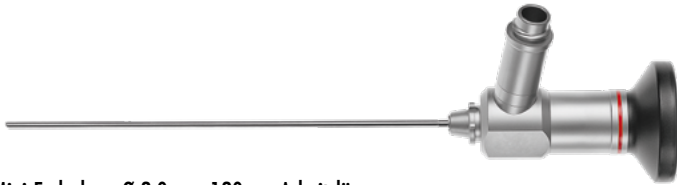

Mini-Endoskop, Ø 2.0mm, 120mm Arbeitslänge

0°	253-221-000
30°	253-221-030

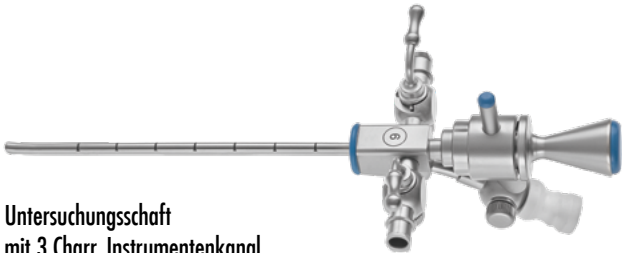

Untersuchungsschaft mit 3 Charr. Instrumentenkanal, atraumatische Spitze

9 Charr. / 3mm	253-200-009
----------------	-------------

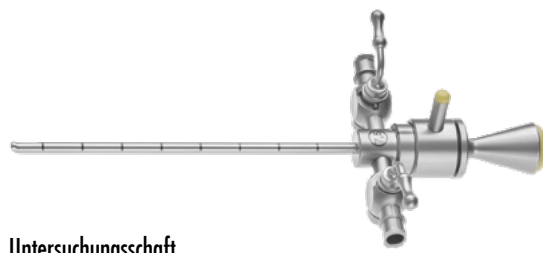

Untersuchungsschaft, atraumatische Spitze

7.5 Charr. / 2.5mm	253-200-007
--------------------	-------------



- Rotier- und zerlegbar für den optimalen Einsatz
- 280mm Arbeitslänge
- Flexibel



Alligator Fasszange, doppelbeweglich

flexibel	253-202-003
----------	-------------

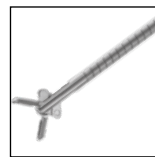

Biopsieforceps, doppelbeweglich

3 Charr.	253-204-003
----------	-------------

Schere, 3 Charr.

flexibel	253-203-003
----------	-------------

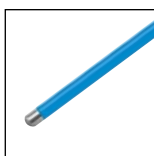

Ballelektrode, monopolar, 250mm Länge

3 Charr.	253-370-253
----------	-------------

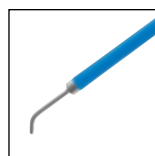

Nadelelektrode, monopolar, 250mm Länge

3 Charr.	253-371-253
----------	-------------





*Visualisierung
mit minimalem Aufwand*

Tragbare LED Lichtquelle, mit 1700mAh Ladegerät

300-001-183





Instrumente für die endoskopisch unterstützte oder offene Behandlung



Halle-Tieck Spekulum, Schraubgelenk,
130mm komplette Länge

17.5mm Blattlänge

420-140-135



DJ Zange, doppelbeweglich
400mm Arbeitslänge

7 Charr.



FLEXIBLE

351-107-107



DJ Zange, doppelbeweglich
400mm Arbeitslänge

7 Charr.



SEMI
FLEXIBLE

351-107-307



Blakesley Zange, 150mm Arbeitslänge

3.5mm

4.0mm

5.0mm

252-035-150

252-040-150

252-050-150

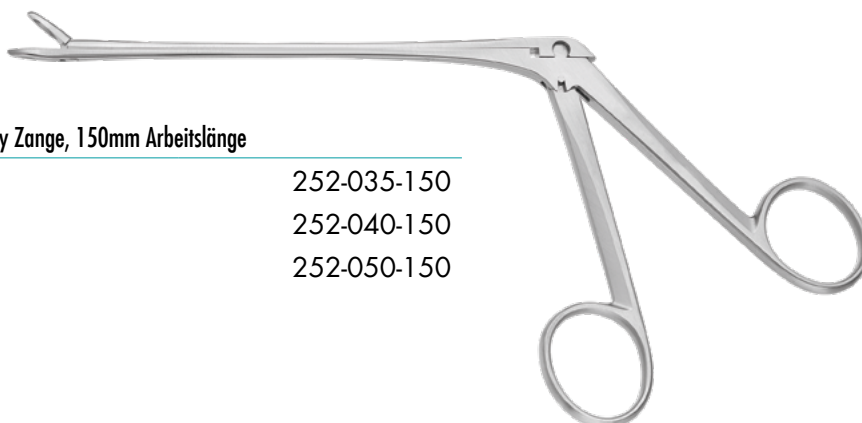



Noyes Zange, 115mm Arbeitslänge
 gefensterter Maulteil

252-527-115



Biopsie und Fasszange, feine Ausführung,
 140mm Arbeitslänge

3mm ovale Löffel

252-503-140

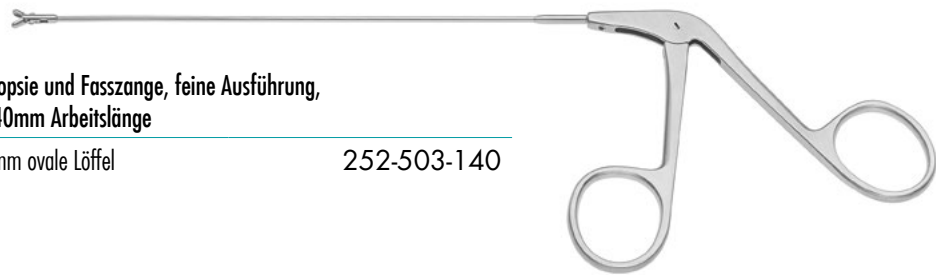

Struempel Zange mit
 ovalem, gefensterter Maulteil
 120mm Arbeitslänge

gerade

252-031-120



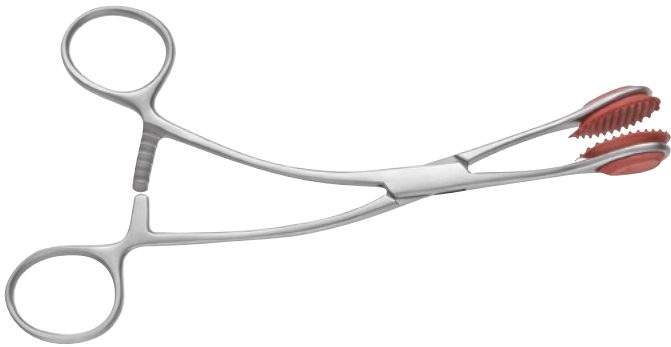

Young Zungenhaltezange

170mm

430-467-170



Hurd Elevator

230mm

430-522-230



Green Retraktor, 20 x 23mm

220mm

170-319-220



Lange Choana Haken

230mm

420-413-230



Laryngeal Spiegel mit hexagonalem Griff, 180mm

Fig. 00, Ø8mm	230-330-008
Fig. 1, Ø12mm	230-330-012
Fig. 3, Ø16mm	230-330-016
Fig. 5, Ø20mm	230-330-020



Biopsie Zange, vertikal greifend, 70° nach oben gebogen, 4 x 8mm, 130mm Arbeitslänge

70° nach oben gebogen	252-670-120
110° nach hinten gebogen	252-770-120

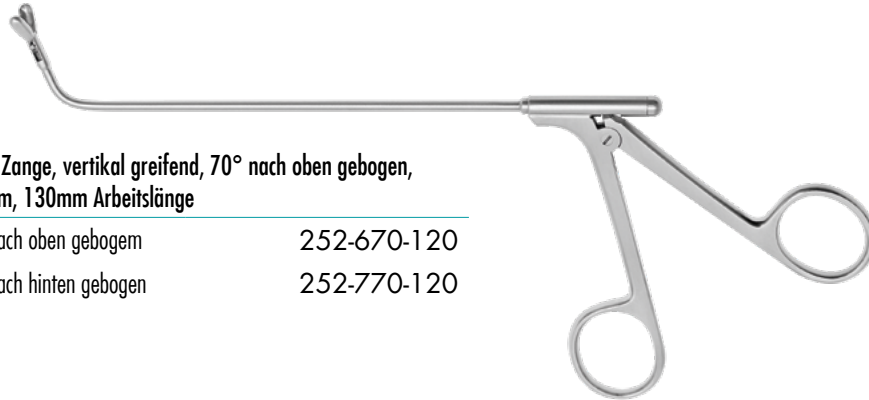

Bronchoskopie/ Oesophagus-/Gastroskopie

Instrumente und starre Endoskope für die
Atemwege und den Gastrointestinaltrakt



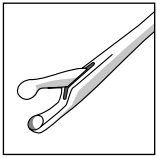

Löffelzange mit runden 2mm und 4mm Maulteil, konischer Rohrschaft, 230mm Arbeitslänge

gerade 100-700-001

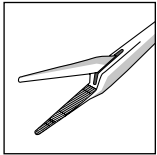

Alligatorzange, Standard Modell, konischer Rohrschaft, 2mm, 230mm Arbeitslänge

gerade, gerieft 100-700-020

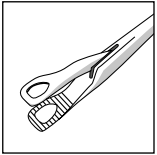

Alligatorzange, Standard Modell, konischer Rohrschaft, 2mm, dreieckiges Maulteil, 230mm Arbeitslänge

gerade 100-700-026

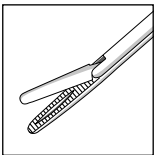
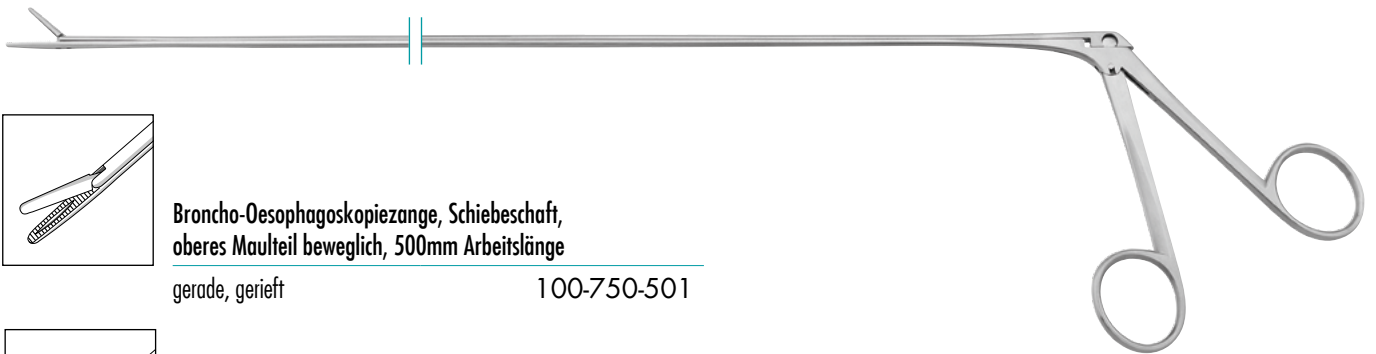

Broncho-Oesophagoskopiezange, Schiebeschäft, oberes Maulteil beweglich, 500mm Arbeitslänge

gerade, gerieft 100-750-501

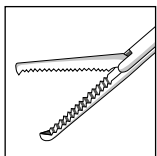

gerade, 1x2 gezahnt 100-750-502

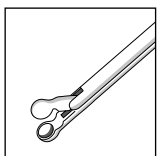

gerade, Löffel 100-750-504

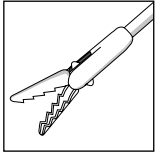
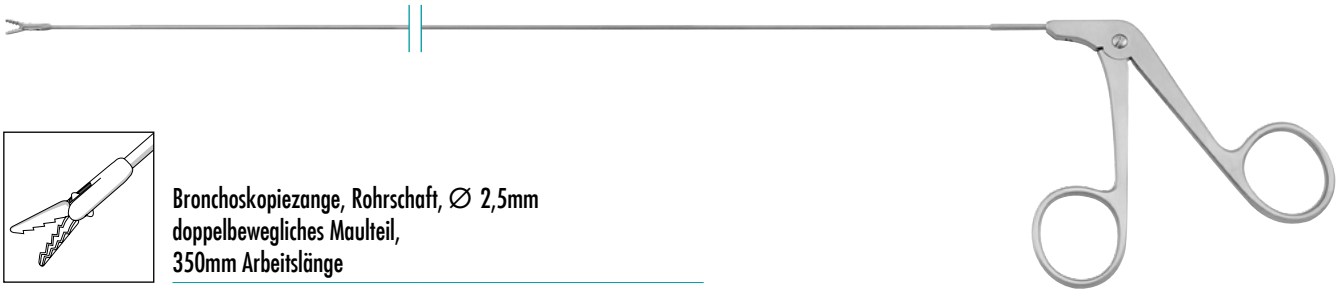

Bronchoskopiezange, Rohrschaft, \varnothing 2,5mm
doppelbewegliches Maulteil,
350mm Arbeitslänge

Alligator Maul

100-720-021

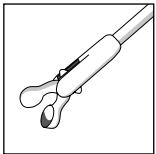

Bronchoskopiezange, Rohrschaft, \varnothing 2,5mm
doppelbewegliches Maulteil,
Biopsie Löffel, 350mm Arbeitslänge

gerade, Löffel

100-720-023

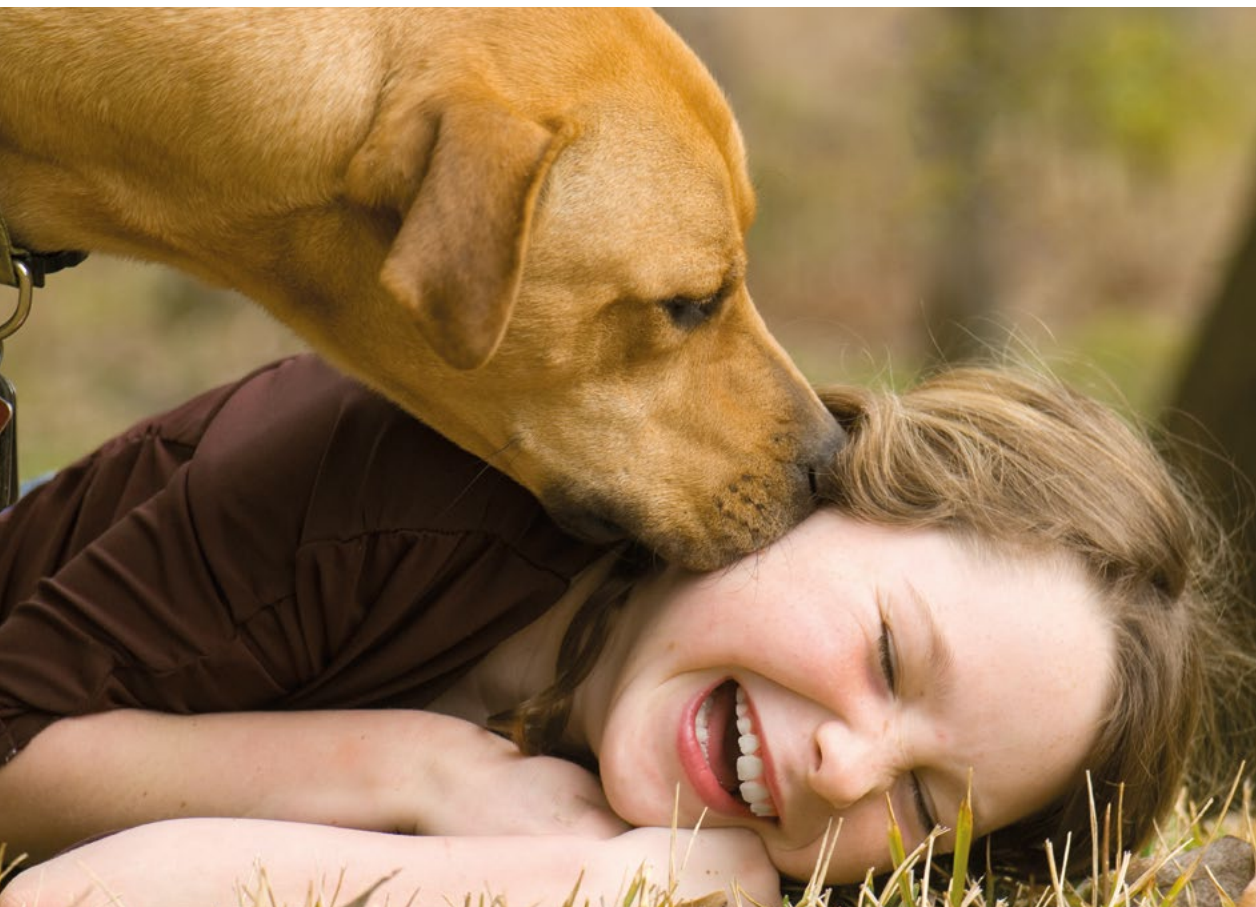



Bronchoskop, starr, 300mm Arbeitslänge, 0°
 Ø 2.9mm 100-629-000

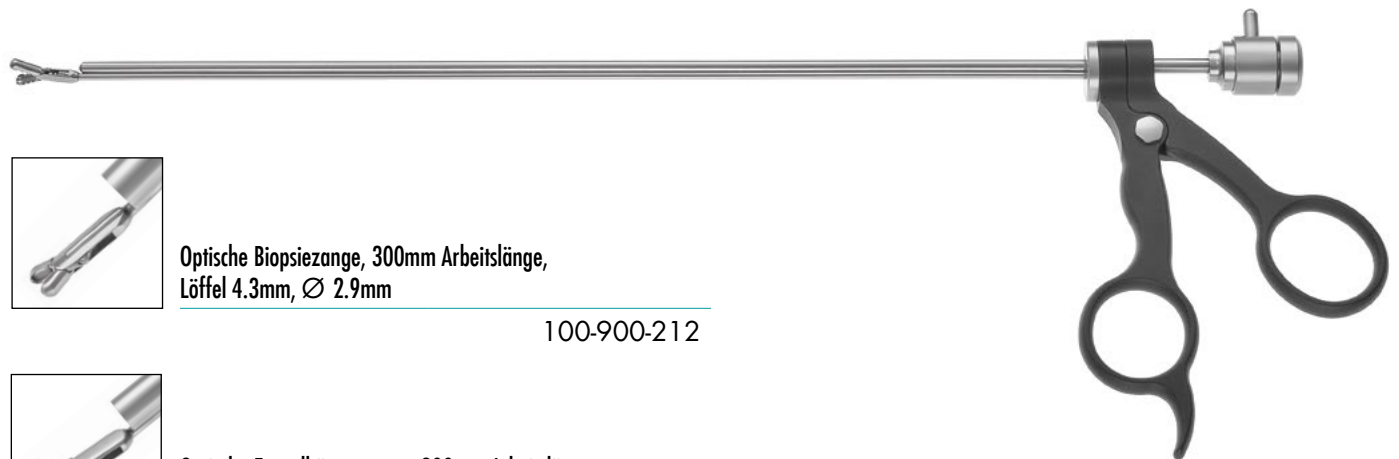

**Optische Biopsiezange, 300mm Arbeitslänge,
 Löffel 4.3mm, Ø 2.9mm**
100-900-212



**Optische Fremdkörperzange, 300mm Arbeitslänge,
 für Bronchoskop 100-629-000**
100-900-217



Saugrohr, 250mm Arbeitslänge
 Ø 2.5mm 100-860-025



Saugrohr, mit flexibler Gummispitze
 350mm 100-852-350
 500mm 100-852-500



VERSATIP Zerlegbare, 360° rotierbare Instrumente

- ▼ Abnehmbar - ein Griff für alle Einsätze
- ▼ Farbcodiert - die einfache Identifizierung der Spitze
- ▼ Zwei Griffe - selbsthaltend und Standard
- ▼ Die Kugelspitzentechnik ermöglicht eine einfache Verbindung der einzelnen Teile
- ▼ Sehr leichter Griff - der perfekte Sitz für Ihre Finger
- ▼ Einfache Reinigung - Spülanschluss für das gesamte Instrument
- ▼ 360° Drehung - nur mit der Fingerspitze
- ▼ Alle Teile können einzeln bestellt werden



PATENTED
10 2022 107 371.8



Farbcodierte Einsätze

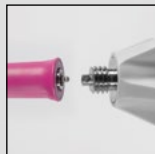

Einzigartiges,
zerlegbares System



Spülanschluss
zum einfachen Reinigen



Zwei Griffe -
viele Optionen

Zangen und Stanzen

- Selbsthaltend
- Schwarze Farbcodierung

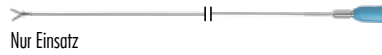

351-100-500
Selbsthaltender Griff für
Zangen und Stanzen
(empfohlener Griff)



Fasszange mit gezahntem Löffel,
starr, doppelbeweglich

Nur Einsatz 351-116-535
Komplettes Instrument 351-116-335



Tenaculumzange, 1x1 gezahnt,
halbstarr, doppelbeweglich

Nur Einsatz 351-117-535
Komplettes Instrument 351-117-335



SHARK Tenaculum Fasszange,
halbstarr, doppelbeweglich

Nur Einsatz 351-115-535
Komplettes Instrument 351-115-335

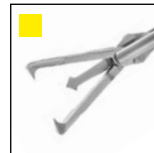

ACCARDI Harpoon Fasszange,
halbstarr, doppelbeweglich

Nur Einsatz 351-119-535
Komplettes Instrument 351-119-335



Biopsiezange,
starr, doppelbeweglich

Nur Einsatz 351-120-535
Komplettes Instrument 351-120-335



Biopsiestanze
starr, einfach beweglich

Nur Einsatz 351-126-535
Komplettes Instrument 351-126-335

Scheren

- Standardgriff
- Weiße Farbcodierung

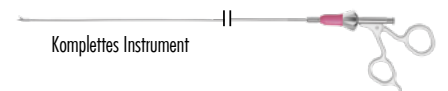

351-100-550
Standardgriff
für Scheren
(empfohlener Griff)



Schere, spitze Enden, einfach beweglich

Nur Einsatz 351-118-535
Komplettes Instrument 351-118-335

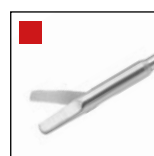

Schere, stumpfe Enden, starr, einfach beweglich

Nur Einsatz 351-100-535
Komplettes Instrument 351-100-335



Flexible Endoskopie

VIPER Video Endoskopiesystem & Gastroskop

- Plug & Play - ein Gerät für alle Optiken
- Helles LED Licht
- Bis zu 210° Abwinkelung
- 140° Weitwinkel



VIPER Video Endoskopiesystem



VIPER Endoskopiesystem
bestehend aus: Hauptgerät, Weißabgleichskappe,
USB Stick

310-800-300



Weißabgleichskappe
inklusive

Lieferung enthält:

- Hauptgerät
- Weißabgleichskappe
- USB Stick
- Netzkabel, Gebrauchsanweisung,
Sicherung

VIPER Gastroskop



Gastroskop

Arbeitslänge	Durchmesser	Arbeitskanal	
3500mm	12.8mm	3.7mm	310-800-301
1500mm	8.0mm	2.8mm	310-800-302
1000mm	6.0mm	2.0mm	310-800-303
Bronchoskop			
600mm	5.8mm	2.8mm	310-800-304
600mm	3.5mm	1.2mm	310-800-305

Lieferung enthält:

- Endoskop
- Spülflasche
- Druckmessgerät
- Reinigungsschlauch
- Reinigungszubehör
- Anschlusskabel
- Tragetasche
- Gebrauchsanweisung



Zubehör für flexible Endoskope



FLEXIBLE

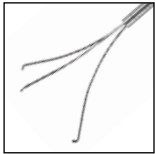

3-fach Greifer Fasszange 600mm Arbeitslänge

∅ 1.6mm	253-940-005
∅ 1.0mm	253-940-003



Fremdkörper-Fasszange, 2x2 Zähne

∅ 1.8mm, 2300mm Arbeitslänge	310-970-230
∅ 2.3mm, 2300mm Arbeitslänge	310-971-230

2x1 Zähne

∅ 2.3mm, 2300mm Arbeitslänge	310-973-230
∅ 1.8mm, 1800mm Arbeitslänge	310-972-180



3-fach Greifer Fremdkörper-Fasszange, rund

∅ 1.8mm, 1800mm Arbeitslänge	310-981-180
∅ 2.3mm, 1800mm Arbeitslänge	310-982-180
∅ 2.3mm, 2300mm Arbeitslänge	310-982-230



4-fach Greifer Fremdkörper-Fasszange, scharf

∅ 2.3mm, 2300mm Arbeitslänge	310-983-230
------------------------------	-------------





Biopsiezange, oval, gezahnt

∅ 1.0mm, 1200mm AL	310-935-100
∅ 1.8mm, 1200mm AL	310-935-120
∅ 1.8mm, 1800mm AL	310-935-180
∅ 2.3mm, 2300mm AL	310-937-230



Biopsiezange, oval, gefenstert

∅ 1.0mm, 1200mm AL	310-901-120
∅ 1.8mm, 1800mm AL	310-904-180
∅ 2.3mm, 2300mm AL	310-906-230



Biopsiezange, oval, fein gezahnt

∅ 1.8mm, 1800mm AL	310-944-180
∅ 2.3mm, 2300mm AL	310-945-230



Biopsiezange, oval, gefenstert, mit Nadel

∅ 1.8mm, 1600mm AL	310-907-160
∅ 2.3mm, 2300mm AL	310-909-230



Alligatorfasszange

∅ 1.0mm, 1200mm AL	310-960-120
∅ 1.6mm, 1600mm AL	310-962-160
∅ 1.8mm, 1800mm AL	310-963-180
∅ 2.3mm, 2300mm AL	310-964-230



Biopsiezange, rund, gefenstert

∅ 1.8mm, 2300mm AL	310-930-230
∅ 2.5mm, 1500mm AL	310-929-180



Rattenzahn, 2x1 Zähne

∅ 1.8mm, 1800mm AL	310-952-180
∅ 2.3mm, 2300mm AL	310-953-230

AL=Arbeitslänge

Zangen mit anderen Durchmessern und Längen sind auf Anfrage erhältlich

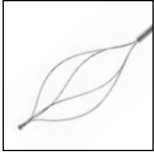

Dormia Metall-Steinfänger

7 Charr., 2.3mm / 2300mm AL	253-585-237
5 Charr., 1.6mm / 1800mm AL	253-585-185
5 Charr., 1.6mm / 600mm AL	253-585-005
3 Charr., 1.0mm / 600mm AL	253-585-003

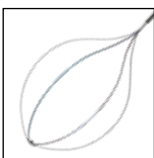
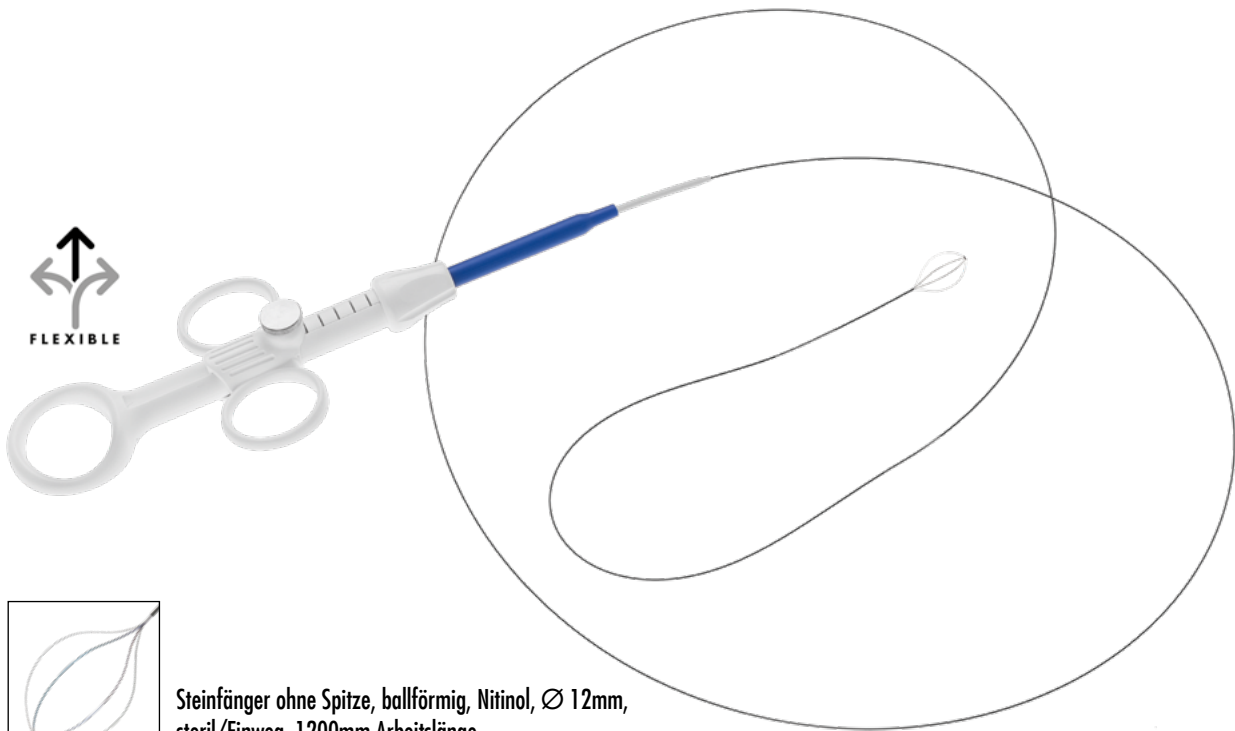

**Steinfänger ohne Spitze, ballförmig, Nitinol, Ø 12mm,
steril/Einweg, 1200mm Arbeitslänge**

1.3 Charr.	253-960-013
1.9 Charr.	253-960-019

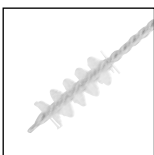

**Reinigungsbürste, 3.0 Charr., Einweg,
Packung mit 5 Stück**

3.0 Charr.	253-962-003
------------	-------------

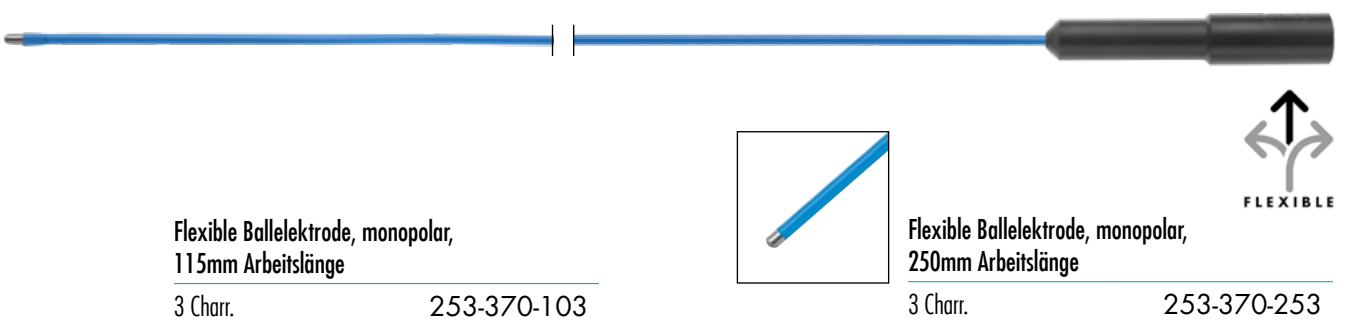
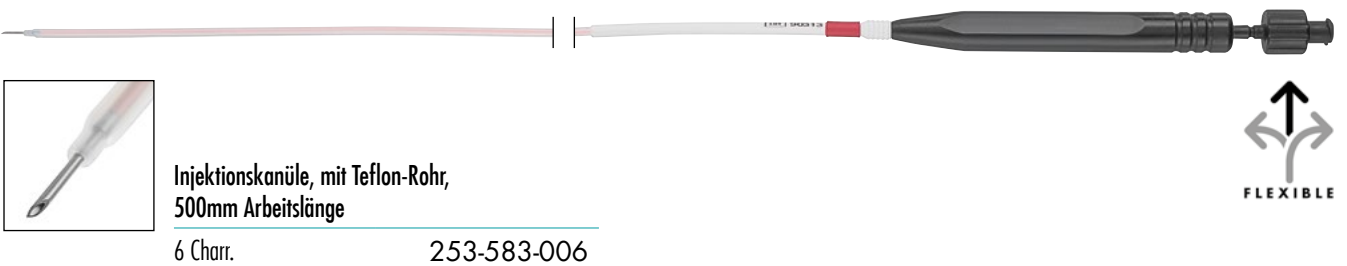
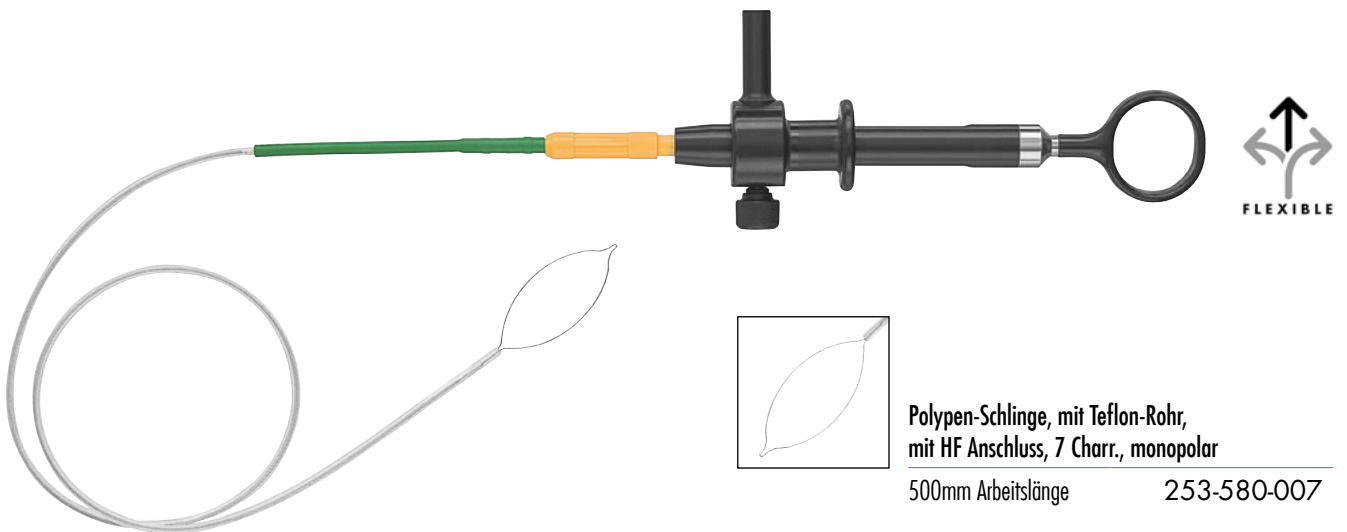
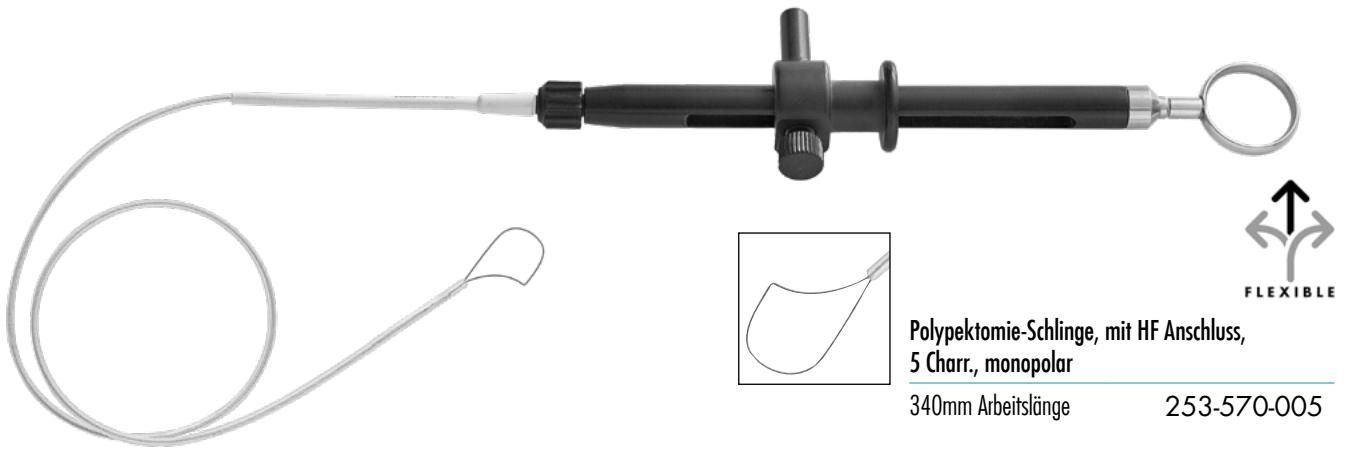

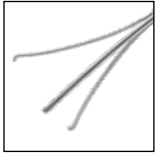

Steinfasszange, starr, 400mm Arbeitslänge,
dreifach gezahntes Maulteil, U-Feder Griff

5 Charr.

253-960-360



Steinfasszange mit Federgriff und Griffmulde,
Ø 4mm, Luer-Lock Anschluss
gefenstertes Maulteil

360mm

253-900-205

450mm

253-900-245



Steinfasszange mit Federgriff und Griffmulde,
Ø 4mm, Luer-Lock Anschluss
3-fach Greifarm

360mm

253-900-206

450mm

253-900-246

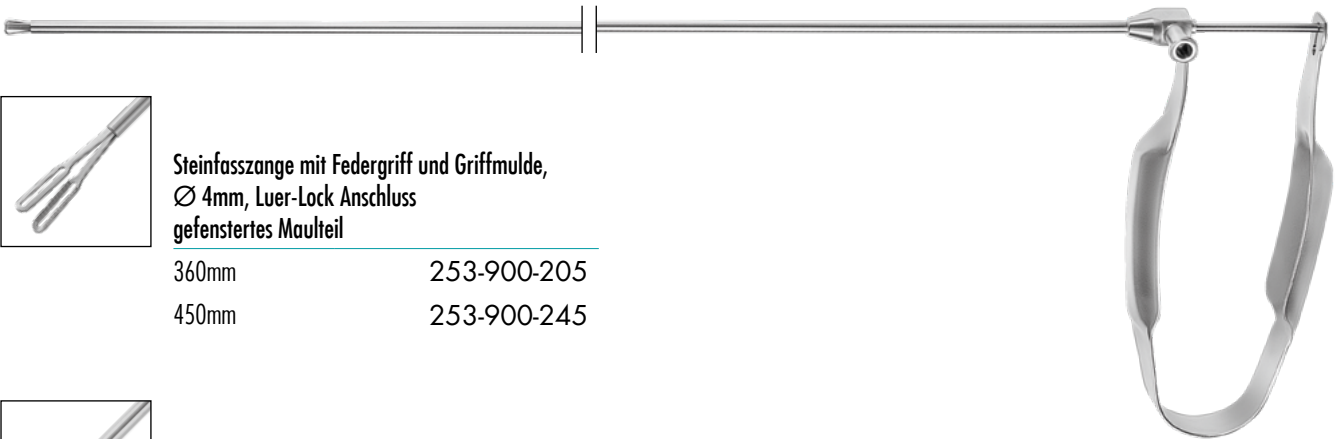
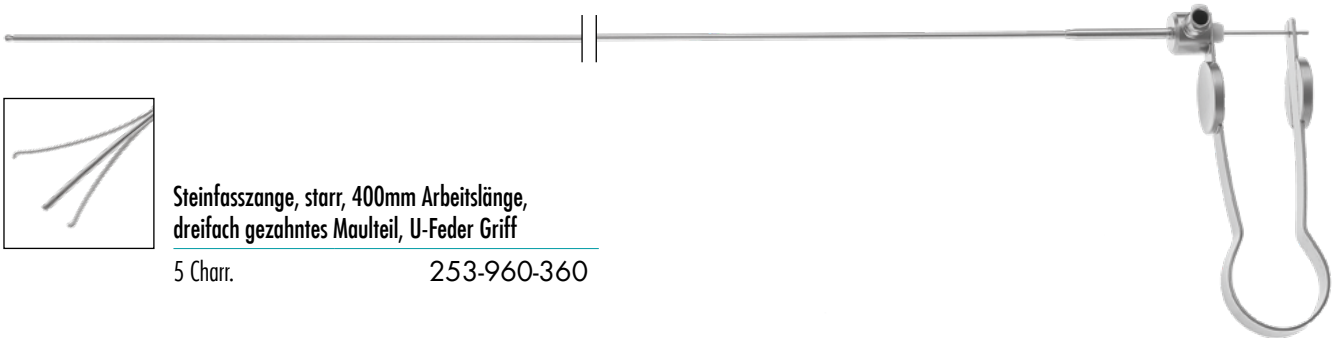

Urologie/Gynäkologie, Hysteroskopie





KLEIN

Ø2.0mm



Zystoskop, Ø 2.0mm, 120mm Arbeitslänge

0°	253-221-000
30°	253-221-030

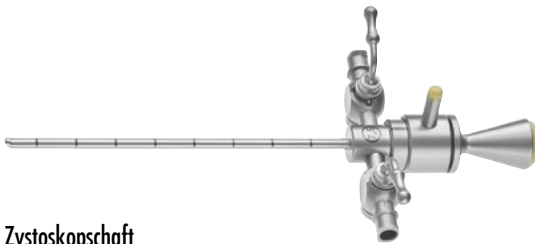

Zystoskopschaft

7.5 Charr.	253-200-007
------------	-------------

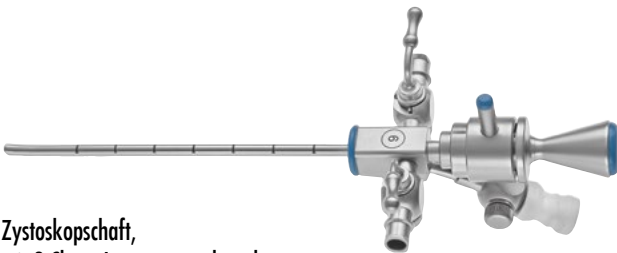

Zystoskopschaft,
mit 3 Charr. Instrumentenkanal

9 Charr.	253-200-009
----------	-------------



GROß

Ø2.7mm



Zystoskop, Ø 2.7mm, 187mm Arbeitslänge

0°	253-227-000
30°	253-227-030

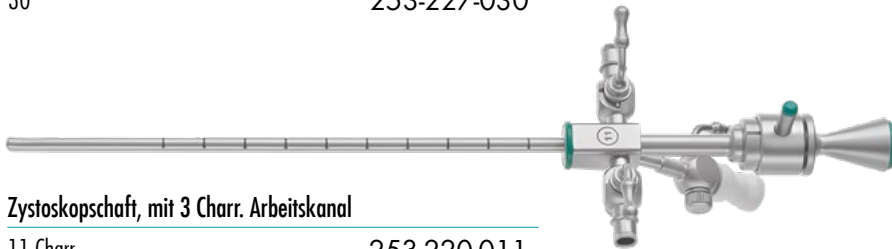

Zystoskopschaft, mit 3 Charr. Arbeitskanal

11 Charr.	253-220-011
-----------	-------------

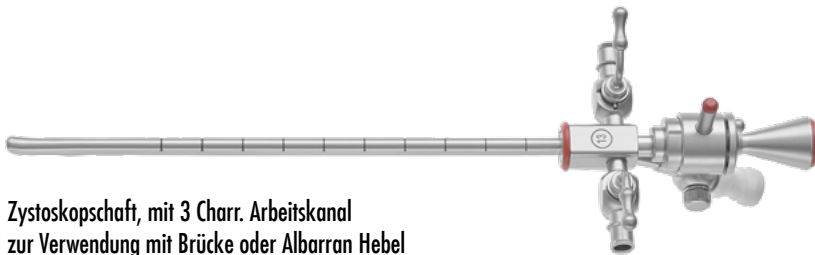

Zystoskopschaft, mit 3 Charr. Arbeitskanal
zur Verwendung mit Brücke oder Albarran Hebel

13 Charr.	253-220-014
-----------	-------------

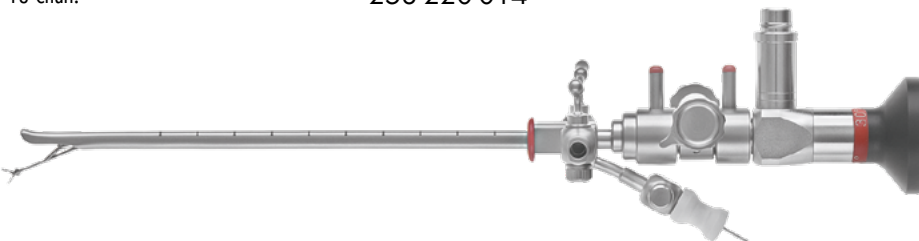

Albarran Hebel

für 253-220-014	253-220-025
für 3 Charr. Instrumente	253-202-003 + 253-204-003



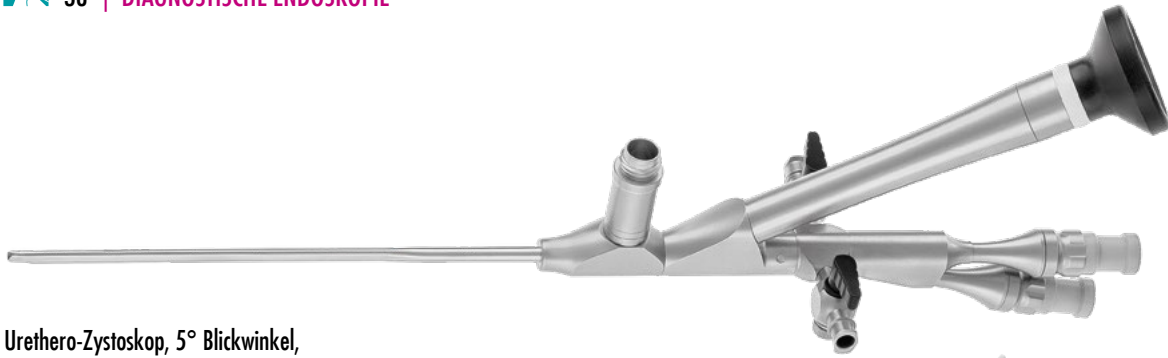

**Urethero-Zystoskop, 5° Blickwinkel,
2 seitliche Saug-/Spül-Anschlüsse, 140mm Arbeitslänge**

6.0 Charr. / 5.0 Charr. Arbeitskanal 253-200-600

4.5 Charr. / 3.5 Charr. Arbeitskanal 253-200-500



Silikonvalve

Packung
mit 5 Stück

253-905-400



Sinuskop, Ø 2.7mm, 180mm Arbeitslänge

30° 252-127-030

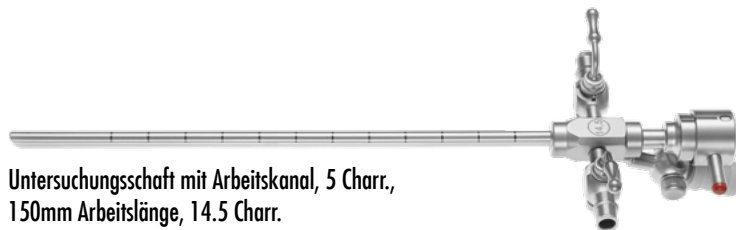

**Untersuchungsschaft mit Arbeitskanal, 5 Charr.,
150mm Arbeitslänge, 14.5 Charr.**

für 30° Endoskop 252-027-185

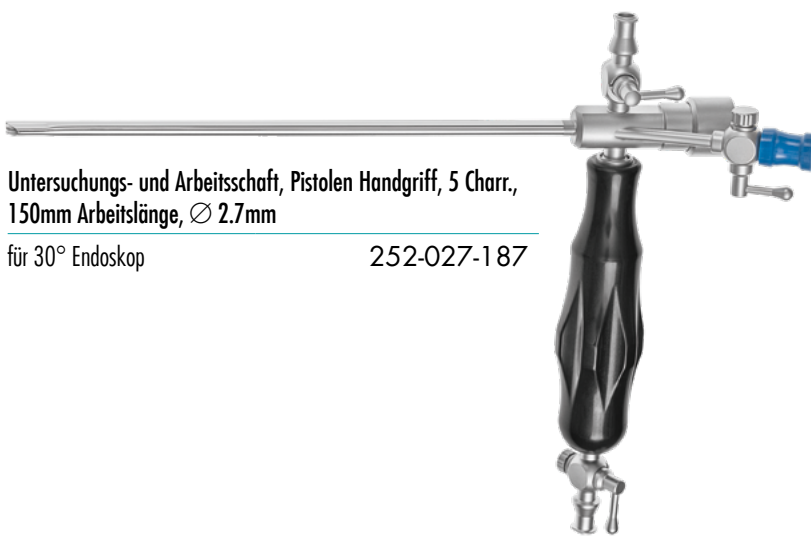

**Untersuchungs- und Arbeitsschaft, Pistolen Handgriff, 5 Charr.,
150mm Arbeitslänge, Ø 2.7mm**

für 30° Endoskop 252-027-187

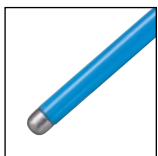

Ballelektrode, monopolar, 530mm Länge

5 Charr. 253-370-005

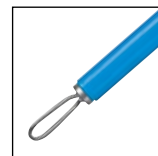

Schlingenelektrode, monopolar, 530mm Länge

5 Charr. 253-372-005





Killian Spekulum, 145mm

36 x 7mm	420-145-036
75 x 7mm	420-145-075



Cottle Spekulum, mit Feststellschraube, 135mm

38mm	420-136-035
70mm	420-136-070



St. Clair Thompson Spekulum, 73mm

38mm	420-052-001
65mm	420-002-003



Künstliche Besamung



Halbstarres Uretero-Renoskop

425mm Arbeitslänge

253-905-540

Distale Spitze	7.0 Charr.
Distal	8.0 Charr.
Proximal	9.5 Charr.
Arbeitskanal <small>(Für Instrumente bis 5 Charr.)</small>	5.8 Charr.
Blickwinkel	65°
Richtungswinkel	5°

slim LINE



Halbstarres Uretero-Renoskop

425mm Arbeitslänge

253-910-540

Distale Spitze	6.0 Charr.
Distal	7.0 Charr.
Proximal	7.5 Charr.
Arbeitskanal <small>(Für Instrumente bis 4 Charr.)</small>	5.0 Charr.
Blickwinkel	65°
Richtungswinkel	5°

Transurethrale Injektion



Zystoskop, Ø 4.0mm, 300mm Arbeitslänge
12° 253-804-012



Passives Titan Arbeitselement
für 253-804-012 253-000-312

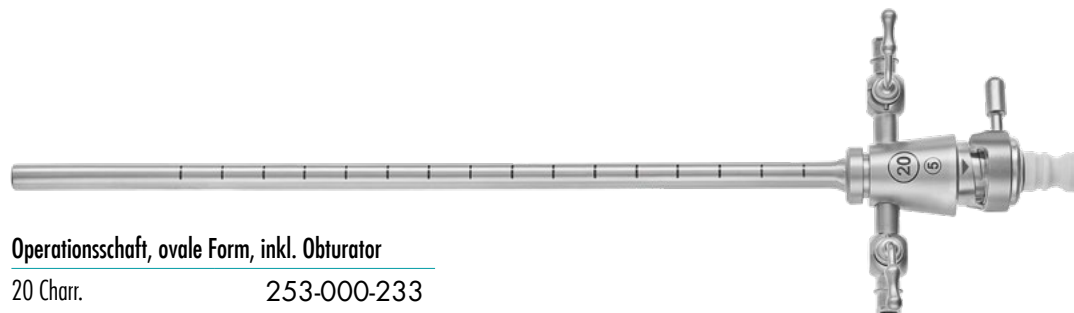

Operationsschaft, ovale Form, inkl. Obturator
20 Charr. 253-000-233



Injektionskanüle, halbstarr, 2 Charr. distales Ende mit rotierbarem Luer-Lock Adapter
4 Charr. 253-000-235



Exoten

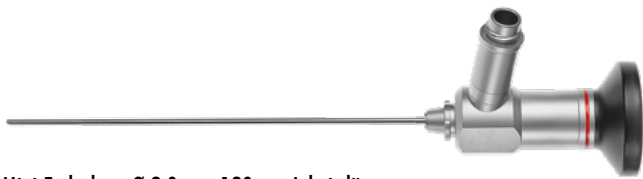
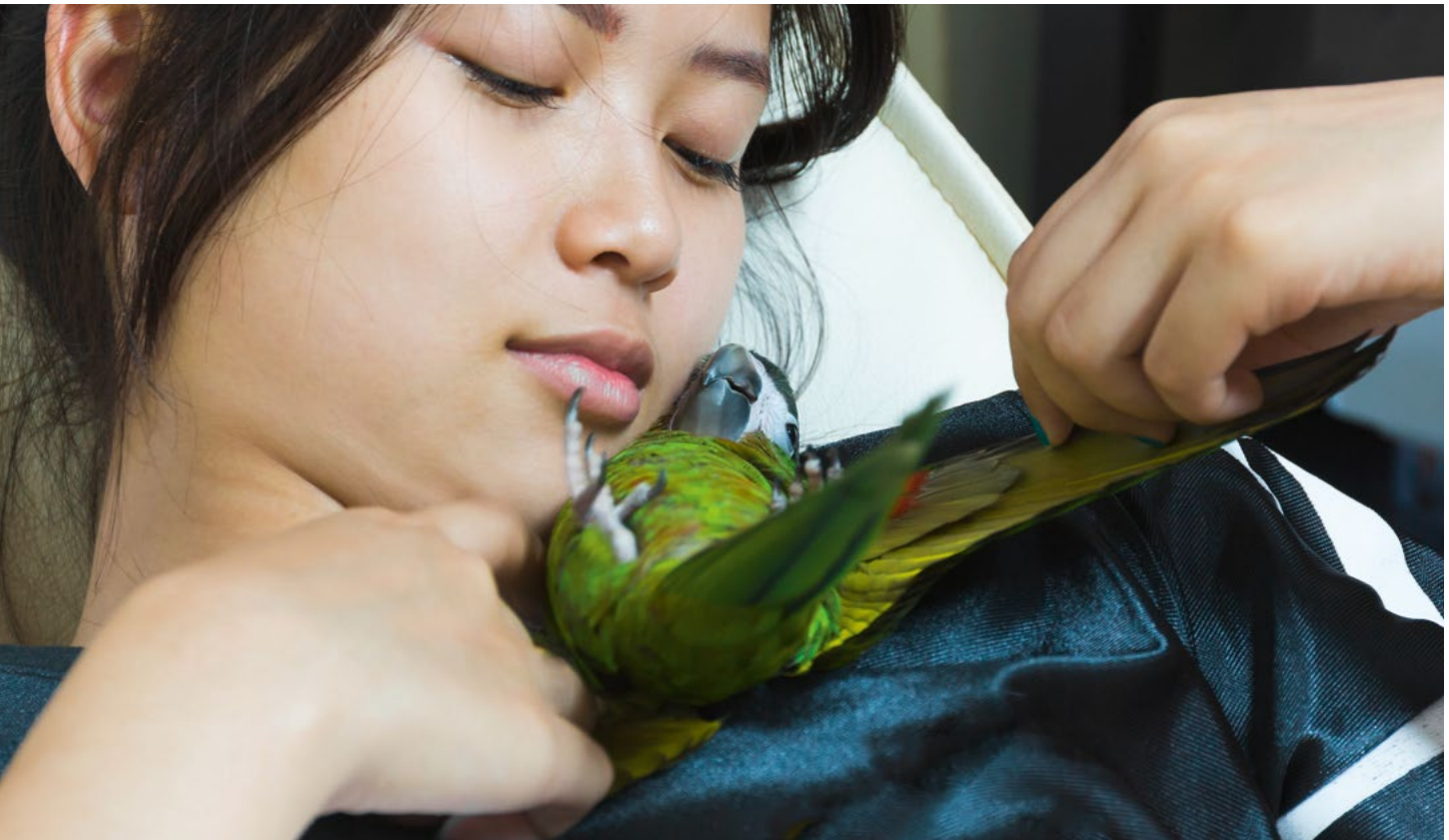

Mini-Endoskop, Ø 2.0mm, 120mm Arbeitslänge

- 0° 253-221-000
- 30° 253-221-030



Tragbare LED Lichtquelle, mit 1700mAh Ladegerät

300-001-183

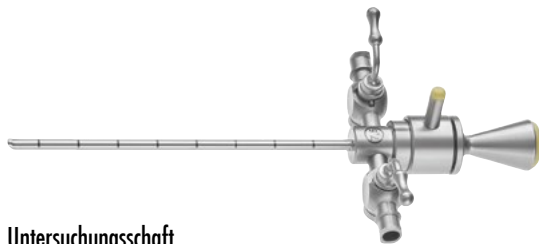

Untersuchungsschaft

- 7.5 Charr. 253-200-007

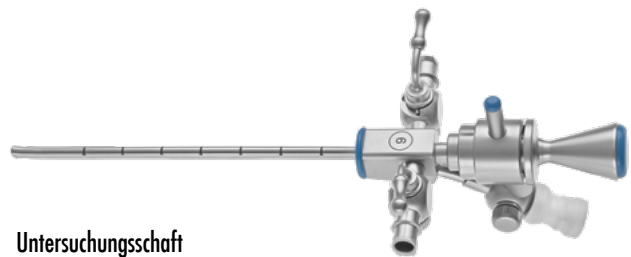

Untersuchungsschaft mit 3 Charr. Instrumentenkanal

- 9 Charr. 253-200-009



Mini-Endoskop, Ø 2.0mm, 187.5mm Arbeitslänge

0°	253-219-100
30°	253-219-130



Untersuchungsschaft

7.5 Charr.	253-200-075
------------	-------------

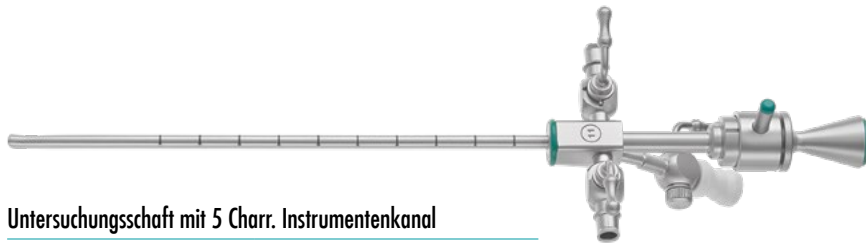

Untersuchungsschaft mit 5 Charr. Instrumentenkanal

11 Charr.	253-200-011
-----------	-------------



Sinuskop, Ø 2.7mm, 180mm Arbeitslänge

0°	252-127-000
30°	252-127-030
70°	252-127-070

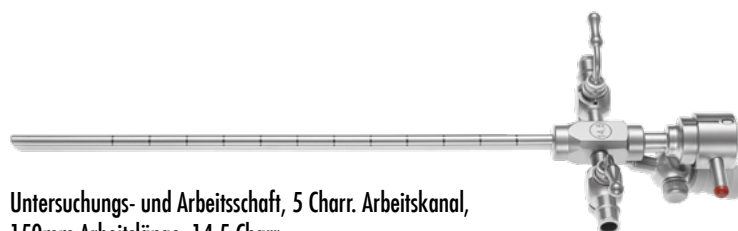

**Untersuchungs- und Arbeitsschaft, 5 Charr. Arbeitskanal,
150mm Arbeitslänge, 14.5 Charr.**

für Ø 2.7mm Endoskope	252-027-185
-----------------------	-------------

arthroskopie.





ArthVIEW®

- Full HD Endoskope für ein optimales Bild
- Farbcodierung kennzeichnet die Blickrichtung
- Hochbeständiges Saphirglas an der Spitze
- Optimierte Glasfaserbündel für gleichbleibende Helligkeit
- Komplett autoklavierbar



ArthFLOW®

- Perfekt passend für ArthVIEW® Endoskope
- 360° rotierbare Spülhähne
- Farbcodiert
- Einfach zu reinigen und zu pflegen
- Erhältlich als „regular“ und „highflow“





Arthroskopie Set nach Dr. Scharvogel

Diplomate ECVS

225-999-001

Arthroskopie Set nach

Dr. Stefan Scharvogel

Diplomate ECVS

Fachtierarzt für Chirurgie und Kleintiere

Die Arthroskopie ist zum Standard für die Diagnose und Behandlung von Gelenkerkrankungen in der Kleintierchirurgie geworden. Moderne Visualisierungstechniken und passende Instrumente machen anatomische Strukturen sichtbar. Pathologien können minimal-invasiv behandelt werden und führen zu einer schnelleren Rekonvaleszenz.

Dieses Arthroskopie-Set wurde von Dr. Stefan Scharvogel konfiguriert und basiert auf seiner Erfahrung und langjährigem Wissen als Tierarzt.

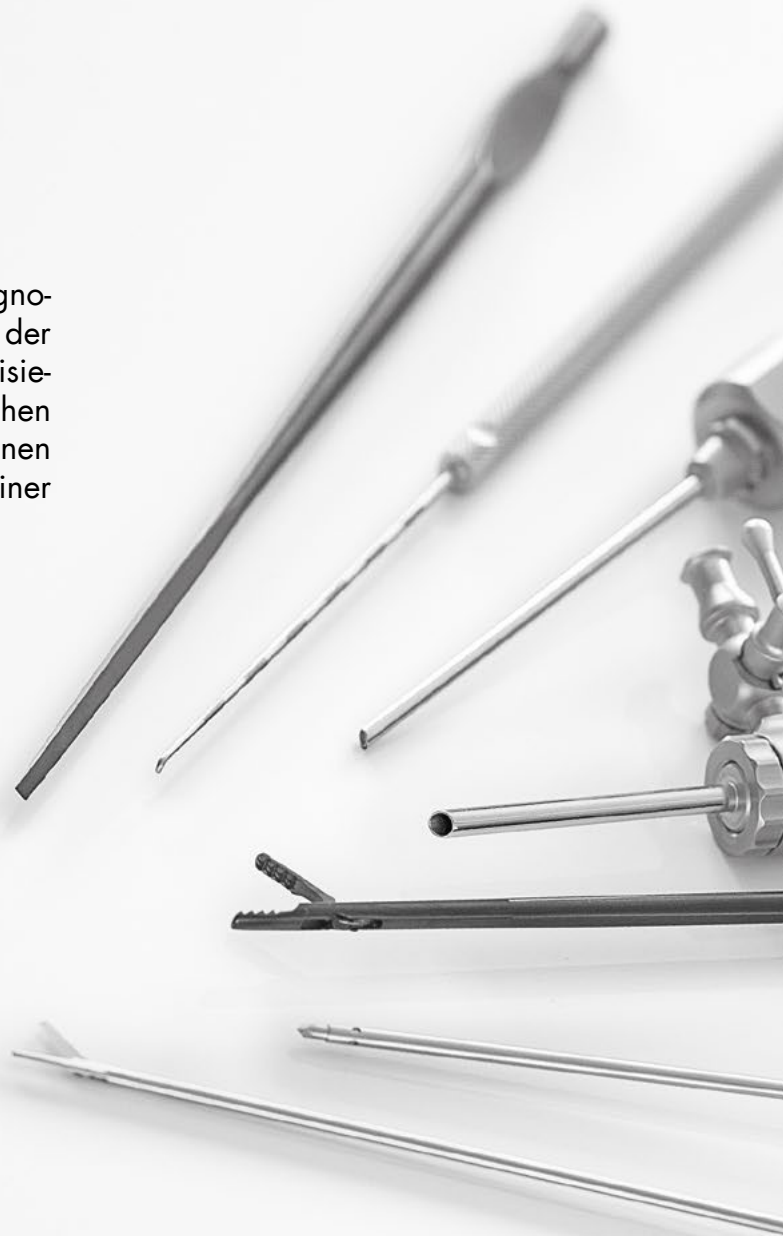





Arthroskopie Set nach Dr. Scharvogel

Diplomate ECVS

225-999-001

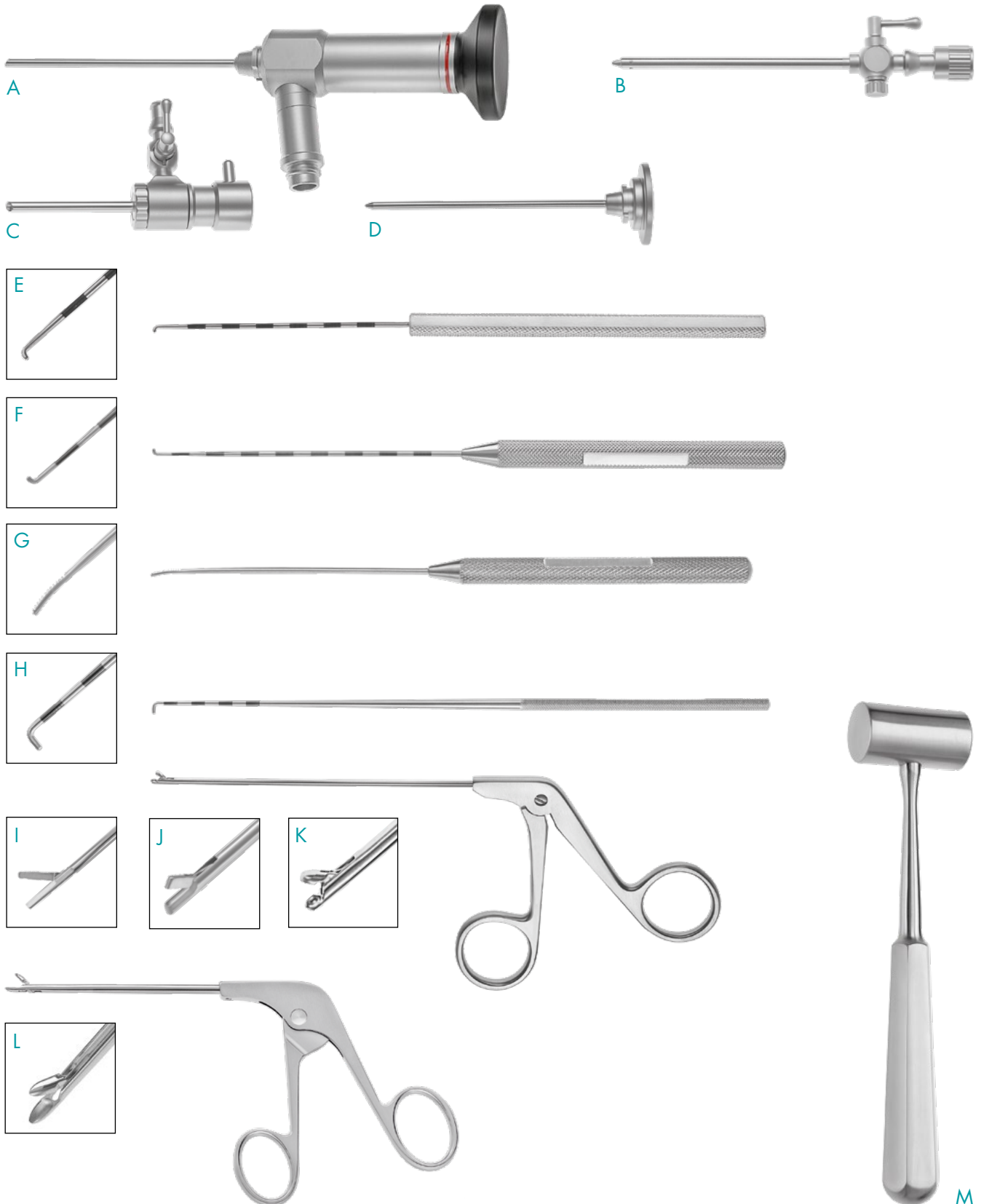



A	ArthView® Mini Arthroskop, Ø 2.4mm, 69mm Arbeitslänge	225-124-030
B	Spülkanülenset inkl. Trokar und Obturator, 70mm, Ø 2.3mm	225-850-000
C	ArthFlow® Schaft	225-512-332
D	ArthFlow® Obturator, für Ø 3.2mm Operationsschaft	225-512-532
E	Hakensonde, graduert, 75mm Arbeitslänge	225-100-115
F	Tasthaken, 4mm, graduert	225-090-002
G	Mini Raspel, konkaves Maulteil, 90mm Arbeitslänge	225-090-004
H	Tasthaken, 90° gewinkelt, Spitze Ø 1.0 mm, graduert, 130mm Arbeitslänge	225-100-004
I	Mini Schere, aufwärts schneidend, Ø 2.0mm, 130mm Arbeitslänge	225-310-020
J	Mini Stanze, Ø 2.0mm, 130mm Arbeitslänge	225-305-020
K	Mini Löffelzange, Ø 2.0mm, 130mm Arbeitslänge	225-307-020
L	ArthVANCE® Mini Rongeur, gerades Maulteil, gerader Schaft, 95mm Arbeitslänge	225-810-930
M	Partsch Hammer, 120g, Ø 22mm	210-225-180
N	Hakenmesser, 90° gewinkelt, 4mm, 130mm Arbeitslänge, schwarz	225-100-038B
O	Walter Osteotom, 2mm, 190mm Arbeitslänge, schwarz	420-580-002B
P	ArthVANCE® Alligator Faszszange, 2.7mm gerades Maulteil, slide lock Griff, schwarz	225-800-825
Q	ArthVANCE® Mini Faszszange, gerades Maulteil und Schaft, slide lock Griff, 85mm Arbeitslänge, schwarz	225-810-825



Arthroskopie Set nach Dr. Scharvogel

Diplomate ECVS

Geräteempfehlung



Q	P1 Arthroskopie Pumpe	225-906-000V
R	Stunner S1 Shaver System mit Handstück	227-001-101V + 227-001-102V
S	F2 FullHD Kamera System	300-001-601V
T	LUMEN LED1 Lichtquelle	300-900-180V



Q



R



S



T



Blax Instrumente

Der nächste Schritt in Richtung Perfektion.
Mit den Blax Instrumenten erleben Sie neue
Dimensionen der Schnittschärfe und Zuverlässigkeit.

- Höherer Korrosionswiderstand
- Länger anhaltende Schärfe
- Weniger Lichtreflektionen
- Hoher Verschleißwiderstand





Hakenmesser, 90° gewinkelt, 130mm Arbeitslänge

4mm 225-100-038B



Walter Osteotom, 190mm Arbeitslänge

2mm 420-580-002B



ArthVANCE® Alligator Fassungze,
slide lock Griff

2.7mm gerades Maulteil 225-800-825B



ArthVANCE® Mini Fassungze,
slide lock Griff, 85mm Arbeitslänge

gerades Maulteil / Schaft 225-810-825B



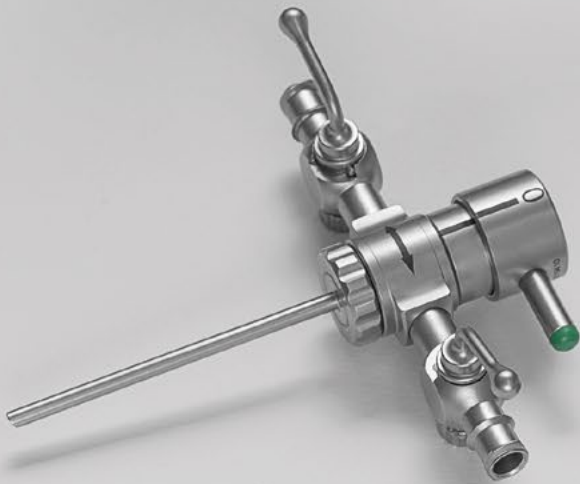

Mini Gelenke

Ø 1.9mm

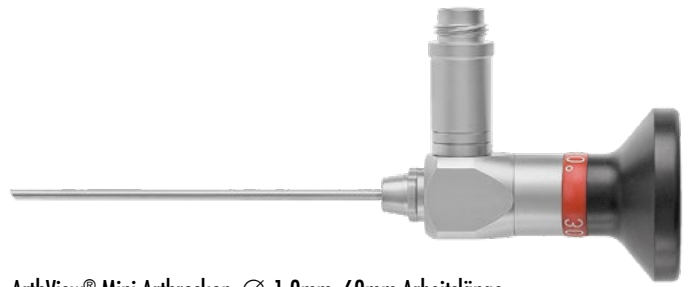

ArthView® Mini Arthroskop, Ø 1.9mm, 69mm Arbeitslänge

0°	225-019-000
30°	225-019-030

102mm Arbeitslänge

30°	225-019-130
-----	-------------



ArthFlow® Mini Obturator / Trokar,
für Ø 2.5mm Operationsschaft, grüne Farbcodierung
69mm Arbeitslänge

stumpf	225-511-525
scharf	225-511-625

für Ø 2.8mm Operationsschaft, blaue Farbcodierung
102mm Arbeitslänge

stumpf	225-510-528
scharf	225-510-628

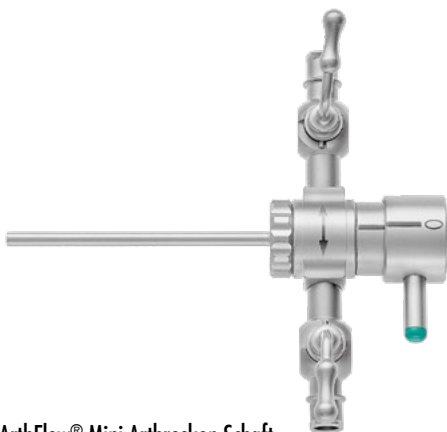

ArthFlow® Mini Arthroskop Schaft
2 Hähne, Ø 2.5mm, grüne Farbcodierung,
69mm Arbeitslänge

für 225-019-030 (30°)	225-512-225
für 225-019-000 (0°)	225-511-225

Ø 2.8mm, 102mm Arbeitslänge, blaue Farbcodierung

für 225-019-130 (30°)	225-510-428
-----------------------	-------------

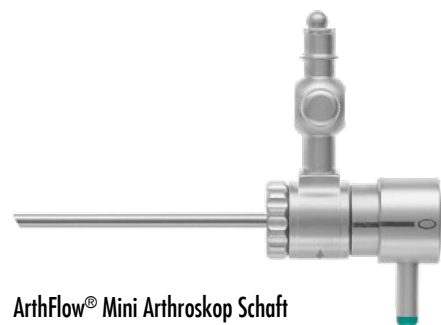

ArthFlow® Mini Arthroskop Schaft
1 Hahn, Ø 2.5mm, grüne Farbcodierung

für 225-019-030 (30°)	225-512-125
für 225-019-000 (0°)	225-511-125

Ø 2.8mm, 102mm Arbeitslänge, blaue Farbcodierung

für 225-019-130 (30°)	225-510-328
-----------------------	-------------



Klein Gelenke

Ø2.4mm

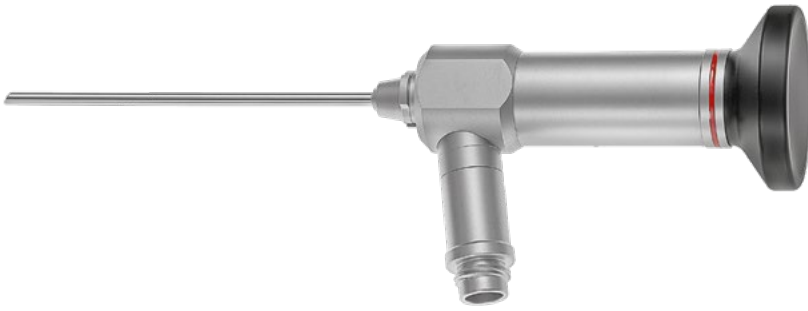

ArthView® Mini Arthroskop, Ø 2.4mm, 69mm Arbeitslänge

30° 225-124-030

0° 225-124-000

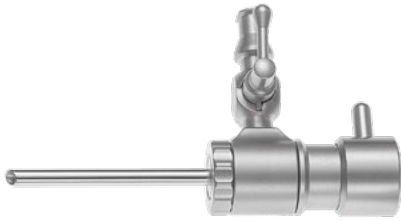

ArthFlow® Arthroskop Schaft, 1 Hahn, Ø 3.2mm

für 225-124-030 (30°) 225-512-332

für 225-124-000 / universal 225-512-232



ArthFlow® Obturator / Trokar, für Ø 3.2mm Operationsschaft

stumpf, für 225-512-332 225-512-532

scharf, für 225-512-332 225-512-632



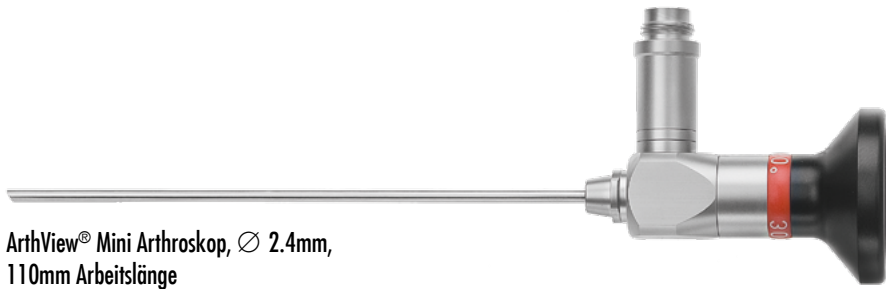

**ArthView® Mini Arthroskop, Ø 2.4mm,
110mm Arbeitslänge**

30°	225-224-030
0°	225-224-000
70°	225-224-070

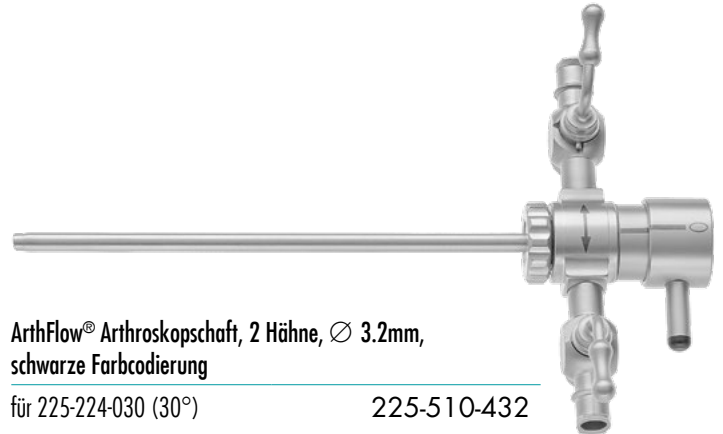

**ArthFlow® Arthroskopschaft, 2 Hähne, Ø 3.2mm,
schwarze Farbcodierung**

für 225-224-030 (30°)	225-510-432
für 225-224-000 (0° + 70°)	225-510-232

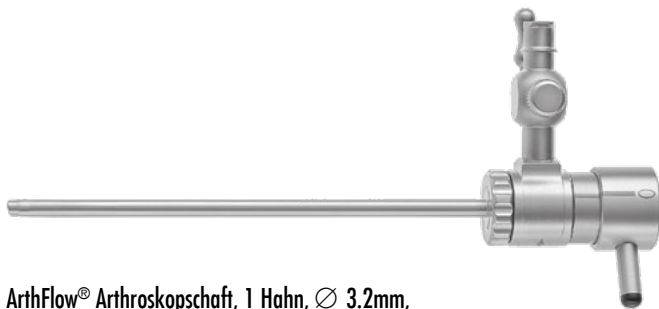

**ArthFlow® Arthroskopschaft, 1 Hahn, Ø 3.2mm,
schwarze Farbcodierung**

für 225-224-030 (30°)	225-510-332
für 225-224-000 (0° + 70°)	225-510-132



**ArthFlow® Mini Obturator / Trokar,
für Ø 3.2mm Operationsschaft, schwarze Farbcodierung**

stumpf	225-510-532
scharf	225-510-632



Klein Gelenke

Ø2.7mm

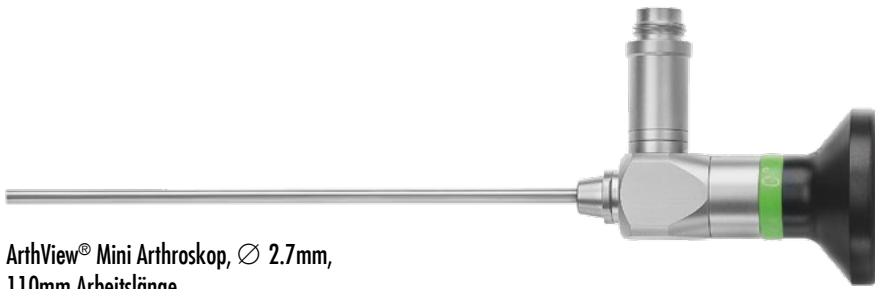

**ArthView® Mini Arthroskop, Ø 2.7mm,
110mm Arbeitslänge**

0°	225-227-000
30°	225-227-030
70°	225-227-070



**ArthFlow® Mini Arthroskopschaft,
2 Hähne, Ø 3.4mm, weiße Farbcodierung**

für 225-227-030 (30°)	225-500-434
für 225-227-000 (0° + 70°)	225-500-234

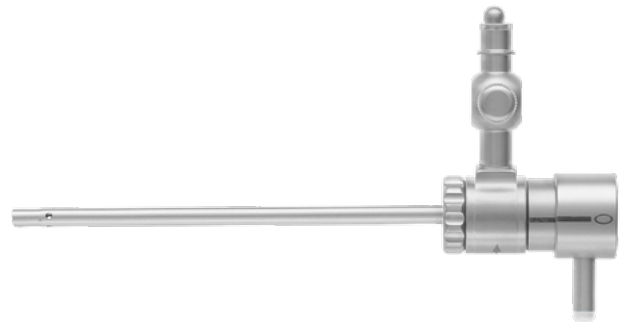

**ArthFlow® Mini Arthroskopschaft
1 Hahn, Ø 3.4mm, weiße Farbcodierung**

für 225-227-030 (30°)	225-500-334
für 225-227-000 (0° + 70°)	225-500-134



**ArthFlow® Mini Obturator / Trokar,
für Ø 3.4mm Operationsschaft, weiße Farbcodierung**

stumpf	225-500-534
scharf	225-500-634



Groß Gelenke

Ø 4.0mm

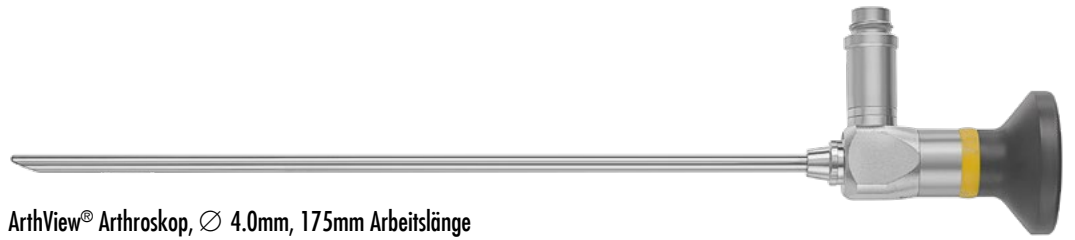

ArthView® Arthroskop, Ø 4.0mm, 175mm Arbeitslänge

0°	225-140-000
30°	225-140-030
45°	225-140-045
70°	225-140-070

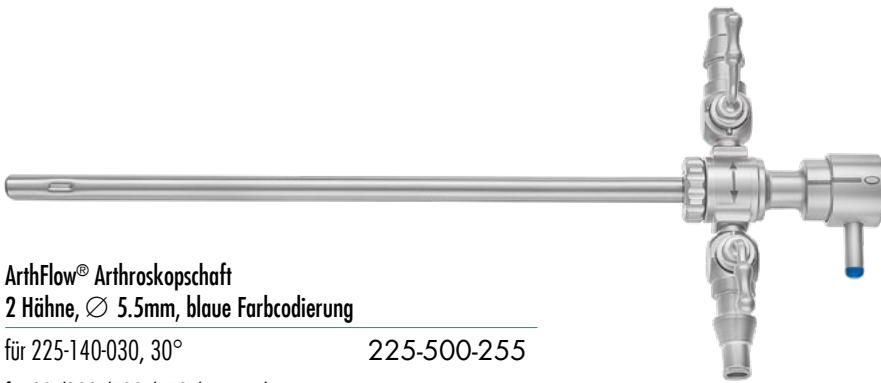

**ArthFlow® Arthroskopschaft
2 Hähne, Ø 5.5mm, blaue Farbcodierung**

für 225-140-030, 30°	225-500-255
für 0°/30°/70°/45°/universal	225-500-355

Ø 6.0mm, rote Farbcodierung, Highflow

für 30°	225-500-260
für 0°/30°/70°/45°/universal	225-500-360



**ArthFlow® Obturator / Trokar,
für Ø 5.5mm Operationsschaft, blaue Farbcodierung**

stumpf	225-500-555
scharf	225-500-655

für Ø 6.0mm Operationsschaft, rote Farbcodierung

stumpf	225-500-560
scharf	225-500-660



ArthVANCE® Zubehör

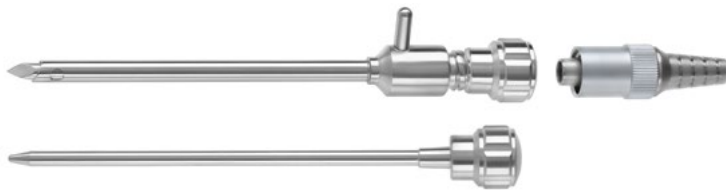

Inflow-Kanüle, komplettes Set mit Schaft, Trokar mit scharfer Spitze, stumpfer Obturator und Spüladapter

Ø 4.5mm 225-850-145



Spülkanülen Set mit 1 Hahn, inklusive Trokar und Obturator, 70mm Arbeitslänge

Ø 2.3mm 225-850-000

Ø 3.5mm 225-850-001



Obturator, 70mm Arbeitslänge, stumpf

Ø 2.3mm 225-850-002

Ø 3.5mm 225-850-004

Trokar, scharf

Ø 2.3mm 225-850-003

Ø 3.5mm 225-850-005



Operationschäfte und Trokare

Kanüle, 5.0mm 225-854-101

Kanüle, 5.5mm 225-854-102

Kanüle, 5.0mm, mit Hahn 225-854-103

Kanüle, 5.5mm, mit Hahn 225-854-104

Trokar, scharf, 5.0mm 225-854-105

Trokar, scharf, 5.5mm 225-854-106

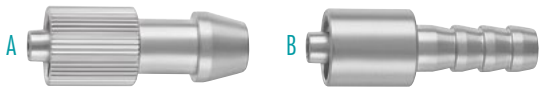

LuerLock Schlauchverbinder

A 9.0mm	300-011-181
B 6.0mm	300-011-506



Verschlusskappe, blau, Packung mit 10 Stück

∅ 5.5mm	300-023-905
---------	-------------



Einführ- und Wechselstab zur Verwendung mit Trokar Schaft

∅ 2.7mm x 230mm	225-865-027
∅ 3.5mm x 230mm	225-865-030
∅ 4.0mm x 230mm	225-865-040



ArthVANCE®





Instrumente für die Arthroskopie

Stanzen, Scheren und Faszangen

Die ArthVANCE® Instrumente bieten für alle Gelenke und Anatomien das richtige Modell.

- Flaches, stiftloses Mauldesign ermöglicht den Zugang sogar zu den kleinsten Gelenkzwischenräumen
- Einfache Reinigung dank LuerLock Anschluss
- Direkte Kraftübertragung auf das Maulteil
- 100% Made in Germany









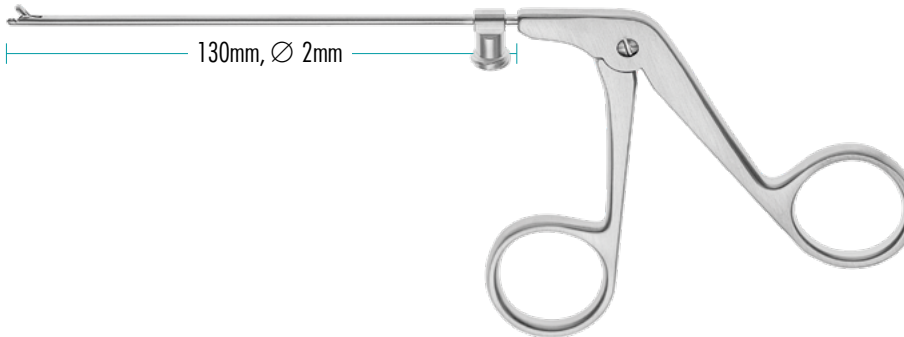



ArthVANCE® Mini Arthroskopie Instrumente

Kleine Gelenke

Ø 2.0mm





(Scale 1:1)

		Mini Stanze	225-305-020
		Mini Schere, abwärts schneidend	225-306-020
		Mini Löffelzange	225-307-020
		Mini Löffelzange, gezahnter Löffel	225-308-020
		Mini Fasszange	225-309-020
		Mini Schere, aufwärts schneidend	225-310-020
		Kurze Mini Schere, aufwärts schneidend	225-311-020

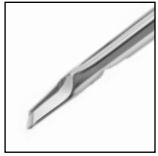
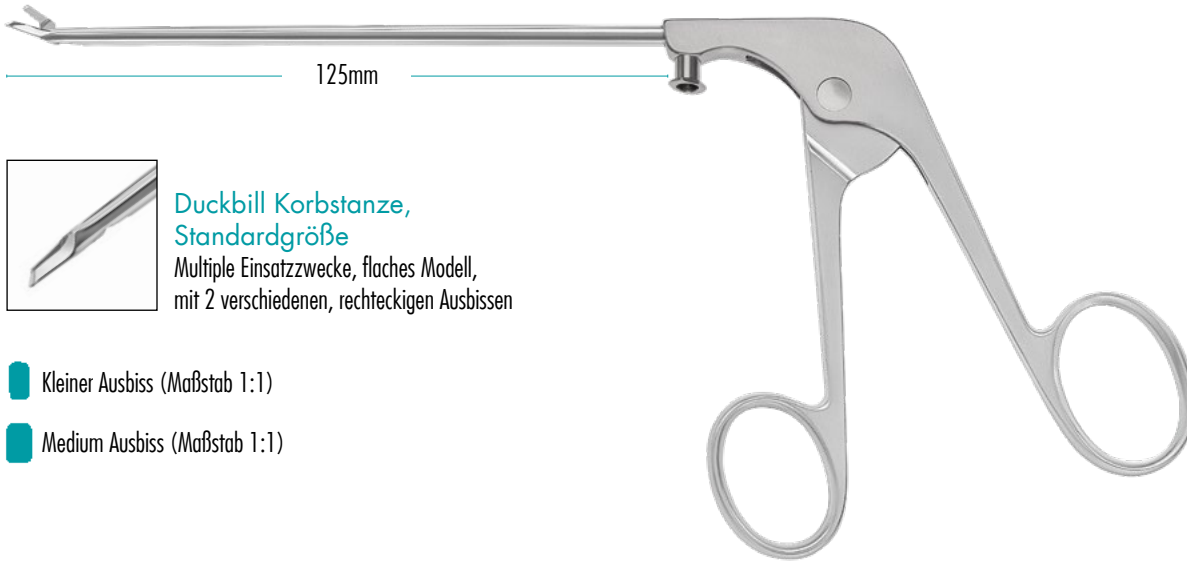
ArthVANCE® Arthroskopie Stanzen



Duckbill Korbstanze, Standardgröße
Multiple Einsatzzwecke, flaches Modell, mit 2 verschiedenen, rechteckigen Ausbissen

-  Kleiner Ausbiss (Maßstab 1:1)
-  Medium Ausbiss (Maßstab 1:1)



Duckbill Korbstanze, Ringgriff, gerader Schaft, gerades Maulteil

klein	225-800-101
medium	225-800-102

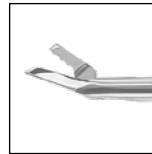

Upbiter

klein	225-800-104
-------	-------------

links gebogener Schaft, upbiter Maul

medium	225-800-107
--------	-------------

rechts gebogener Schaft, upbiter Maul

medium	225-800-109
--------	-------------

Mini Stanzen

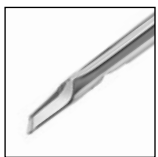
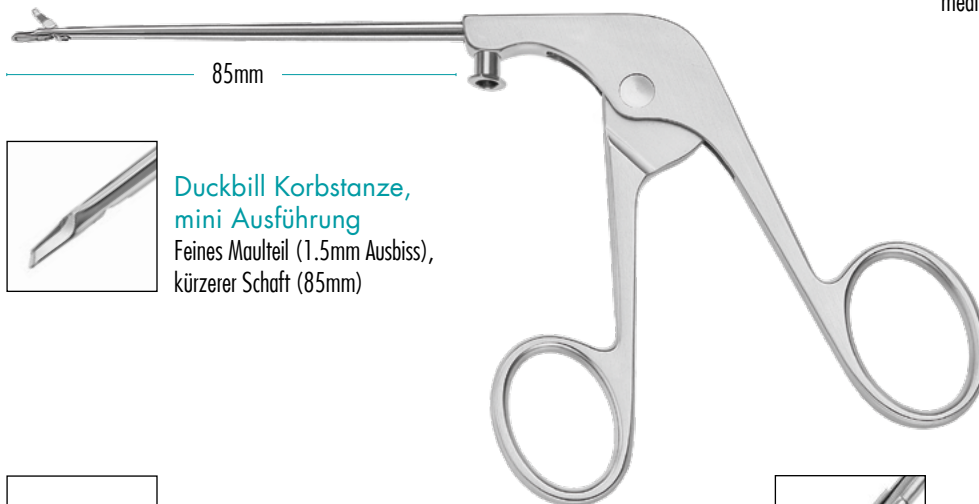

Duckbill Korbstanze, mini Ausführung
Feines Maulteil (1.5mm Ausbiss), kürzerer Schaft (85mm)

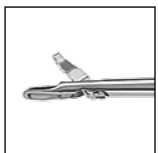

Duckbill Mini Korbstanze, Ringgriff, gerader Schaft

Gerades Maulteil	225-810-102
upbiter Maulteil	225-810-105
Gerades Maulteil links gebogener Schaft	225-810-107
Gerades Maulteil rechts gebogener Schaft	225-810-109



Rongeur, gerades Maulteil, gerader Schaft, Ringgriff

95mm Arbeitslänge	225-810-930
125mm Arbeitslänge	225-800-920
220mm Arbeitslänge	225-830-920

ArthVANCE® Arthroskopie Stanzen

Kleiner Ausbiss (Maßstab 1:1)

Mittlerer Ausbiss (Maßstab 1:1)

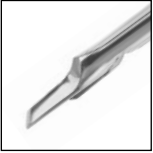

Duckling Korbstanze

Weiterentwickeltes Duckling Niederquerschnitts-Maulteil, flaches oberes Maulteil lässt sich komplett in das Untere absenken.



Duckling Elevator Korbstanze

Mit flacher Schaufel für einfachen Zugang.



Duckling Korbstanze, 125mm Arbeitslänge, gerader Schaft, Ringgriff

klein	225-800-401
medium	225-800-402



Ringgriff

medium	225-800-420
--------	-------------



Pro Griff

medium	225-700-402
--------	-------------

Ausbiss (Maßstab 1:1)



Slimline Korbstanze

Der schmale Schaft und das kompakte Mauldesign ermöglicht den Zugang in enge Anatomien.



Ringgriff, gerader Schaft, gerades Maulteil, 125mm Arbeitslänge

klein	225-800-002
-------	-------------



45° gewinkelttes Maulteil

links	225-800-003
rechts	225-800-004



Ausbiss (Maßstab 1:1)



Backbiter

Die BackBiter Korbstanze ermöglicht den Zugang zum Meniskus Vorderhorn.

Ringgriff, gerader Schaft, 125mm Arbeitslänge

links schneidend	225-800-707
------------------	-------------

Ausbiss (Maßstab 1:1)



Oval Stanze

Bietet den niedrigsten Querschnitt und größten Ausbiss für finales als auch laterales Schneiden. Die "Allrounder" Stanze.

Ringgriff, gerader Schaft, 125mm Arbeitslänge

gerades Maulteil 225-800-202

Ovale Mini Stanze, 95mm Arbeitslänge

gerades Maulteil 225-810-202

Maul links 225-810-203

Maul rechts 225-810-204



Blunt Nose

Erzeugt eine bündige Kontuierung des Meniskus

Ringgriff, gerader Schaft, 85mm Arbeitslänge

gerades Maulteil 225-810-302

Ausbiss (Maßstab 1:1)



Korbstanze SCOOP

Korbstanzen sind die typischen Instrumente mit klassischer Stanzenform und dem Papageienschnabel am oberen Maulteil für einen sicheren Griff des Gewebes.

Ringgriff, gerader Schaft, 125mm Arbeitslänge

1.0mm, gerades Maulteil 225-800-802

1.3mm, Maul aufgewinkelt 225-800-805

1.3mm, Maul abgewinkelt 225-800-806



Side Cutter

Diese Stanzen erlauben einfachen Zugang zum vorderen Meniskus. Der speziell dafür gestaltete Zigarrenhandgriff macht aus allen Side Cutters „Rotator“ Stanzen.

Ausbiss (Maßstab 1:1)



Zigarrenhandgriff, gerader Schaft, 85mm Arbeitslänge

linksseitiger Schnitt 225-810-955



Zigarrenhandgriff, gerader Schaft, 85mm Arbeitslänge

rechtsseitiger Schnitt 225-810-957

ArthVANCE® Fasszange



Shark Fasszange
Mit stumpfen 1x2 Zähnen und gerieftem, inneren Maulteil.

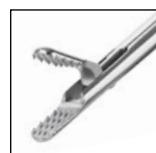

Alligator Fasszange
Kurzes Maulteil mit mehrfacher Zahnung



Shark Fasszange, Pro Griff, 125mm Arbeitslänge, gerader Schaft
gerades Maulteil 225-700-820



Alligator Fasszange, Pro Griff, 125mm Arbeitslänge, gerader Schaft
2.7mm gerades Maulteil 225-700-825



Slide Lock Griff, 125mm Arbeitslänge
gerades Maulteil 225-800-820



Slide Lock Griff, 125mm Arbeitslänge
2.7mm gerades Maulteil 225-800-825

Mini Shark, 85mm Arbeitslänge
gerades Maulteil 225-810-820

Mini Alligator, 85mm Arbeitslänge
gerades Maulteil 225-810-825



Löffel Fasszange
Löffel Maulteil mit atraumatischer Zahnung



Löffel Fasszange, gerader Schaft, 125mm Arbeitslänge, 3.3mm gerades Maulteil
Pro Griff 225-700-833



125mm Arbeitslänge, 2.7mm gerades Maulteil
Slide Lock Griff 225-800-832

ArthVANCE® Schere



Hakenschere

Hakenschere, gerades Maulteil, Ringgriff, 125mm Arbeitslänge

gerader Schaft	225-800-472
15° links gebogener Schaft	225-800-477
15° rechts gebogener Schaft	225-800-479

Mini Hakenschere, 2.7mm gerades Maulteil, 85mm Arbeitslänge

gerader Schaft	225-810-472
----------------	-------------





ArthVANCE® Suture Cutter

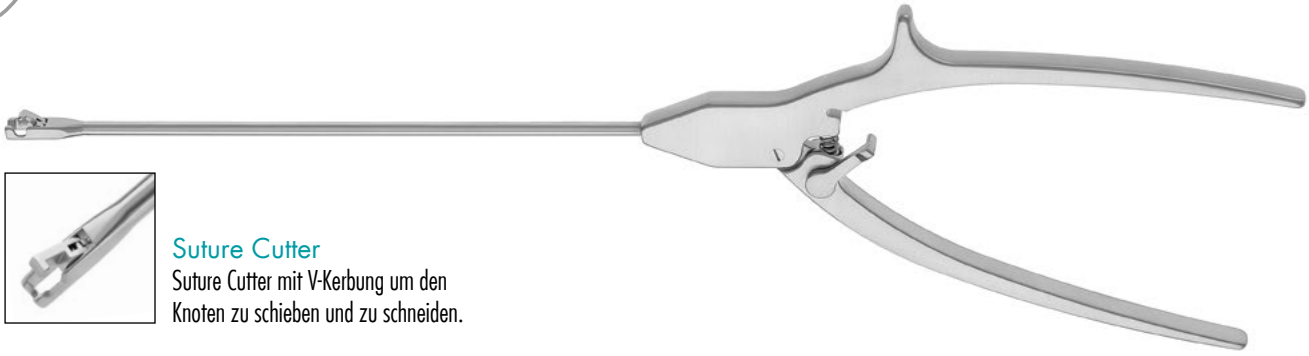

Suture Cutter

Suture Cutter mit V-Kerbung um den Knoten zu schieben und zu schneiden.



Suture Cutter, V-Kerbung, links öffnend, Axialgriff

155mm Arbeitslänge 225-820-100

ArthVANCE® Saugstanzen

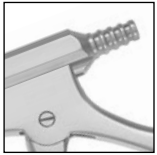

Saugstanzen

Saugstanzen haben einen universellen Schlauchanschluss um gleichzeitig Gewebe, Knorpel oder Knochenteile abzuschneiden und abzusaugen.



Scoop Stanze, Ø 4.5mm

110mm Arbeitslänge 225-697-045



Scoop Stanze, Ø 5.0mm

110mm Arbeitslänge

225-697-050

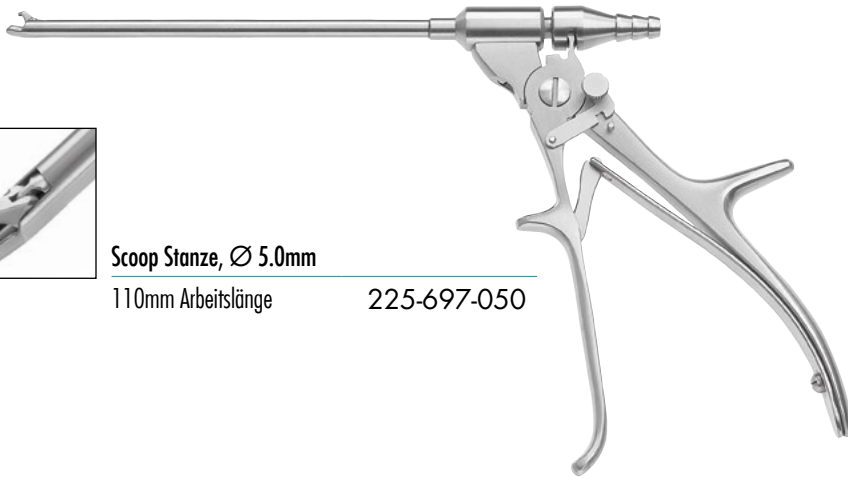

Retrograde Saugstanze, Ø 2.7mm,
mit Schlauchanschluss,
110mm Arbeitslänge

360° rotierbar

225-699-027



ArthVANCE®

Instrumente für die Arthroskopie

Haken, Sonden und Küretten

ArthVANCE® Instrumente bieten das richtige Modell für alle Gelenke und Anatomien.





ArthVANCE® Sonden



Hakensonde, Kunststoffhandgriff

225-600-004



Tastsonde, graduiert

gerade 225-090-001

gebogen 225-090-002



Tastsonde, graduiert, 75mm Arbeitslänge

Ø1.5mm 225-100-115



Tastsonde, graduiert, 140mm Arbeitslänge

Ø2.3mm 225-100-123



Tastsonde, 5mm graduiert, Dreiecksgriff

Ø3.5mm 225-400-002

Ø5.0mm 225-400-004



Hakensonde und Retraktor, 40mm Arbeitslänge

45° gebogen, 3mm Haken 225-400-103

90° gewinkelt, 2mm Haken 225-400-102

ArthVANCE® Küretten / Löffel



Größe 1
(Maßstab 1:1)



Größe 2
(Maßstab 1:1)



Größe 3
(Maßstab 1:1)



Größe 1
(Maßstab 1:1)



Größe 2
(Maßstab 1:1)



Größe 3
(Maßstab 1:1)



Kürette, 10° gewinkelt, 130mm Arbeitslänge

Größe 1, Ø 2.0mm	225-600-511
Größe 2, Ø 2.3mm	225-600-512
Größe 3, Ø 3.3mm	225-600-513



Kürette, 20° gewinkelt, scharf an beiden Seiten, 130mm Arbeitslänge

Größe 1, Ø 2.0mm	225-600-521
------------------	-------------



Löffel, 5° leicht gebogen, 130mm Arbeitslänge

Größe 1, Ø 3.0 x 4.4mm	225-600-401
Größe 2, Ø 3.3 x 5.5mm	225-600-402
Größe 3, Ø 4.0 x 7.0mm	225-600-403



Mini Kürette, scharf, gerade, gerändelter Griff, 90mm Arbeitslänge

Ø2.0mm	225-090-009
--------	-------------



Kürette, scharf, 30° gewinkelt, gerändelter Griff, 130mm Arbeitslänge

Ø3.0mm	225-100-006
--------	-------------



Ring Kürette, scharf, 30° gewinkelt, gerändelter Griff, 130mm Arbeitslänge

Ø3.0mm	225-100-008
Ø5.0mm	225-100-009



Kürette, scharf, Ø3mm, Dreiecksgriff

30° gewinkelt	225-400-006
15° gewinkelt	225-400-008

Ø7mm

30° gewinkelt	225-400-009
---------------	-------------

ArthVANCE® Meniskotome / Messer



Smillie Meniskotom, gerade Kante, Dreiecksgriff

3.0mm 225-400-020
5.0mm 225-400-022

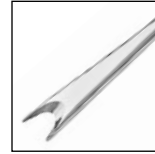

Smillie Meniskotom, gebogene Kante, Dreiecksgriff

7.0mm 225-400-023



Smillie Meniskotom, gerade Kante, gerändelter Griff, 130mm Arbeitslänge

3.0mm 225-100-020
5.0mm 225-100-022

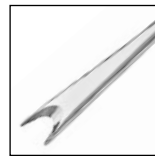

Smillie Meniskotom, gebogene Kante, gerändelter Griff, Dreiecksgriff, 130mm Arbeitslänge

7.0mm 225-100-023



Rosetten Messer, Dreiecksgriff

3.0mm 225-400-025



Bananenmesser, glatt, Dreiecksgriff

225-400-029



Skalpell Messer, Dreiecksgriff

225-400-034



Hakenmesser, Dreiecksgriff

90° gewinkelt 225-400-038

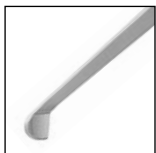

Retrogrades Messer, Dreiecksgriff

45° 225-400-041



Diamantraspel, Dreiecksgriff

45° gewinkelt 225-400-045



Sichelmesser, Dreiecksgriff

225-400-043



Diamantraspel, Dreiecksgriff

90° gewinkelt 225-400-090



**Rosettenmesser, gerändelter Griff,
130mm Arbeitslänge**

3.0mm 225-100-025



**Bananmesser, glatt, gerändelter Griff,
130mm Arbeitslänge**

225-100-029



**Skalpellmesser, gerändelter Griff,
130mm Arbeitslänge**

225-100-034



**Hakenmesser, gerändelter Griff,
130mm Arbeitslänge**

90° gewinkelt 225-100-038



**Retrograde Messer, gerändelter Griff,
130mm Arbeitslänge**

45° 225-100-041



**Smillie Meniskotom, gerade Schnittkante,
130mm Arbeitslänge**

3mm breit 225-100-020



**Mini Skalpell, gerändelter Griff,
90mm Arbeitslänge**

∅ 2.0mm 225-090-006

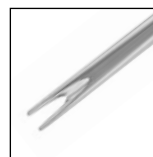

**Mini Messer, gerändelter Griff,
90mm Arbeitslänge**

∅ 1.5mm 225-090-007



**Mini Sichelmesser, gerändelter Griff,
90mm Arbeitslänge**

∅ 3.0mm 225-090-008



**Mini Raspel, gerändelter Griff,
90mm Arbeitslänge**

konkaves Maul 225-090-004



**Mini Raspel, gerändelter Griff,
90mm Arbeitslänge**

konvexes Maulteil 225-090-005

**Micro Chondro Pick**

25° gewinkelt

225-600-125

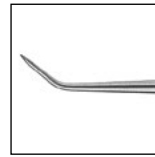
**Micro Chondro Pick**

45° gewinkelt

225-600-145

**Micro Chondro Pick**

60° gewinkelt

225-600-160

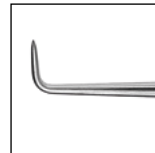
**Micro Chondro Pick**

90° gewinkelt

225-600-190

**Mini Lambotte Osteotom, 125mm**

2mm 210-136-002

3mm 210-136-003

4mm 210-136-004

5mm 210-136-005

6mm 210-136-006

**Walter Osteotom, 190mm**

2mm 420-580-002

3mm 420-580-003

4mm 420-580-004

**Hammer, bleigefüllter Kopf, 80g**

Ø 20mm 210-220-080

**Partsch Hammer, 120g**

Ø 22mm 210-225-180

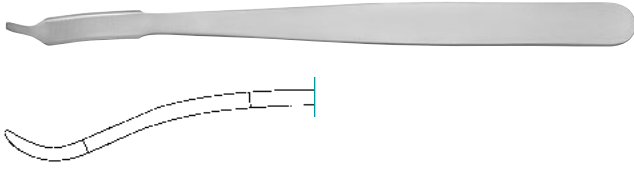

Mini Hohmann Knochenheber, 2mm Spitze, 160mm

6mm breit 210-539-060

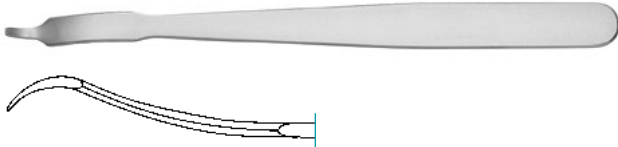

Hohmann Knochenheber, 2mm Spitze, 160mm

8mm breit 210-541-080

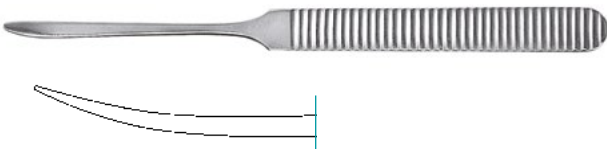

Williger Elevator, 160mm

5.5mm breit 210-395-160

7.0mm breit 210-396-170



**Monopolare Nadelelektrode, 90° gewinkelt,
115mm Arbeitslänge, 2.4mm Anschluss**

Ø 1.5 x 0.6mm 225-710-001



**Monopolare Nadelelektrode, 90° gewinkelt,
115mm Arbeitslänge, 2.4mm Anschluss**

Ø 4.0 x 0.6mm 225-710-001

Arthroskopie Shaver System STUNNER S1

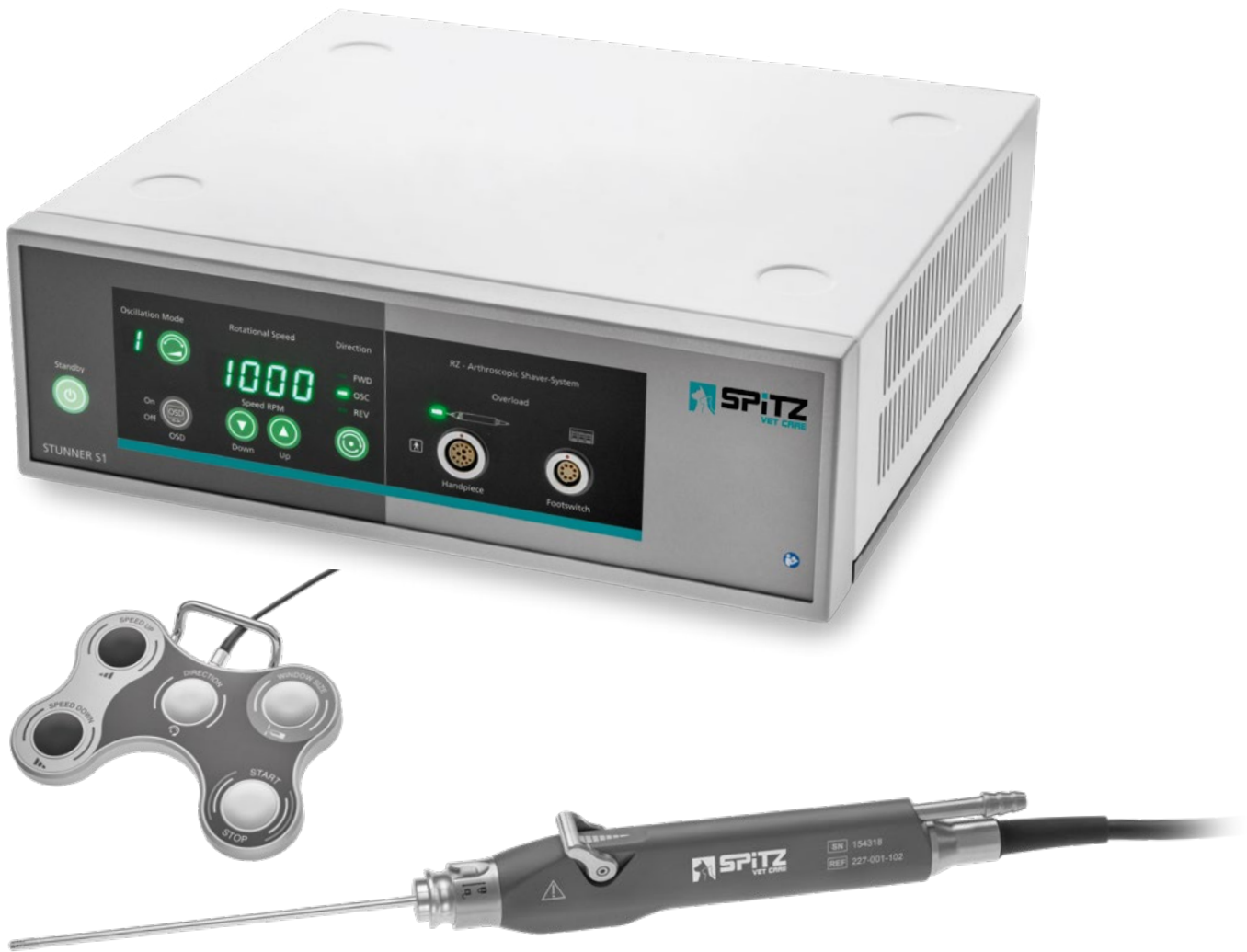

Features:

- 9 Oszillationsmodi
- Steuerbar über Tasten auf dem Handstück oder dem Fußschalter
- Ergonomisches Handstück, komplett autoklavierbar
- Passende Shaver Klängen
- Open window Funktion
- OSC bis 3500 U/min.

STUNNER S1 Steuergerät, komplett mit Handstück und Fußschalter

110 - 230V 227-001-110V

Steuergerät

227-001-101V

Handstück

227-001-102V

Fußschalter

227-001-103V



Shaver Klingen



**DR PitBull
Shaver Klingen**
Die Universalklinge für weiches
oder hartes Gewebe



**DR WAVER Cutter
Shaver Klingen**
Die perfekte Klinge für weiche
Geweberesektion

Unsteril, 85mm Arbeitslänge

Ø 3.0mm 227-016-013

130mm Arbeitslänge

Ø 3.0mm 227-016-113

Ø 4.0mm 227-016-114

Unsteril, 85mm Arbeitslänge

Ø 2.0mm 227-016-002

Ø 3.0mm 227-016-003

130mm Arbeitslänge

Ø 3.0mm 227-016-103

Ø 4.0mm 227-016-104

➔ mehr Modelle auf Anfrage erhältlich

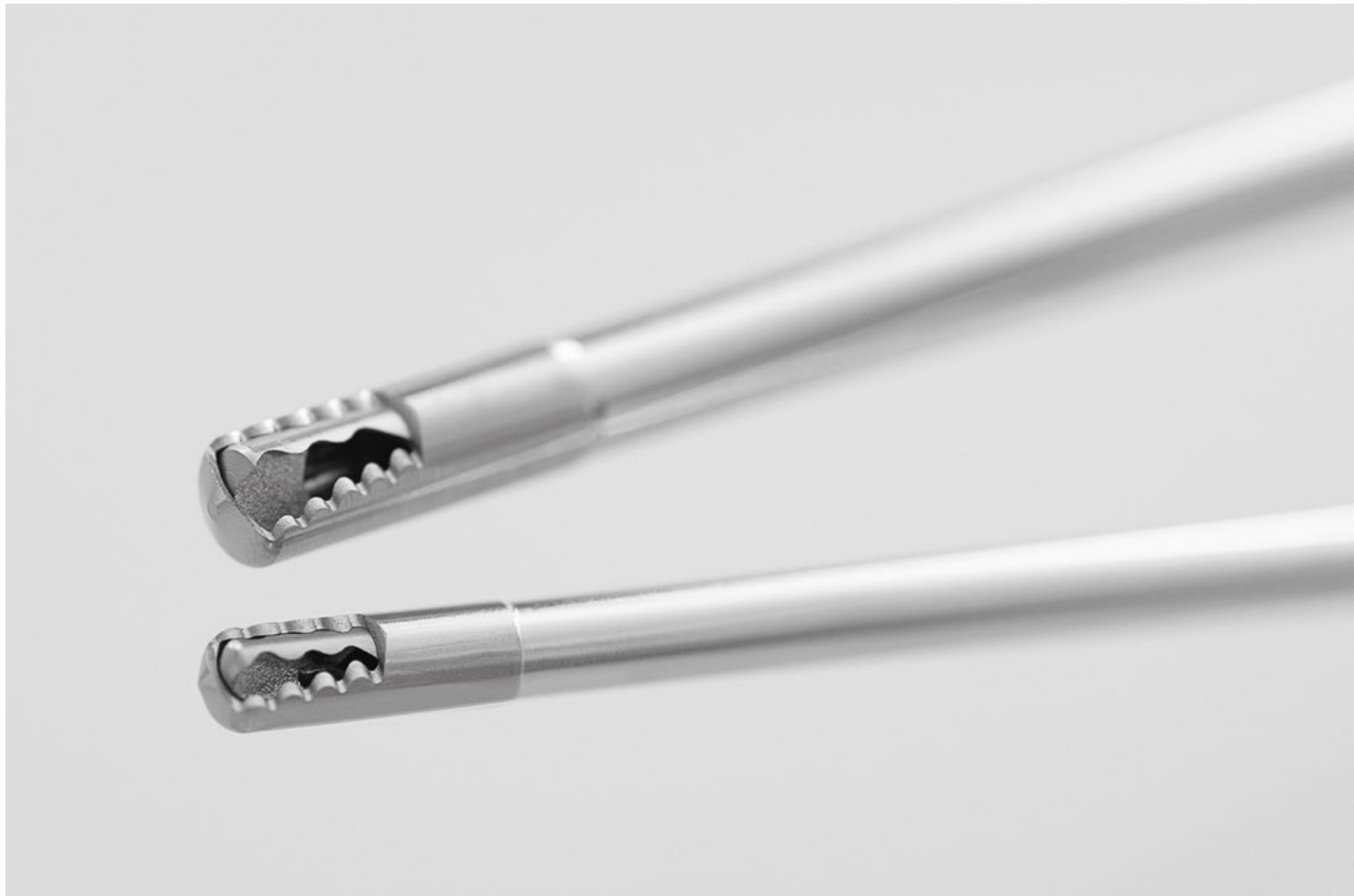



Arthroskopie Pumpe P1

- Hydrostatische Druckregulation
- Silikon Schlauchset inklusive (225-910-001)
- Einfach zu bedienendes, spritzwassergeschütztes Display
- Äußerst zuverlässige Schlauchführung und Handhabung
- Rutschfeste Standfüße

Arthroskopie Pumpe P1

110 - 230V	225-906-000V
Spülschlauch Set, Silikon, autoklavierbar (inklusive)	225-910-001
Spülschlauch Set, PVC, 20 Stück, Tagesschlauch, steril (optional)	225-910-002
Patientenschlauch, PVC, 40 Stück, steril (optional)	225-910-003



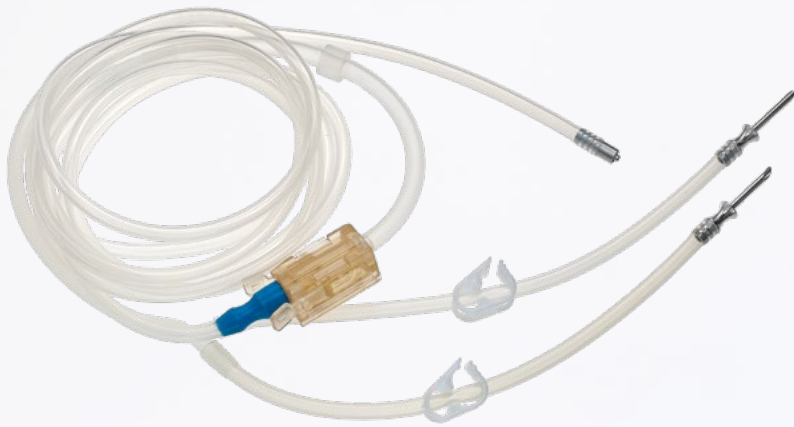

Silikonschlauchset (inklusive)

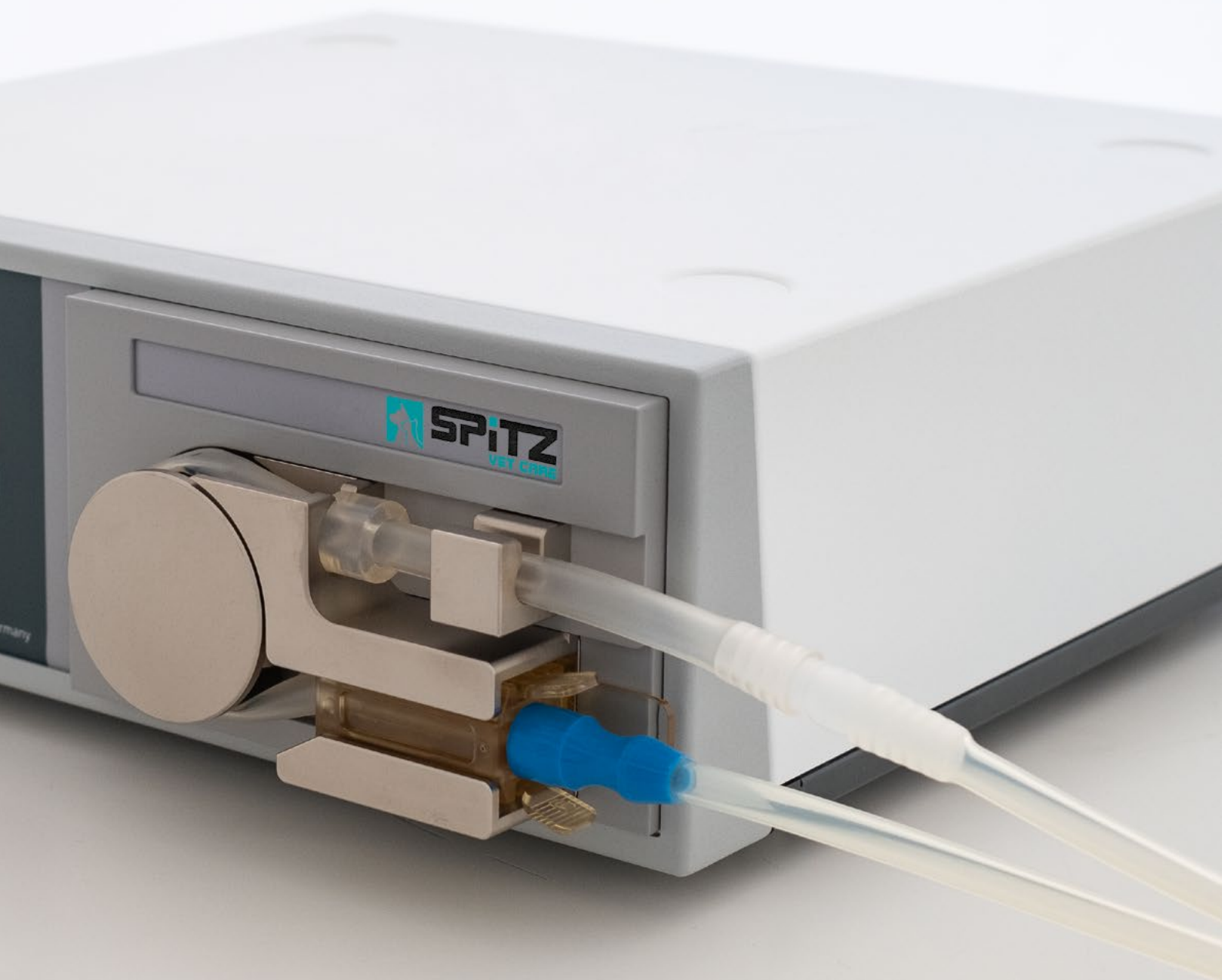



Container für Arthroskopie, für 8 Instrumente
in aufrechter Position und Platz für weitere
Instrumente

600-513-000

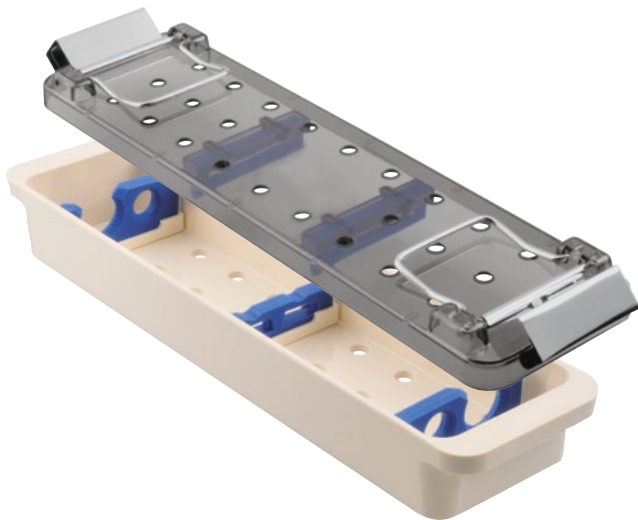

Safe+Clean zweifach Endoskop Sterilisations
Container für 2 kurze Endoskope mit maximaler
Länge von 190mm

271 x 70 x 35 mm

600-505-002

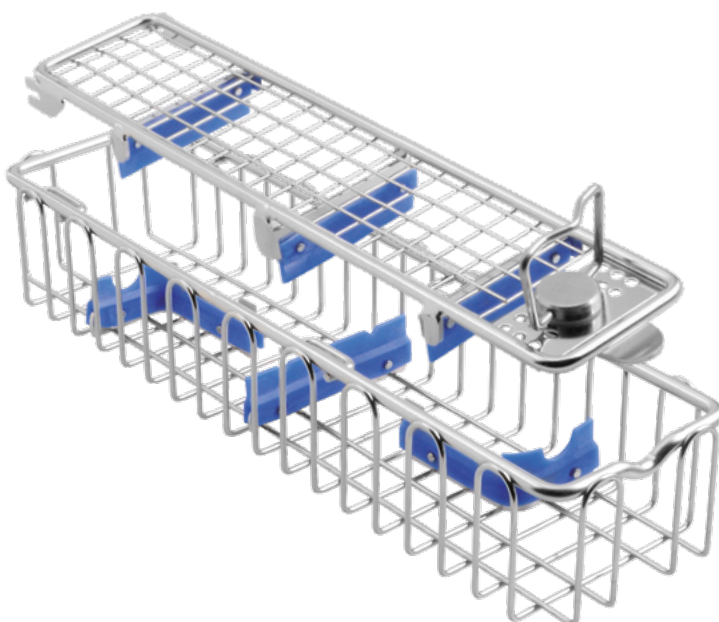

Endoskop-Reinigungskorb, mit Silikonleisten
an Boden und Deckel, für max. 2 Endoskope
(190mm Länge)

290 x 80 x 52 mm

600-292-052



Endoskop Austauschprogramm

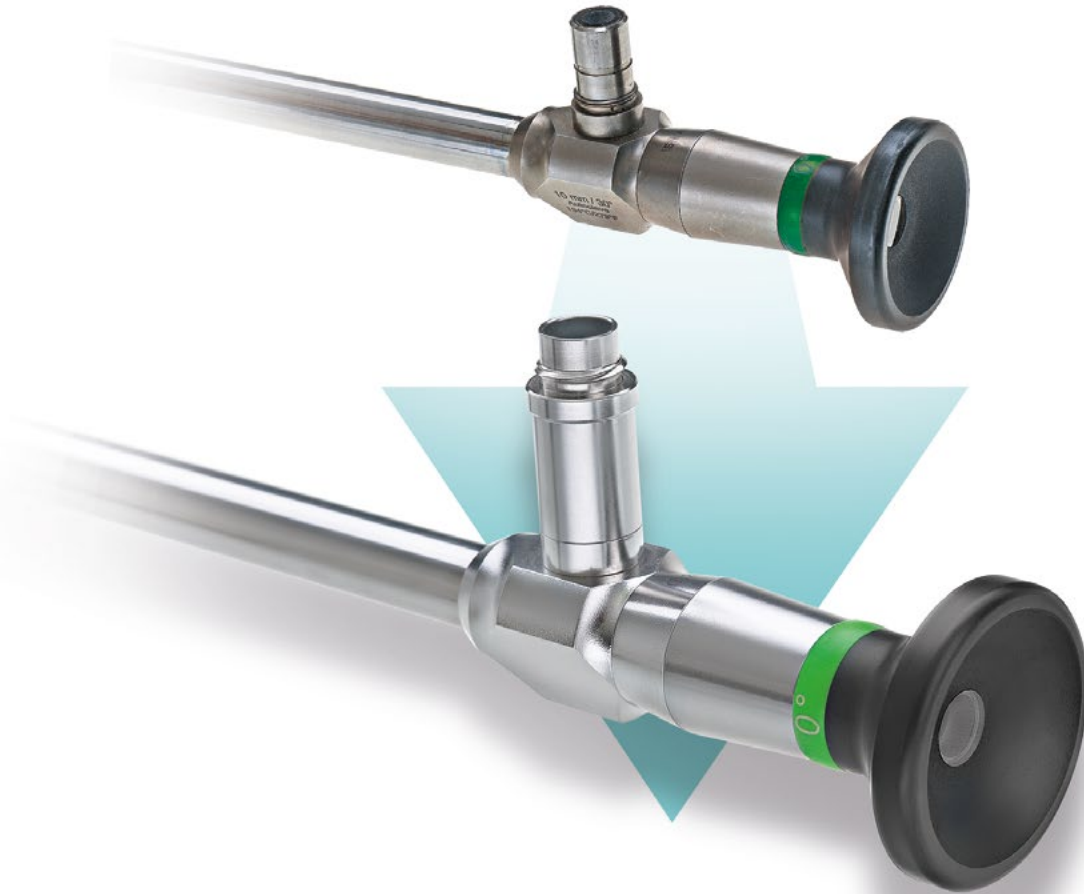

- Senden Sie uns ihr beschädigtes oder gebrauchtes Endoskop, unabhängig vom Hersteller, und wählen Sie ein neues Endoskop aus unserem Katalog zum Austauschpreis
- Senden Sie uns JEDEN Endoskopie-Typ und wählen Sie ein Neues aus dem SPiTZ-Portfolio
- Erhalten Sie ein brandneues SPiTZ-Endoskop mit voller Garantie
- Alle Komponenten sind neu, kein „Economy Class“ Produkt, keine recycelten oder wiederaufbereiteten Teile
- Festpreise für ein transparentes Budget

laparoskopie.







SPITZ ENDOSKOPE

- 3-Stufen-Schnelladapter zum Anschluss der gängigsten Lichtkabel direkt an das Endoskop
- Saphirgläser sorgen für höchste Stabilität gegen Beschädigungen am Linsensystem
- Optimierte Glasfaseranordnungen sorgen für eine gleichmäßige Helligkeit im Bild und ermöglichen so die Bildwiedergabe in höchster Qualität
- Full-HD- und 4K-High-Definition-Bilder mit erhöhter Detailauflösung durch neueste CAD-konstruierte Stablinsensysteme
- Vollständig autoklavierbar bei 134 °C und 2,3 bar

4K LAPAROSKOPE

Modernste Laparoscope für eine hervorragende Bildqualität und feinste Details in Ultra High Definition.

4K



4K Laparoskop, Ø 10mm, 330mm Arbeitslänge

0°	300-100-400
30°	300-100-430

450mm Arbeitslänge

0°	300-200-400
30°	300-200-430



4K Laparoskop, Ø 5mm, 300mm Arbeitslänge

0°	300-155-400
30°	300-155-430

450mm Arbeitslänge

0°	300-255-400
30°	300-255-430



FullHD Laparoscope



Laparoskop, \varnothing 10mm, 330mm Arbeitslänge

0°	300-091-100
30°	300-091-130
45°	300-091-145
70°	300-091-170

430mm Arbeitslänge

0°	300-091-430
30°	300-091-433



Laparoskop, \varnothing 5mm, 300mm Arbeitslänge

0°	300-092-100
30°	300-092-130



Mini-Laparoskop, \varnothing 2.9mm, 207mm Arbeitslänge

0°	300-097-100
30°	300-097-130

FULL HD



Operationslaparoskop, Ø 10mm, mit Instrumentenkanal
(Ø 6mm), 270mm Arbeitslänge, parallele Sicht

0°

300-099-006

Ø
10 mm



Operationslaparoskop, Ø 10mm, mit Instrumentenkanal
(Ø 6mm), 270mm Arbeitslänge, laterale Sicht

0°

300-099-106

Ø
10 mm

FULL HD

Saugen und Spülen



**Saug-Spülkanüle mit LuerLock, 4 Löcher,
340mm Arbeitslänge**

∅ 3mm 300-192-003

∅ 5mm 300-192-005

∅ 10mm 300-192-010

250mm Arbeitslänge

∅ 3mm 300-192-253



**Saug-Spülgriff, rotierbar, 2-Wege-Hebelmechanismus
2 große, universelle Spülanschlüsse mit LuerLock**

300-192-000



**Saug-Spülkanüle, 4 Löcher,
340mm Arbeitslänge**

∅ 3mm	300-172-003
∅ 5mm	300-172-005
∅ 10mm	300-172-010

250mm Arbeitslänge

∅ 3mm	300-172-253
-------	-------------



4x4 Löcher, 340mm Arbeitslänge

∅ 3mm	300-173-003
-------	-------------

250mm Arbeitslänge

∅ 3mm	300-173-253
-------	-------------



**Pistolenförmiger Saug-Spülgriff mit 2-Wege Ventil
und 2 großen, universellen Schlauchanschlüssen**

300-166-100





HF Elektroden



ohne
Absaugung



mit
Absaugung



Monopolare Spatelektrode,
Ø 5mm, mit Keramikspitze,
360mm Arbeitslänge

ohne Absaugung

300-144-002

mit Absaugung

300-145-003



Monopolare L-Hakenelektrode,
Ø 5mm, mit Keramikspitze,
360mm Arbeitslänge

ohne Absaugung

300-144-005

mit Absaugung

300-145-005



Monopolare J-Hakenelektrode,
Ø 5mm, mit Keramikspitze,
360mm Arbeitslänge

ohne Absaugung

300-144-004

mit Absaugung

300-145-004



Monopolare Nadelektrode,
Ø 5mm, mit Keramikspitze,
360mm Arbeitslänge

ohne Absaugung

300-144-006

mit Absaugung

300-145-006

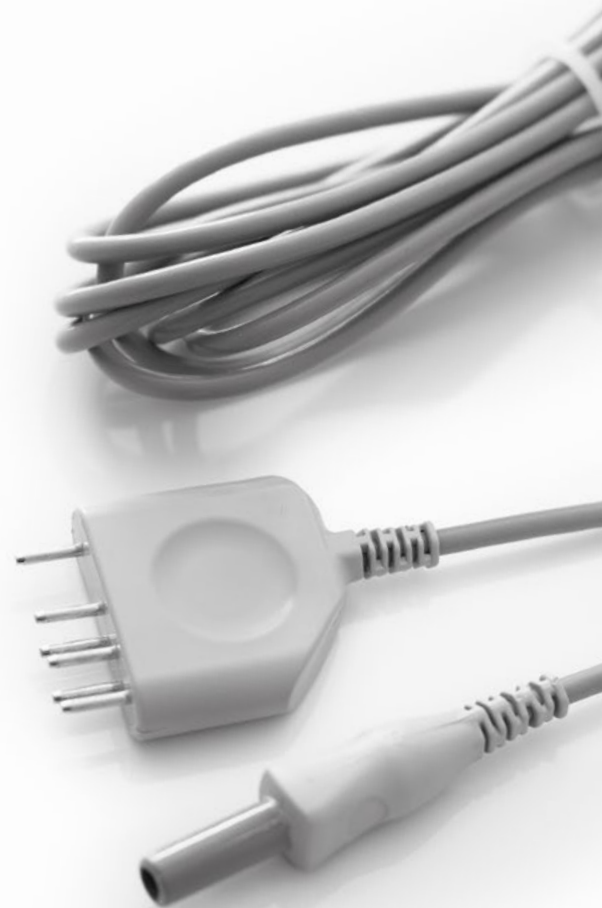

Monopolae HF Kabel

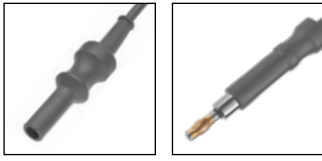

Erbe/ACC/ICC

3m	700-101-030
5m	700-101-050

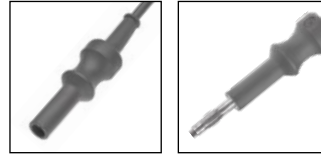

Erbe/Martin/Berchtold

3m	700-280-030
5m	700-280-050

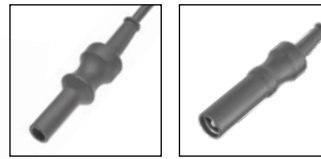

Martin/Berchtold

3m	700-285-030
5m	700-285-050

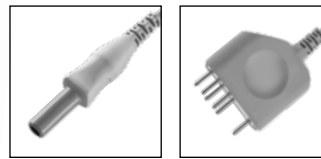

SPITZ HF Gerät SDS Anschluss

3m	700-501-300
5m	700-501-500

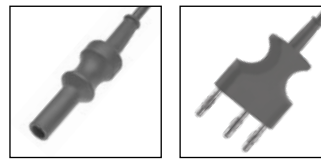

SPITZ HF Gerät Standard Anschluss

3m	700-501-303
5m	700-501-503

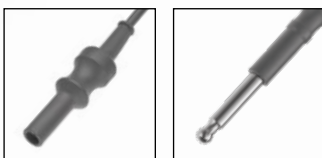

Bovie, Valleylab, Conmed

3m	700-360-031
5m	700-360-051

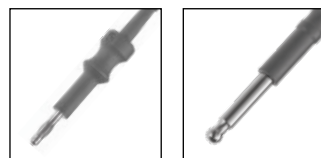

Bovie, Valleylab, Conmed

3m	700-370-030
5m	700-370-050



Multiport Trokar System

- Wiederverwendbare und autoklavierbare Dichtungen
- Einfaches Öffnen durch Betätigen des Hebels
- Absperrhahn aus Edelstahl
- Ergonomisches Gehäuse aus Edelstahl
- Selbstzentrierende Hülsen



MultiPort Hebel



Farbcodiert



Metallgehäuse

Farbcodierung	
Ø 5.5mm	●
Ø 11.0mm	●
Ø 13.0mm	●

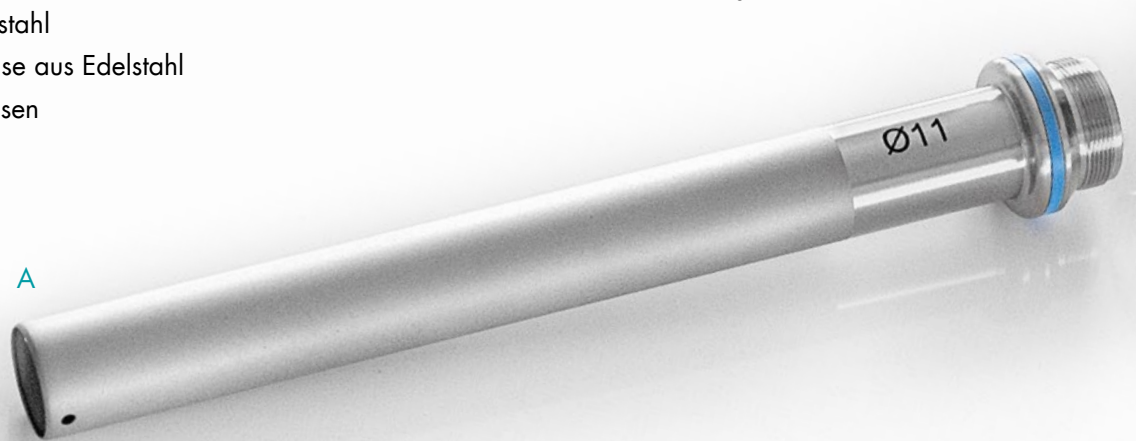

A



Komplett mit glatter Metallhülse,
105mm Arbeitslänge A+B

Ø 5.5mm	300-220-055
Ø 11.0mm	300-220-011
Ø 13.0mm	300-220-013

150mm Arbeitslänge

Ø 5.5mm	300-220-155
Ø 11.0mm	300-220-111
Ø 13.0mm	300-220-113

Ersatzhülse A

Ø 5.5mm	300-220-255
Ø 11.0mm	300-220-211
Ø 13.0mm	300-220-213



Komplett mit Gewinde Metallhülse,
105mm Arbeitslänge A+B

Ø 5.5mm	300-221-055
Ø 11.0mm	300-221-011
Ø 13.0mm	300-221-013

Ersatzhülse A

Ø 5.5mm	300-221-255
Ø 11.0mm	300-221-211
Ø 13.0mm	300-221-213



Komplett mit selbstschneidender Metallhülse,
105mm Arbeitslänge A+B

Ø 5.5mm	300-226-055
Ø 11.0mm	300-226-011
Ø 13.0mm	300-226-013

Ersatzhülse A

Ø 5.5mm	300-236-255
Ø 11.0mm	300-236-211
Ø 13.0mm	300-236-213



Multiport Trokar mit spezieller Größe,
abgeschrägte Hülse, 110mm Arbeitslänge A+B

Ø 15.0mm	300-020-015
----------	-------------

119mm Arbeitslänge A+B

Ø 20.0mm	300-020-020
----------	-------------

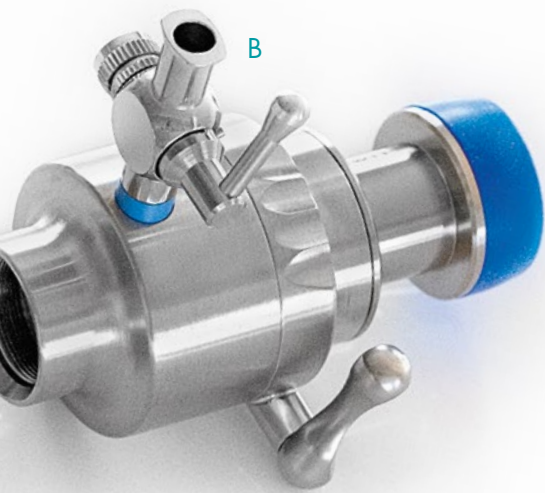

Komplett mit glatter Metallhülse, abgeschrägt,
105mm Arbeitslänge **A+B**

Ø 5.5mm	300-222-055
Ø 11.0mm	300-222-011
Ø 13.0mm	300-222-013

Ersatzhülse **A**

Ø 5.5mm	300-222-255
Ø 11.0mm	300-222-211
Ø 13.0mm	300-222-213



Komplett mit glatter Synthetikhülse,
105mm Arbeitslänge **A+B**

Ø 5.5mm	300-233-055
Ø 11.0mm	300-233-011
Ø 13.0mm	300-233-013

Ersatzhülse **A**

Ø 5.5mm	300-233-255
Ø 11.0mm	300-233-211
Ø 13.0mm	300-233-213



Komplett mit Gewinde Synthetikhülse,
105mm Arbeitslänge **A+B**

Ø 5.5mm	300-234-055
Ø 11.0mm	300-234-011
Ø 13.0mm	300-234-013

Ersatzhülse **A**

Ø 5.5mm	300-234-255
Ø 11.0mm	300-234-211
Ø 13.0mm	300-234-213



Multiport Mini Trokar,
70mm Arbeitslänge **A+B**

Ø 3.5mm	300-112-035
---------	-------------



Multiport Mini Trokar, Gewinde Metallhülse
70mm Arbeitslänge **A+B**

Ø 5.5mm Gewinde	300-221-755
Ø 5.5mm Gewinde, selbstschneidend	300-226-755



Siliport Trokar System

- Wiederverwendbare und autoklavierbare Dichtungen
- Wiederverwendbares und autoklavierbares Silikonventil
- Absperrhahn aus rostfreiem Stahl
- Leichtes Kunststoffgehäuse
- Selbstzentrierende Hülsen

Farbcodierung

- Ø 5.5mm ●
- Ø 11.0mm ●
- Ø 13.0mm ●



A



Komplett mit glatter Metallhülse,
105mm Arbeitslänge A+B

Ø 5.5mm	300-230-055
Ø 11.0mm	300-230-011
Ø 13.0mm	300-230-013

150mm Arbeitslänge

Ø 5.5mm	300-230-155
Ø 11.0mm	300-230-111
Ø 13.0mm	300-230-113

Ersatzhülse A

Ø 5.5mm	300-220-255
Ø 11.0mm	300-220-211
Ø 13.0mm	300-220-213



Komplett mit Gewinde Metallhülse,
105mm Arbeitslänge A+B

Ø 5.5mm	300-231-055
Ø 11.0mm	300-231-011
Ø 13.0mm	300-231-013

Ersatzhülse A

Ø 5.5mm	300-221-255
Ø 11.0mm	300-221-211
Ø 13.0mm	300-221-213



Komplett mit selbstschneidender Metallhülse,
105mm Arbeitslänge A+B

Ø 5.5mm	300-236-055
Ø 11.0mm	300-236-011
Ø 13.0mm	300-236-013

Ersatzhülse A

Ø 5.5mm	300-236-255
Ø 11.0mm	300-236-211
Ø 13.0mm	300-223-213



Leichtes Kunststoff-
gehäuse



Farbcodiert



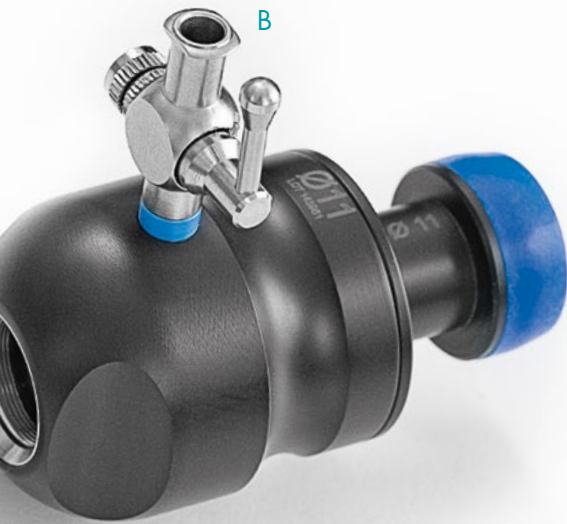

Komplett mit glatter Metallhülse, abgeschragt,
105mm Arbeitslänge A+B

Ø 5.5mm	300-232-055
Ø 11.0mm	300-232-011
Ø 13.0mm	300-232-013

Ersatzhülse A

Ø 5.5mm	300-222-255
Ø 11.0mm	300-222-211
Ø 13.0mm	300-222-213



Komplett mit glatter Synthetikhülse,
105mm Arbeitslänge A+B

Ø 5.5mm	300-233-055
Ø 11.0mm	300-233-011
Ø 13.0mm	300-233-013

Ersatzhülse A

Ø 5.5mm	300-233-255
Ø 11.0mm	300-233-211
Ø 13.0mm	300-233-213



Komplett mit Gewinde Synthetikhülse,
105mm Arbeitslänge A+B

Ø 5.5mm	300-234-055
Ø 11.0mm	300-234-011
Ø 13.0mm	300-234-013

Ersatzhülse A

Ø 5.5mm	300-234-255
Ø 11.0mm	300-234-211
Ø 13.0mm	300-234-213

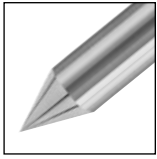

**Standard Trokar, wiederverwendbar,
konisch, schneidende Spitze**

Ø 3.5mm	300-240-035
Ø 5.5mm	300-240-055
Ø 11.0mm	300-240-011
Ø 13.0mm	300-240-013
Ø 15.0mm	300-240-015
Ø 20.0mm	300-240-020

XL Trokar, 150mm Arbeitslänge

Ø 5.5mm	300-241-155
---------	-------------

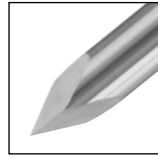
**Standard Trokar, wiederverwendbar,
pyramidenförmig, schneidende Spitze**

Ø 3.5mm	300-241-035
Ø 5.5mm	300-241-055
Ø 11.0mm	300-241-011
Ø 13.0mm	300-241-013
Ø 15.0mm	300-241-015
Ø 20.0mm	300-241-020

Trokar, 70mm Arbeitslänge

Ø 5.5mm	300-239-750
---------	-------------

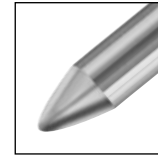
**Hasson Trokar, wiederverwendbar,
atraumatische, stumpfe Ball-Spitze**

Ø 3.5mm	300-242-035
Ø 5.5mm	300-242-055

Trokar, 70mm Arbeitslänge

Ø 5.5mm	300-239-755
---------	-------------

**Sicherheits-Trokar System
160mm Arbeitslänge**

Ø 5.5mm	300-152-055
---------	-------------

170mm Arbeitslänge

Ø 11.0mm	300-152-011
Ø 12.5mm	300-152-012



Geschützte Trokarspitze



Scharfe Trokarspitze

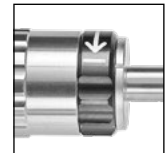

Sicherheitsmechanismus

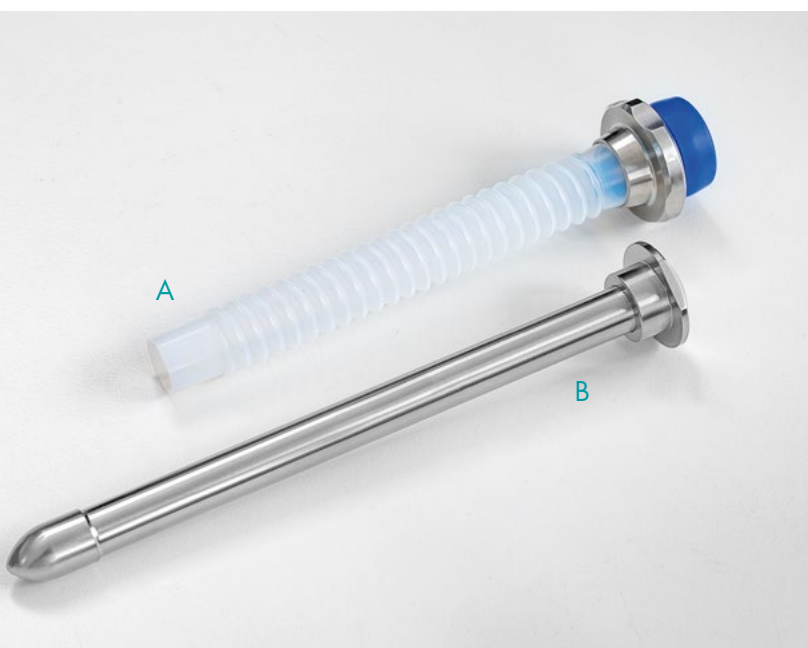
**Flexibles Thorax Trokar System
100mm Arbeitslänge A+B**

Ø 5.5mm	●	300-020-255
Ø 11.0mm	●	300-020-211

Obturator B

Ø 5.5mm	300-023-255
Ø 11.0mm	300-023-711

**Flexibles Thorax Trokar System
70mm Arbeitslänge A+B**

Ø 5.5mm	●	300-020-755
Ø 11.0mm	●	300-020-711

Obturator B

Ø 5.5mm	300-023-755
Ø 11.0mm	300-023-711



Verschlusskappe, 10 Stück

für Ø 3.5mm	●	300-250-035
für Ø 5.5mm	●	300-250-055
für Ø 11.0mm	●	300-250-011
für Ø 13.0mm	●	300-250-013



Dichtung für Multiport, 10 Stück

für Ø 3.5mm	●	300-250-235
für Ø 5.5mm	●	300-250-255
für Ø 11.0mm	●	300-250-211
für Ø 13.0mm	●	300-250-213
für Ø 15.0mm	●	300-250-215
für Ø 20.0mm	●	300-250-220

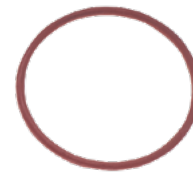

Dichtung für Multiport, 10 Stück

für Ø 3.5mm	300-250-135
für Ø 5.5mm	300-250-135
für Ø 11.0mm	300-250-111
für Ø 13.0mm	300-250-111



Reduzierhülse, 60mm

Ø 10mm → 5.0 mm	300-012-106
Ø 11mm → 5.5 mm	300-012-116
Ø 12.5mm → 5.5 mm	300-012-121



Reduzierclip mit Silikonband

Ø 11mm → 5.5mm	300-021-011
Ø 12.5mm → 5.5mm	300-021-125



Reduzierclip mit Silikonband

Ø 11mm → 5.5mm	300-021-355
Ø 13mm → 5.5mm	300-021-305
Ø 13mm → 10.0mm	300-021-310



Veress Insufflationsnadel, Ø 2.0mm

100mm Arbeitslänge	300-195-100
120mm Arbeitslänge	300-195-120
150mm Arbeitslänge	300-195-150
170mm Arbeitslänge	300-195-170
200mm Arbeitslänge	300-195-200

Ringgriff Instrumente

- Wiederverwendbare, 3-teilige Instrumente
- Ergonomisches Design
- Austauschbare Einsätze
- Modulares, kostensparendes System



PEEK Polymer Griff
mit HF Anschluss

300-750-101



PEEK Polymer Griff mit Sperre
und HF Anschluss

300-750-103



PEEK Polymer Griff mit zuschlatbarer Sperre
und HF Anschluss

300-750-105



PEEK Polymer Griff mit swing-away Sperre
und HF Anschluss

300-750-106



Metall Griff mit Sperre

300-750-020



Axial Griff mit Verriegelung, ein vergoldeter Ring

300-750-115



Aussenschaft, isoliert, 330mm

∅ 5mm 300-660-005

∅ 10mm 300-660-010



Maryland Dissektor, extra fein,
leicht gebogen, doppelbeweglich,
∅ 5mm



Einsatz allein

300-400-731



Komplettes Instrument mit Schaft
und Griff 300-750-101

300-420-731



Präparier-Fasszange, fein gerieft,
rechts gewinkelt, doppelbeweglich,
∅ 5mm



Einsatz allein

300-400-735



Komplettes Instrument mit Schaft
und Griff 300-750-101

300-420-735



Overholt Präparierzange,
90° gewinkelt, doppelbeweglich,
Ø 10mm

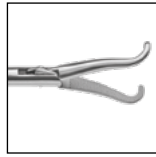

Einsatz allein

300-400-741



Komplettes Instrument mit Schaft
und Griff 300-750-101

300-420-741



Kelly Präparierzange, gebogen,
kreuzgerieft, doppelbeweglich,
Ø 5 mm



Einsatz allein

300-400-732



Komplettes Instrument mit Schaft
und Griff 300-750-101

300-420-732



Mixer Feine Präparierzange,
90° gewinkelt, fein gerieft,
doppelbeweglich, Ø 5 mm

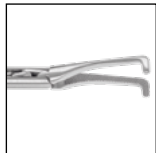

Einsatz allein

300-400-738



Komplettes Instrument mit Schaft
und Griff 300-750-101

300-420-738



DeBakey Pick-Up Zange, 38mm Maulteil,
22mm Riefung, doppelbeweglich,
Ø 5mm



Einsatz allein

300-400-243



Komplettes Instrument mit Schaft
und Griff 300-750-103

300-440-243



Komplettes Instrument mit Schaft
und Griff 300-750-105

300-470-243



DeBakey Fasszange, 25mm,
doppelbeweglich, Ø 5mm



Einsatz allein

300-400-244



Komplettes Instrument mit Schaft
und Griff 300-750-103

300-440-244



Komplettes Instrument mit Schaft
und Griff 300-750-105

300-470-244



Johans Fasszange,
20mm gefensterter Maul,
doppelbeweglich, Ø 5mm

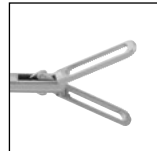

Einsatz allein

300-400-289



Komplettes Instrument mit Schaft
und Griff 300-750-103

300-440-289



Komplettes Instrument mit Schaft
und Griff 300-750-105

300-470-289



Babcock Paddel-Fasszange,
flache Paddel, doppelbeweglich,
Ø 5mm

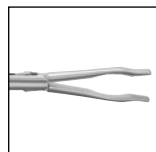

Einsatz allein

300-400-250



Komplettes Instrument mit Schaft
und Griff 300-750-103

300-440-250



Komplettes Instrument mit Schaft
und Griff 300-750-105

300-470-250



Babcock Fasszange,
einfach beweglich, Ø 5mm



Einsatz allein

300-400-251



Komplettes Instrument mit Schaft
und Griff 300-750-101

300-420-251



Babcock Faszange, gerundet,
fein gerieft, doppelbeweglich,
Ø 5mm

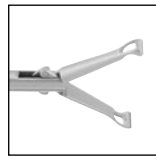

Einsatz allein

300-400-252



Komplettes Instrument mit Schaft
und Griff 300-750-103

300-440-252



Komplettes Instrument mit Schaft
und Griff 300-750-105

300-470-252



Faszange mit Biopsie Löffel,
schweres Modell, doppelbeweglich,
Ø 5mm



Einsatz allein

300-400-000



Komplettes Instrument mit Schaft
und Griff 300-750-103

300-440-000



Komplettes Instrument mit Schaft
und Griff 300-750-105

300-460-000



Bullnose Faszange, schweres Modell,
doppelbeweglich,
Ø 5mm



Einsatz allein

300-400-001



Komplettes Instrument mit Schaft
und Griff 300-750-103

300-440-001



Komplettes Instrument mit Schaft
und Griff 300-750-105

300-460-001

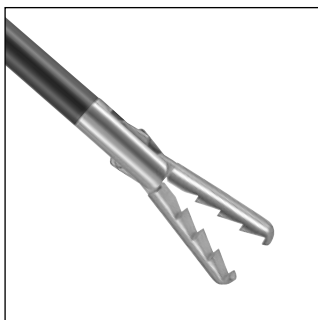

Alligator Faszange,
kräftige, retrograde Zähne,
doppelbeweglich,, Ø 5mm

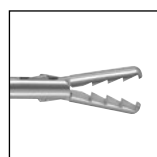

Einsatz allein

300-400-010



Komplettes Instrument mit Schaft
und Griff 300-750-103

300-440-010



Komplettes Instrument mit Schaft
und Griff 300-750-105

300-460-010



Shark Fasszange, sehr scharf, aggressive laterale, retrograde Zähne, doppelbeweglich, Ø 5mm

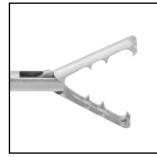

Einsatz allein

300-400-048



Komplettes Instrument mit Schaft und Griff 300-750-103

300-440-048



Komplettes Instrument mit Schaft und Griff 300-750-105

300-460-048



Biopsiezange, 2 Nadellöcher, scharfe, ovale Löffel, doppelbeweglich, Ø 5mm



Einsatz allein

300-400-080



Komplettes Instrument mit Schaft und Griff 300-750-101

300-420-080



Martin Fasszange, mehrfach gezahnt, 4.8 mm breites Maulteil, einfach beweglich, Ø 5mm



Einsatz allein

300-400-011



Komplettes Instrument mit Schaft und Griff 300-750-105

300-460-011



Martin Fasszange, mehrfach gezahnt, 4.8 mm breites Maulteil, einfach beweglich, Ø 5mm



Einsatz allein

300-400-011



Komplettes Instrument mit Schaft und Griff 300-750-103

300-440-011

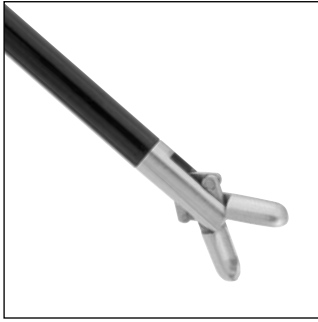

Biopsiezange, scharfe, ovale Löffel,
doppelbeweglich,
Ø 5mm

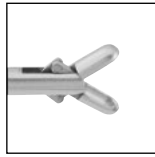

Einsatz allein

300-400-082



Komplettes Instrument mit Schaft
und Griff 300-750-101

300-420-082



Hakenschere, runde Schneidblätter,
einfach beweglich,
Ø 5mm



Einsatz allein

300-400-060



Komplettes Instrument mit Schaft
und Griff 300-750-101

300-420-060



Metzenbaum Schere, 12mm kurze Blätter,
leicht gebogen, doppelbeweglich,
Ø 5mm

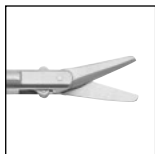

Einsatz allein

300-400-067



Komplettes Instrument mit Schaft
und Griff 300-750-101

300-420-067



Metzenbaum Schere, 15mm medium
Blätter, gerade, doppelbeweglich,
Ø 5mm

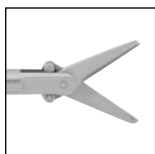

Einsatz allein

300-400-068



Komplettes Instrument mit Schaft
und Griff 300-750-101

300-420-068



Metzenbaum Schere, 12mm kurze
Blätter, gerade, doppelbeweglich,
Ø 5mm

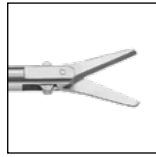

Einsatz allein

300-400-069



Komplettes Instrument mit Schaft
und Griff 300-750-101

300-420-069



Metzenbaum Schere, 15mm lange Blätter,
leicht gebogen, doppelbeweglich,
Ø 5mm



Einsatz allein

300-400-070



Komplettes Instrument mit Schaft
und Griff 300-750-101

300-420-070

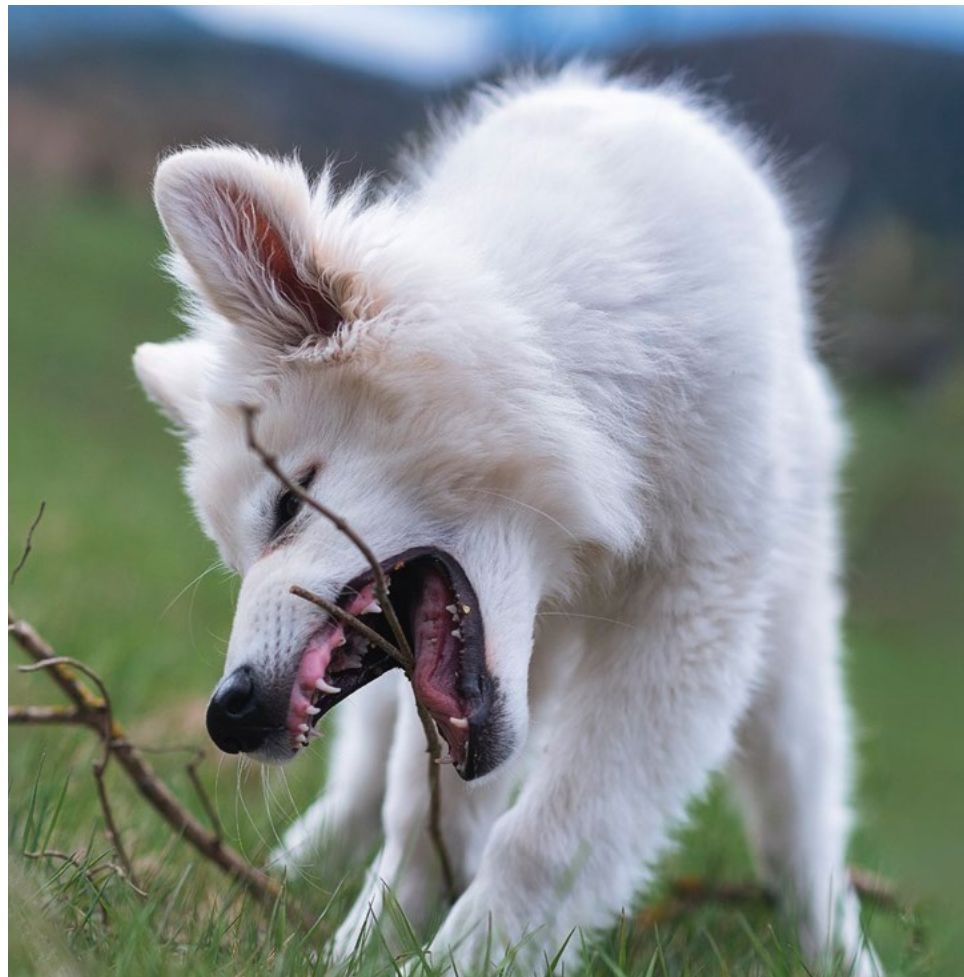



Zerlegbare, bipolare Zangen

- 360° rotierbar
- Bestehend aus Zangenkörper und Schaft - ohne Elektrode

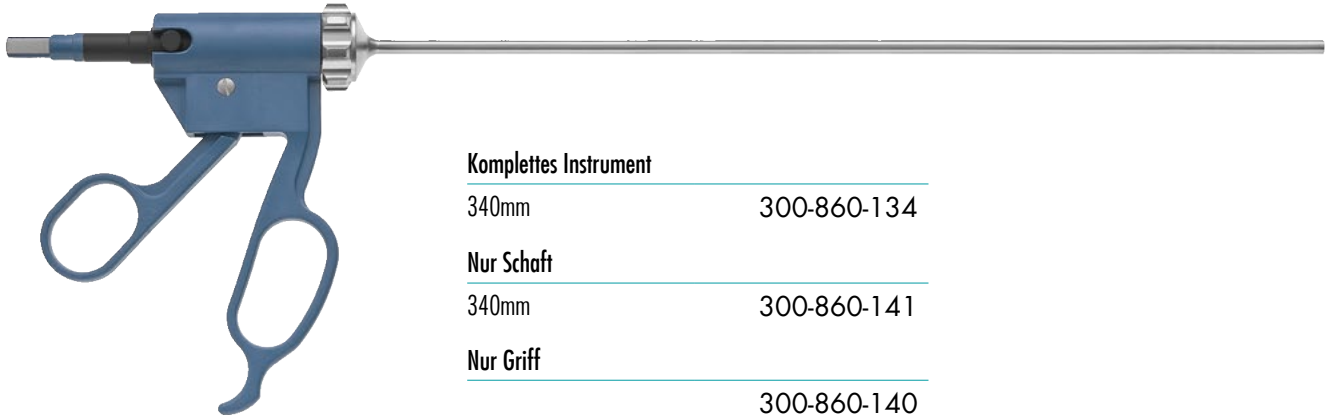

Komplettes Instrument

340mm 300-860-134

Nur Schaft

340mm 300-860-141

Nur Griff

300-860-140

Bipolare Elektrodeneinsätze



Duckbill Zange

Ø 5mm

300-860-016

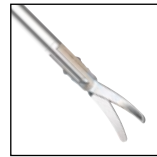

TC Metzenbaum Schere

Ø 5mm

300-860-018

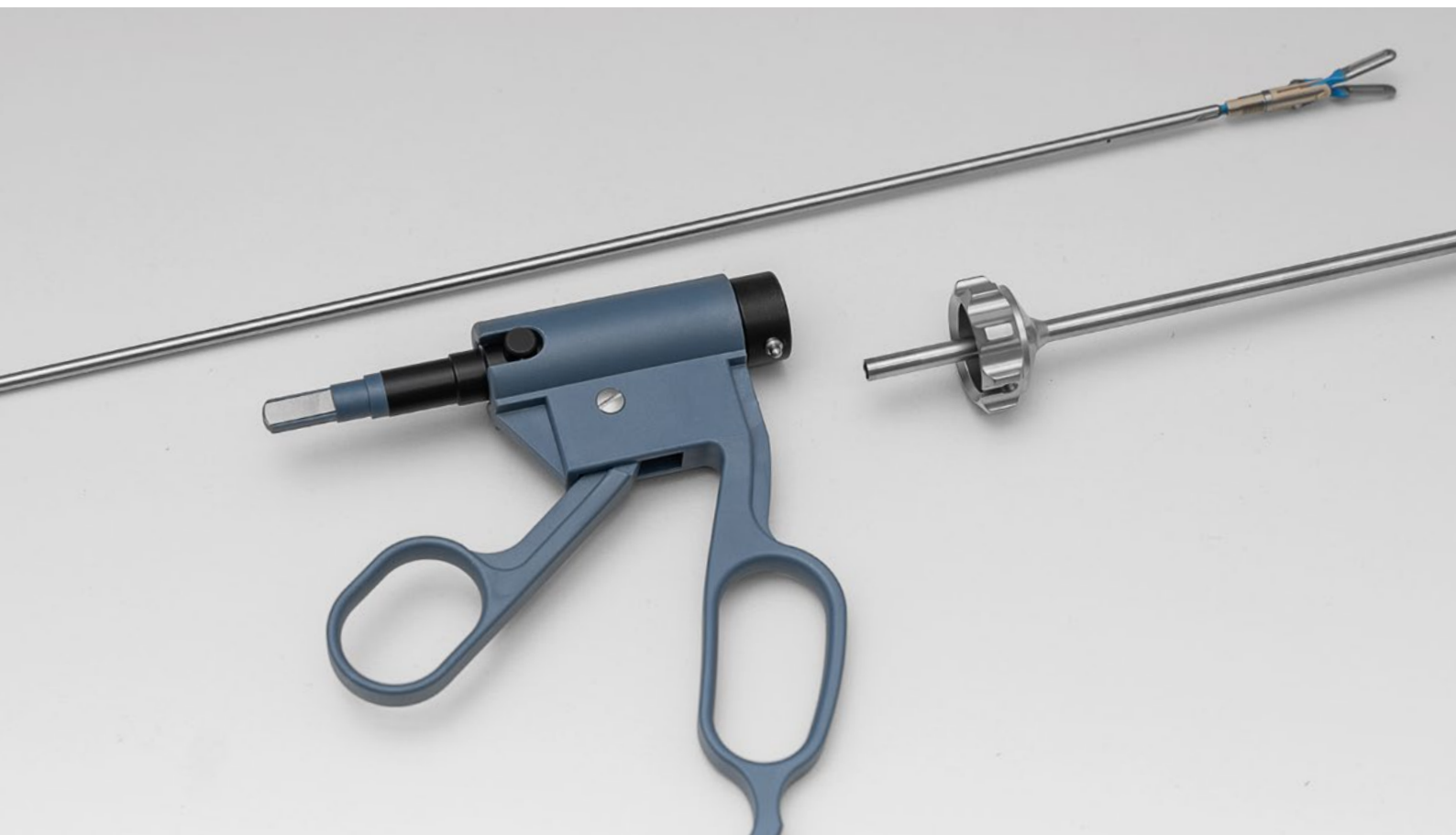

Instrumente

**Tastsonde, graduiert, 330mm Arbeitslänge**

∅ 2.8mm	300-193-303
---------	-------------

300mm Arbeitslänge

∅ 5.0mm	300-193-305
---------	-------------

330mm Arbeitslänge

∅ 5.0mm	300-193-335
---------	-------------

400mm Arbeitslänge

∅ 5.0mm	300-193-405
---------	-------------

∅ 10.0mm	300-193-410
----------	-------------

**Knotenschieber, geschlossen, 330mm Arbeitslänge**

∅ 4mm	300-030-004
-------	-------------

**Führungsrohr für Cholangiografie-Katheter, 330mm Arbeitslänge**

∅ 5mm	300-193-330
-------	-------------

**Endo-Dilatationsspekulum**

195mm

300-023-100



Endoskopischer Nadelhalter

- Einteiliges Instrument
- Ergonomisch und äußerst leicht (120g)
- Aluminium-anodisierter Griff
- Korrosionsschutz



Leichtgewichtiges Design mit satinschwarzer Oberfläche



65° LuerLock Spülanschluss für optimalen Zugang



6-zahnige Sperre für eine gleichbleibende, optimale Positionierung, mit Überlastschutz



Gerade, TC Einsätze, Ø 5mm

330mm Arbeitslänge

300-300-130

450mm Arbeitslänge

300-300-230

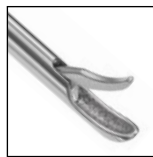

Konkav/Konvex, diamantbeschichtetes Maul, 330mm Arbeitslänge

Ø 5mm

300-300-142



Fächerretraktor & Bandpasser

- Spülanschluss-System
- Vertikale Justierung bis max. 50°

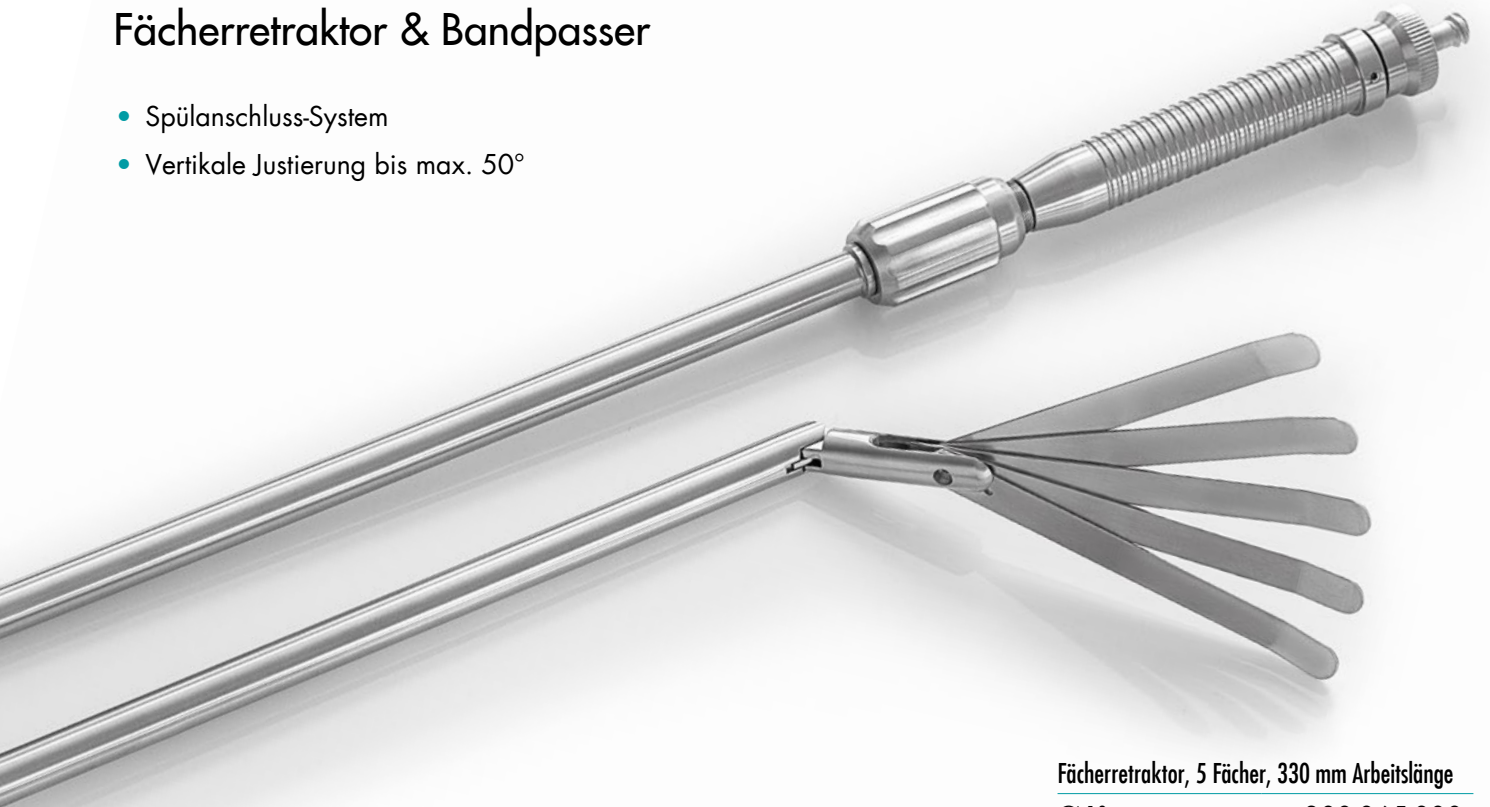

Fächerretraktor, 5 Fächer, 330 mm Arbeitslänge

Ø 10mm

300-065-000

- Einfach verwendbar mit 5.0 / 5.5 Trokar Hülse
- Karbongriff
- Nitinoldraht

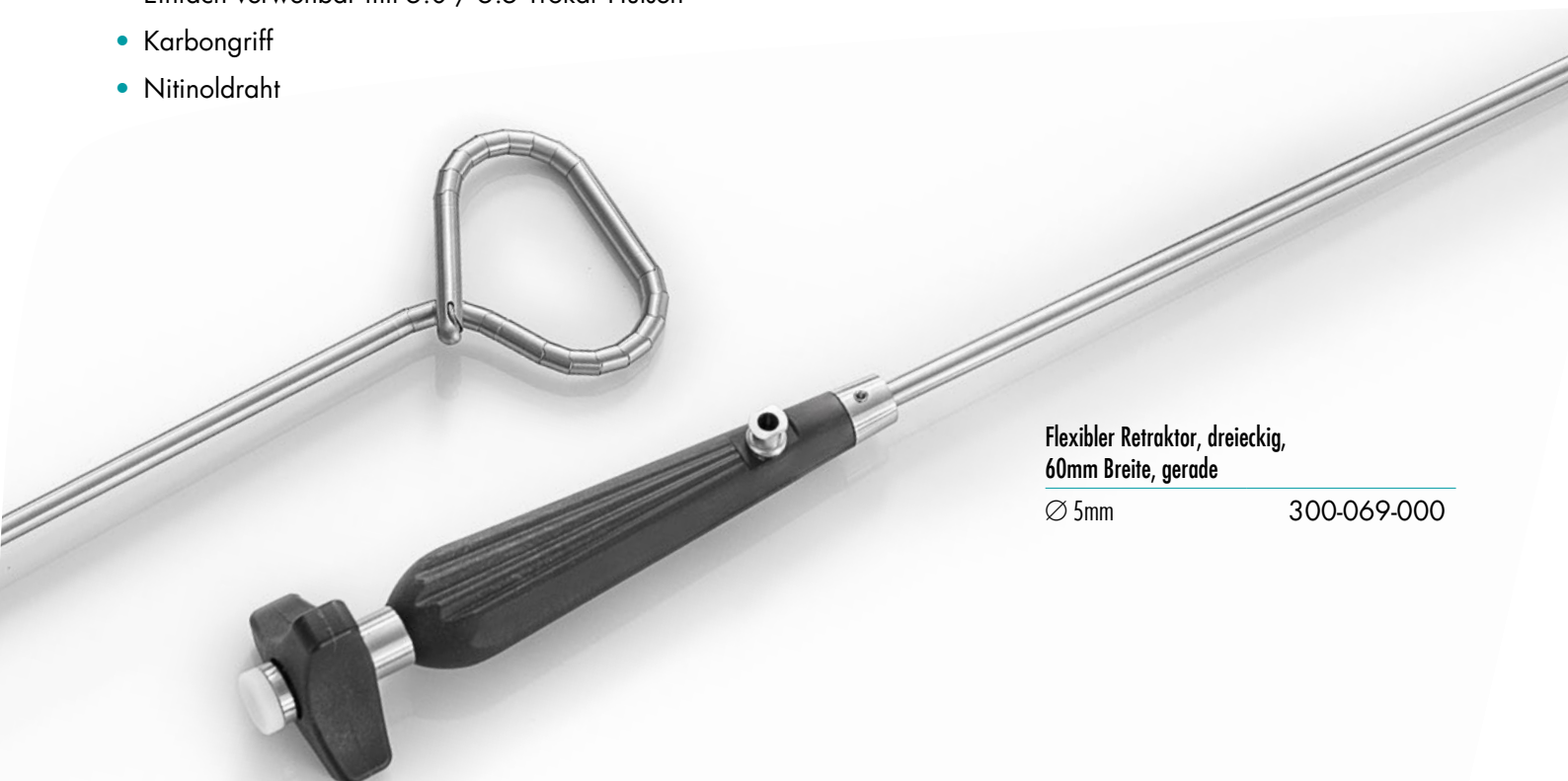

Flexibler Retraktor, dreieckig,
60mm Breite, gerade

Ø 5mm

300-069-000

Nathanson Leber Retraktor

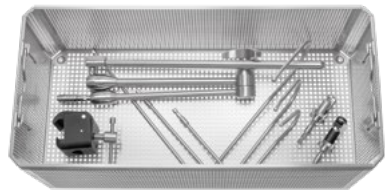
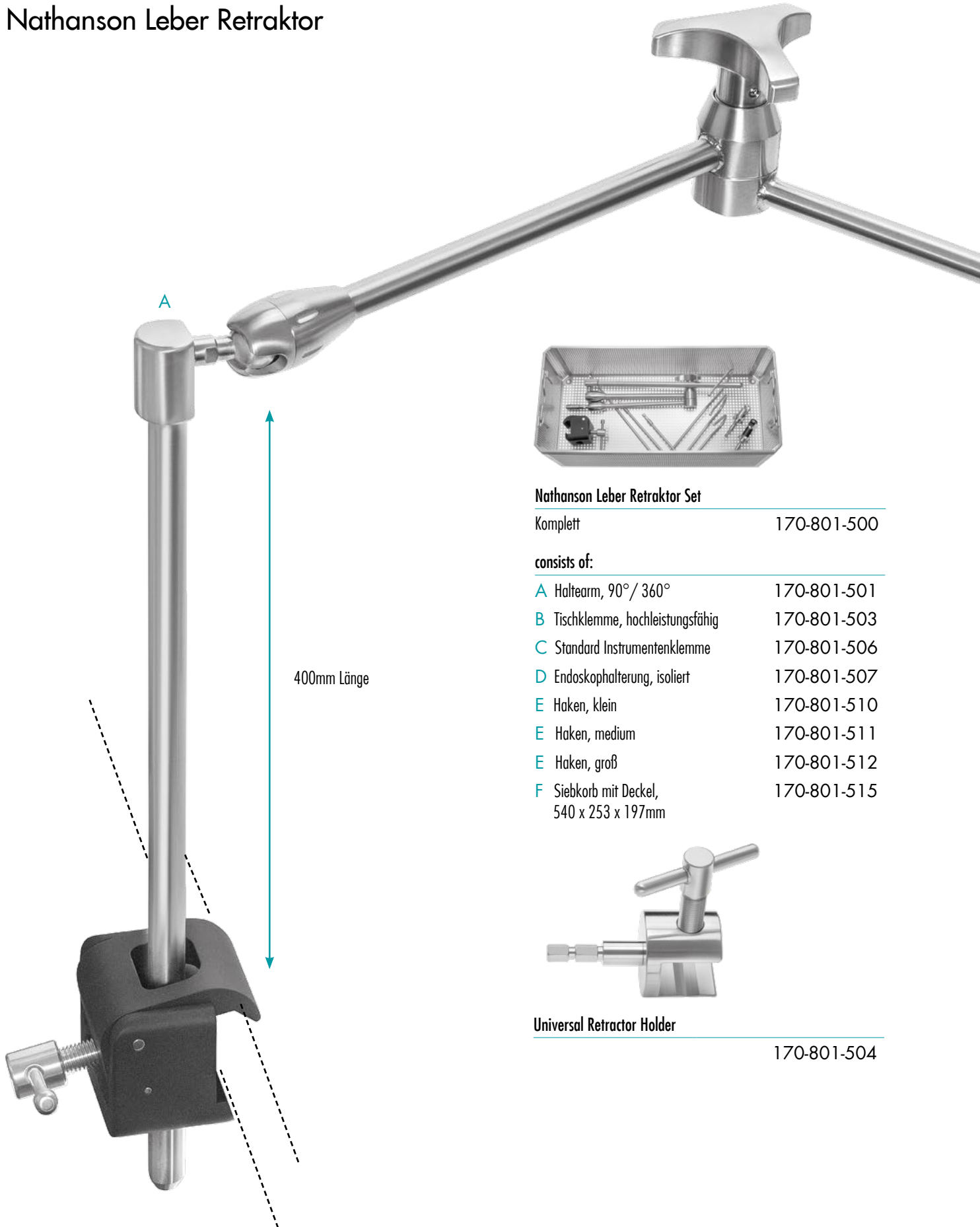

Nathanson Leber Retraktor Set

Komplett 170-801-500

consists of:

A Haltearm, 90° / 360°	170-801-501
B Tischklemme, hochleistungsfähig	170-801-503
C Standard Instrumentenklemme	170-801-506
D Endoskophalterung, isoliert	170-801-507
E Haken, klein	170-801-510
E Haken, medium	170-801-511
E Haken, groß	170-801-512
F Siebkorb mit Deckel, 540 x 253 x 197mm	170-801-515



Universal Retractor Holder

170-801-504

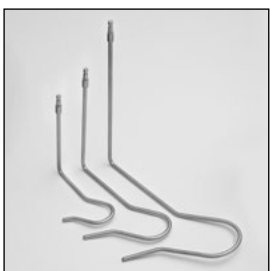
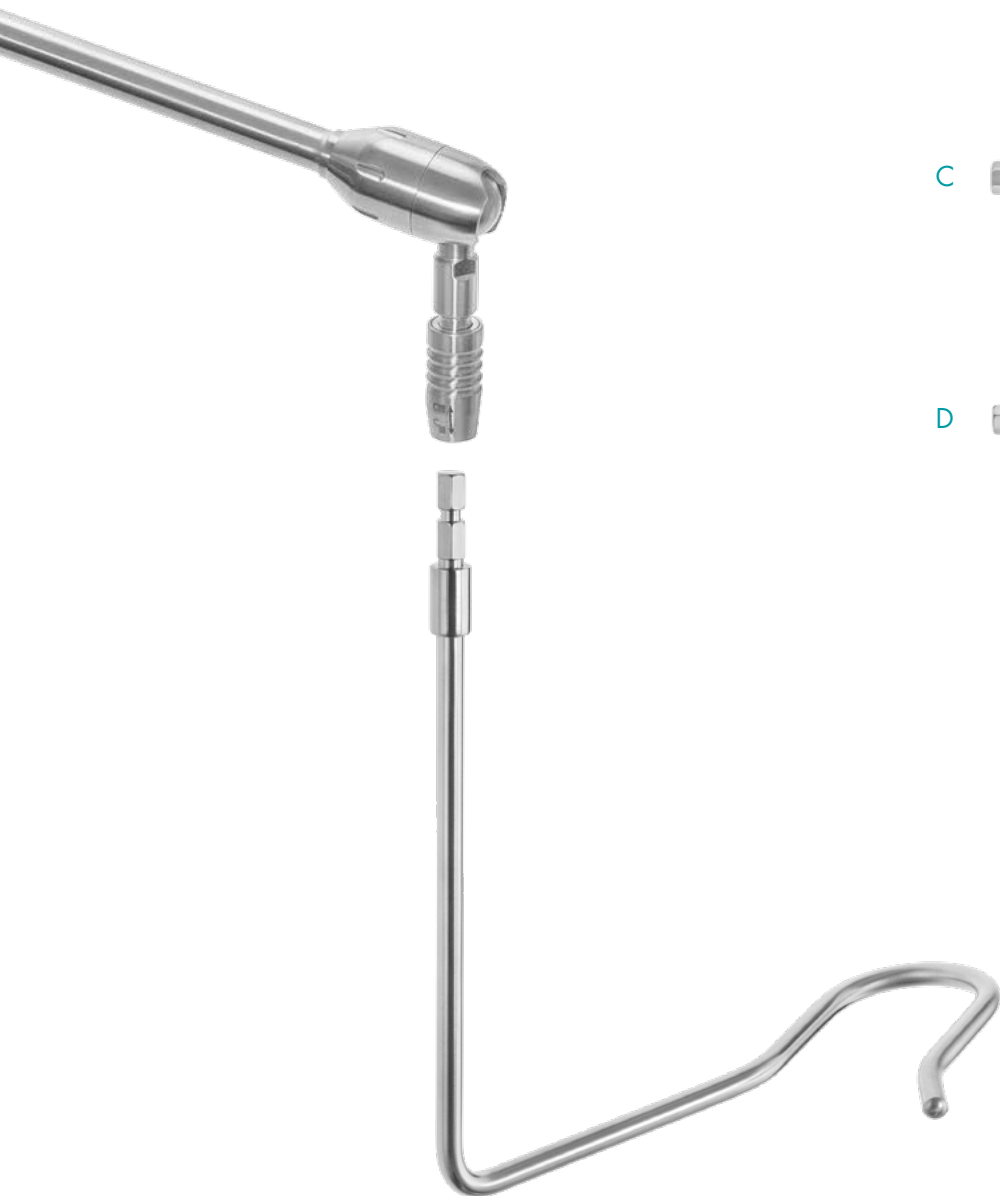

geräte.





Unser Komplettsystem für die endoskopische Chirurgie. Wir gehen auf Ihre individuellen Bedürfnisse ein und stellen Ihnen Möglichkeiten für Ihre persönliche Konfiguration zur Verfügung.



Universelles und flexibles „Rundum-sorglos-System“ für Diagnostik und die endoskopische Therapie. Das Komplettsystem lässt sich leicht transportieren, intuitiv einrichten und nutzen. Der ultrahochauflösende Monitor und die FullHD-Kamera erzeugen ein hochwertiges Bild und die 60Watt äquivalente Lichtquelle sorgt für eine gute Ausleuchtung.

- 4K HD 17,3" Bildschirm
- LED-Lichtquelle, 60W äquivalent
- Desinfizierbare FullHD-Kamera mit Zoom-Adapter
- Endoskopische Plattform mit Video- und Bildrekorder und Netzwerkanschluss
- Auflösung: 1920 x 1080

300-490-001

ALL IN ONE FULL HD SYSTEM

bestehend aus:

- A Kamerakopf, Full HD
- B TV-Adapter, f1.4 bis f3.5
- C Lichtleiterkabel mit Adapter
- D Laptop mit Software, LED Lichtquelle
- E Koffer



Die mobile, endoskopische Untersuchung wird mit dieser HD Kamera möglich. Integrierte Beleuchtung und ein leistungsstarker Kamerakopf, der über USB 3.0 mit Strom versorgt wird, ermöglichen Untersuchungen und minimalinvasive Eingriffe.

- Full HD (1920 x 1080) Aufnahmefunktion (Bilder/Video)
- Kompatibel mit allen USB 3.0 ports
- Langlebige LED Lichtquelle
- Programmierbare Bedienknöpfe am Kamerakopf
- Lichthelligkeit über Kamerakopf anpassbar
- Einfache Softwareinstallation und Bedienung (Software inkl. Patientenmanagement/-speicherung)
- Plug & Play

300-001-480

FULL HD CAMERA SET

bestehend aus:

- A Kamerakopf
- B TV-Adapter
- C Lichtquelle
- D Koffer
- E Software (Laptop nicht inklusive)





4K 3-Chip UHD Camera K 4000

300-001-840V

Features:

- 4K-UHD-Auflösung mit 3-Chip-Technologie
- Echte, natürliche Farben für herausragende Lebendigkeit in der chirurgischen Bildgebung
- Aufnahmefunktion (Video und Bild)
- Programmierbarer Kamerakopf mit 4 Drucktasten
- Boost-Funktion
- Zoom, Freeze, Nebelreduzierung uvm.
- 10 USER-Modi-Konfigurationen
- Mehrsprachiges Menü
- Textgenerator (optional mit Tastatur)



UHD Kamerakopf

(inklusive)

300-001-841

4K

**Ultra High Definition Quality
3840 x 2160 PIXELS**



Lieferumfang:

- Steuergerät (300-001-840V)
- Kamerakopf (300-001-841)
- HDMI Kabel
- USB Stick
- Anschlusskabel
- Bedienungsanleitung



Aufnahmefunktion mittels USB Stick



Kamerakopf mit 4 erhabenen Druckknöpfen



Vorteile:

- Pure Natural Colors-Technologie
- Umfangreiche, digitale Videoausgänge für bestmögliche Bildübertragung
- Ergonomischer Kamerakopf mit 3 programmierbaren Tasten zur Fernbedienung
- Benutzerfreundliches, mehrsprachiges Menü ermöglicht eine große Vielzahl von Setups für individuelle Programmierungen
- Full-HD-Videoaufzeichnung mit 60 fps
- Full-HD-Bildspeicherung
- Inklusive USB-Stick
- Textgenerator (optional mit Tastatur)

FULL HD
1-CHIP FULL HD
1920 x 1080
PIXELS



F2 Camera Head

(included)

300-001-602



Lieferumfang:

- Steuergerät
- Kamerakopf
- HDMI-DVI Kabel
- HDMI Kabel
- S-Video Kabel
- RGB Kabel
- BNC Kabel
- USB Stick
- Anschlusskabel
- Bedienungsanleitung

HD-Camera F2 Pro300-001-601V



3-Chip Camera F4

300-001-804V

Vorteile:

- Full HD-Kamera mit neuester 3-MOS-Technologie für brillante Bildqualität
- Pure Natural Colors-Technologie
- Vielzahl digitaler Videoausgänge für bestmögliche Bildübertragung auf medizinische Monitore
- Ergonomischer Kamerakopf mit 3 programmierbaren Tasten
- Benutzerfreundliches, mehrsprachiges Menü ermöglicht eine große Vielzahl von Setups für individuelle Programmierungen und Vorlieben des Operators
- Full-HD-Videoaufzeichnung mit 60 fps
- Full-HD-Bildspeicherung
- Inklusive USB-Stick
- Textgenerator (optional mit Tastatur)



Lieferumfang:

- Steuergerät
- Kamerakopf
- HDMI-DVI Kabel
- HDMI Kabel
- S-Video Kabel
- USB Stick
- Anschlusskabel
- Bedienungsanleitung



3-MOS Kamerakopf
(inklusive)

300-001-802



TV Adapter für SPiTZ Kameras



**TV Adapter, manueller Verschluss, C-mount,
wasserdicht, FULL HD**

f=14mm	300-001-813
f=25mm	300-001-814
f=28mm	300-001-815



**Zoom TV Adapter, C-mount,
wasserdicht, FULL HD**

f=15 - 36mm	250-015-036
-------------	-------------



LUMEN LED 1 Lichtquelle

300-900-180V



Manuelle oder automatische Lichtstärkeregelung

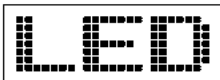

Vorteile:

- Tageslicht-Qualität
- >20.000h Lebensdauer der Lampe
- Manuelle oder automatische Lichtstärkeregelung
- Wenig Hitzeemission durch moderne LED Technologie

Lieferumfang:

- Steuergerät
- BNC Kabel
- Anschlusskabel
- Bedienungsanleitung



Digitales Lichtstärke Display

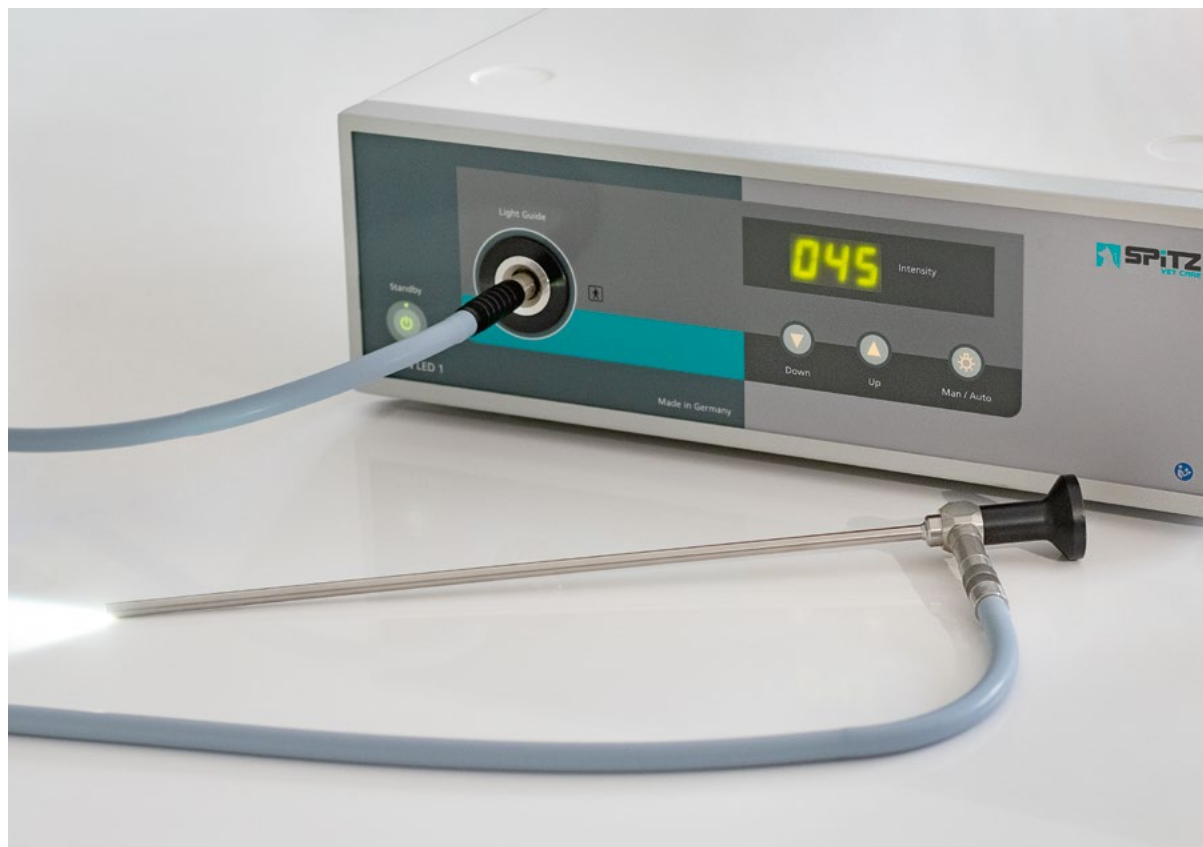



Lichtleiterkabel, ohne Adapterstücke

∅ 2.5mm, 2300mm	250-025-230
∅ 2.5mm, 3000mm	250-025-300
∅ 3.5mm, 1800mm	250-035-180
∅ 3.5mm, 2300mm	250-035-230
∅ 3.5mm, 3000mm	250-035-300
∅ 4.8mm, 1800mm	250-048-130
∅ 4.8mm, 2300mm	250-048-230
∅ 4.8mm, 3000mm	250-048-300



A



B



C



D



I



E



F



J



G



H



K



**Adapterstücke für Lichtleiterkabel,
zur Verwendung an der Lichtquelle**

A SPiTZ/Storz	250-039-000
B Wolf	250-037-000
C ACMI/British Standard/CUDA	250-041-000
D Olympus	250-044-000
E Luxtec	250-048-000
F Heine	250-052-000
G Stryker	250-051-000
H Pentax	250-059-000



**Adapterstücke für Lichtleiterkabel,
zur Verwendung am Endoskop**

I SPiTZ/Storz/Olympus	250-042-000
J Wolf	250-040-000
K ACMI/British Standard	250-041-000



LAP Suction and Irrigation Pump P1000
Saug- und Spülpumpe, komplettes Set

300-000-100V



Spezielle Filter
gewährleisten die
Sterilität



Digitales Display zeigt
den aktuellen Saug- und
Spüldruck

Vorteile:

- Unabhängige, digitale Voreinstellung für maximalen Saug- und Spüldruck
- Digitale Anzeige der tatsächlichen Saugleistung und Bewässerungsdruck
- Hohe Effizienz mit Raten von bis zu 3 l/Minute
- Farbcodierte Schlauchsets
- Niedriger Geräuschpegel
- Optionaler Fußschalter

Lieferumfang:

- Steuergerät
- Saug- und Spül Schlauchset
- Absaugungsflasche, 2L
- 2 Halter mit Schrauben
- Durchstechrohr, 235mm
- 2 wasserabweisende Filter, steril
- Anschlusskabel
- 2 Ersatz-Sicherungen
- Bedienungsanleitung



Pumpe P1, 110 - 230V

Für Arthroskopie	225-906-000V
Spülschlauchset, Silikon, autoklavierbar (inklusive)	225-910-001
Spülschlauchset, PVC, 20 Stück, Tagesschlauch, steril (optional)	225-910-002
Patientenschlauch, PVC, 40 Stück, steril (optional)	225-910-003

Vorteile:

- Hydrostatische Druckregulierung
- Inklusive Silikonschlauchset (225-910-001)
- Einfach zu bedienendes, spritzwassergeschütztes Display

Lieferumfang:

- Steuergerät
- Schlauchset
- Anschlusskabel
- 2 Ersatz-Sicherungen
- Bedienungsanleitung





Airflow A2 Insufflator

Vorteile:

- Benutzerfreundliches Display
- Höchster Sicherheitsstandard für den Patienten
- Pre-insufflations Modus für die Verwendung von Veress Kanülen
- Hohe Gasfluss Geschwindigkeiten
- 20l/min.

Lieferumfang:

- Steuergerät
- Steriler Filter 300-902-007
- Schraubenschlüssel-Set 300-902-006
- CO₂ Hochdruckschlauch 300-902-003
- Standard Silikonschlauch 300-902-005
- Anschlusskabel
- Bedienungsanleitung



Airflow A2

300-900-020V





Steriler Filter

300-902-007



Schraubenschlüssel Set (SW30/SW17)

300-902-006



CO₂ Hochdruckschlauch

300-902-003



Standard Silikonschlauch

300-902-005



CO₂ Flasche, 0.75kg, leer (optional erhältlich)

300-902-008

Arthroskopie Shaver System STUNNER S1



Vorteile:

- 9 Oszillationsmodi
- Steuerbar über Tasten auf dem Handstück oder dem Fußschalter
- Ergonomisches Handstück, komplett autoklavierbar
- Passende Shaver Klingen
- Open window Funktion
- OSC bis 3500 U/min.

STUNNER S1 Steuergerät,
komplett mit Handstück und Fußschalter
110 - 230V

227-001-110V

Steuergerät

227-001-101V

Handstück

227-001-102V

Fußschalter

227-001-103V



Shaver Klingen



**DR PitBull
Shaver Blades**
Die Universalklinge für
weiches oder hartes Gewebe



**DR WAVER Cutter
Shaver Blades**
Die perfekte Klinge für weiche
Geweberesektion

Unsteril, 85mm Arbeitslänge

Ø 3.0mm 227-016-013

130mm Arbeitslänge

Ø 3.0mm 227-016-113

Ø 4.0mm 227-016-114

Unsteril, 85mm Arbeitslänge

Ø 2.0mm 227-016-002

Ø 3.0mm 227-016-003

130mm Arbeitslänge

Ø 3.0mm 227-016-103

Ø 4.0mm 227-016-104





Lithotripter

Vorteile:

- Der kleinste Sondendurchmesser beträgt nur 0,6mm, was ein größeres Lumen gewährleistet
- Es können auch Zusatzinstrumente eingesetzt werden
- Sehr einfache Handhabung, alle Teile sind zu Reinigungszwecken leicht zu demontieren
- Kompatibel zu SPiTZ und anderen Instrumenten für die Therapie von Harnleiter-, Nieren- und Blasensteinen
- Nicht-leitendes Handstück zur Gewährleistung der Sicherheit für Patienten und Anwender gegen Stromschlag



Lithotriptor L100

253-750-100V





Litho Sonde, 605mm Arbeitslänge

0.6mm	253-850-006
0.8mm	253-850-005
1.0mm	253-850-010
1.6mm	253-850-016
2.0mm, 450mm WL	253-850-020
2.5mm, 450mm WL	253-850-025



Fußschalter

253-750-150



Handstück, anodisiert

253-750-200



Luftkompressor, 4 bar maximum

(optional) 253-750-010



Lieferumfang:

- Steuergerät
- Anschlusskabel
- Bedienungsanleitung

Medizinische Monitore



**27" TFT Monitor mit LED
Hintergrundbeleuchtung, schwenkbar
1920 x 1800 pixel
HDMI, DP & VGA**

300-001-161



**24" TFT Monitor mit Verglasung
1920 x 1800 pixel
HDMI, DVI, VGA & Display Port**

300-001-162

Rollwägen

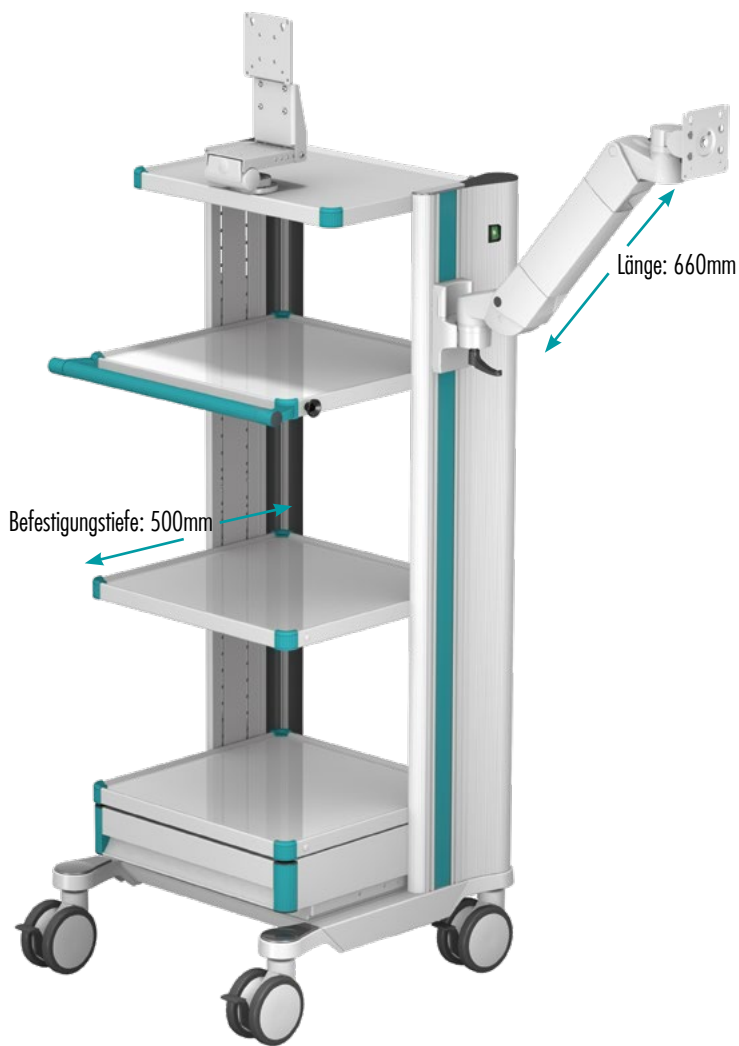

**INDIVIDUELLE
KONFIGURATION
MÖGLICH**



High-End Rollwagen

300-002-001

ABMESSUNGEN:
1600 x 500 x 625mm
Räder: Ø 125mm



Basic Rollwagen

300-001-999

