

SCISSORS



Surgical Scissors
Dissecting Scissors
Bandage and Cloth Scissors
Plaster Scissors
Wire Scissors
Suture Scissors
Ligature Scissors
Orthopaedics Scissors
Neuro Scissors
Vascular Scissors
Vessel Scissors
Eye Scissors
Tenotomy Scissors
ENT Scissors
Plastic Scissors
Gynecology Scissors
Supercut Scissors
Tungsten Carbide TC Scissors
CeraCut® Scissors



Fig. 1



Fig. 2



Fig. 3

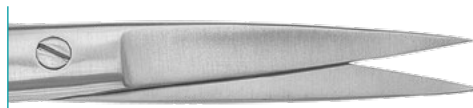

STANDARD

Fig. 1 (blunt/blunt), straight

115mm, 4 ¹ / ₂ "	120-010-115
130mm, 5 ¹ / ₈ "	120-010-130
145mm, 5 ³ / ₄ "	120-010-145
155mm, 6 ¹ / ₈ "	120-010-155
165mm, 6 ¹ / ₂ "	120-010-165
175mm, 6 ⁷ / ₈ "	120-010-175
185mm, 7 ¹ / ₄ "	120-010-185
200mm, 8"	120-010-200
curved	
115mm, 4 ¹ / ₂ "	120-011-115
130mm, 5 ¹ / ₈ "	120-011-130
145mm, 5 ³ / ₄ "	120-011-145
155mm, 6 ¹ / ₈ "	120-011-155
165mm, 6 ¹ / ₂ "	120-011-165
175mm, 6 ⁷ / ₈ "	120-011-175
185mm, 7 ¹ / ₄ "	120-011-185
200mm, 8"	120-011-200

Fig. 2 (sharp/blunt), straight

115mm, 4 ¹ / ₂ "	120-012-115
130mm, 5 ¹ / ₈ "	120-012-130
145mm, 5 ³ / ₄ "	120-012-145
155mm, 6 ¹ / ₈ "	120-012-155
165mm, 6 ¹ / ₂ "	120-012-165
175mm, 6 ⁷ / ₈ "	120-012-175
185mm, 7 ¹ / ₄ "	120-012-185
200mm, 8"	120-012-200
curved	
115mm, 4 ¹ / ₂ "	120-013-115
130mm, 5 ¹ / ₈ "	120-013-130
145mm, 5 ³ / ₄ "	120-013-145
155mm, 6 ¹ / ₈ "	120-013-155
165mm, 6 ¹ / ₂ "	120-013-165
175mm, 6 ⁷ / ₈ "	120-013-175
185mm, 7 ¹ / ₄ "	120-013-185
200mm, 8"	120-013-200

Fig. 3 (sharp/sharp), straight

115mm, 4 ¹ / ₂ "	120-014-115
130mm, 5 ¹ / ₈ "	120-014-130
145mm, 5 ³ / ₄ "	120-014-145
155mm, 6 ¹ / ₈ "	120-014-155
165mm, 6 ¹ / ₂ "	120-014-165
curved	
115mm, 4 ¹ / ₂ "	120-015-115
130mm, 5 ¹ / ₈ "	120-015-130
145mm, 5 ³ / ₄ "	120-015-145
155mm, 6 ¹ / ₈ "	120-015-155
165mm, 6 ¹ / ₂ "	120-015-165

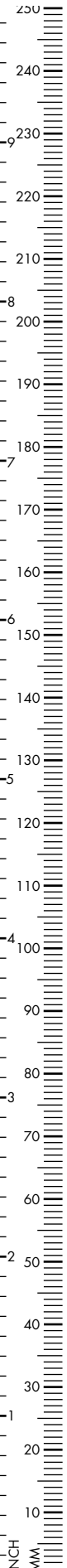

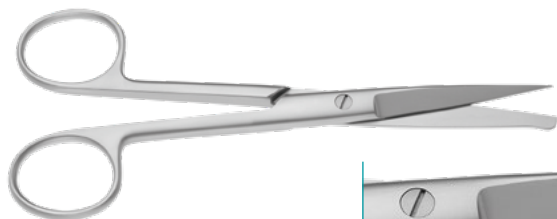

GRAZIL

straight, blunt/blunt

130mm, 5¹/₈" 120-016-130

145mm, 5³/₄" 120-016-145

curved

130mm, 5¹/₈" 120-017-130

145mm, 5³/₄" 120-017-145

straight, sharp/blunt

130mm, 5¹/₈" 120-018-130

145mm, 5³/₄" 120-018-145

curved

130mm, 5¹/₈" 120-019-130

145mm, 5³/₄" 120-019-145

straight, sharp/sharp

130mm, 5¹/₈" 120-020-130

145mm, 5³/₄" 120-020-145

curved

130mm, 5¹/₈" 120-021-130

145mm, 5³/₄" 120-021-145

Incision Scissors, straight

130mm, 5¹/₈" 120-022-130

145mm, 5³/₄" 120-022-145

DEAVER

straight, 120mm 4³/₄"

blunt/blunt 120-026-120

blunt/sharp 120-024-120

sharp/sharp 120-028-120

curved, 120mm 4³/₄"

blunt/blunt 120-027-120

blunt/sharp 120-025-120

sharp/sharp 120-029-120

145mm, 5³/₄", sharp/blunt

straight 120-024-145

curved 120-025-145

145mm, 5³/₄"

straight, blunt/blunt 120-026-145

curved, blunt/blunt 120-027-145

straight, sharp/sharp 120-028-145

curved, sharp/sharp 120-029-145



MAYO

straight

145mm, 5 ³ / ₄ "	120-030-145
150mm, 6"	120-030-150
170mm, 6 ² / ₃ "	120-030-170

curved

145mm, 5 ³ / ₄ "	120-031-145
150mm, 6"	120-031-150
170mm, 6 ² / ₃ "	120-031-170



MAYO STILLE

straight

150mm, 6"	120-036-150
170mm, 6 ² / ₃ "	120-036-170
195mm, 7 ³ / ₄ "	120-036-195
210mm, 8 ¹ / ₄ "	120-036-210

curved

150mm, 6"	120-037-150
170mm, 6 ² / ₃ "	120-037-170
195mm, 7 ³ / ₄ "	120-037-195
210mm, 8 ¹ / ₄ "	120-037-210

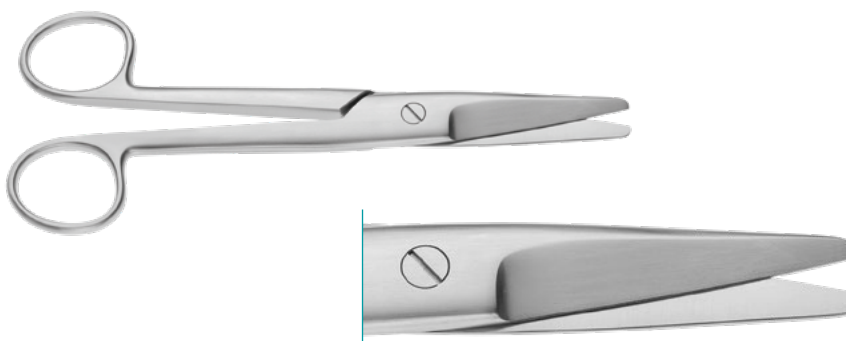

MAYO NOBLE

straight

170mm, 6 ² / ₃ "	120-048-170
--	-------------

curved

170mm, 6 ² / ₃ "	120-049-170
190mm, 7 ¹ / ₂ "	120-049-190

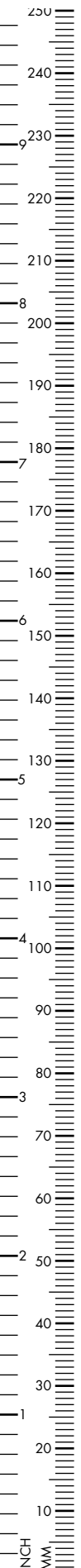



LEXER BABY

Dissecting Scissors, blunt/blunt, 105mm, 4¹/₈"

straight	120-136-100
curved	120-137-100



LEXER

Dissecting Scissors, 160mm, 6¹/₄"

straight	120-126-160
curved	120-127-160

210mm, 8¹/₄"

straight	120-126-210
curved	120-127-210



MAYO HARRINGTON

Dissecting Scissors, straight

230mm, 9"	120-030-230
280mm, 11"	120-030-280

curved

230mm, 9"	120-031-230
280mm, 11"	120-031-280

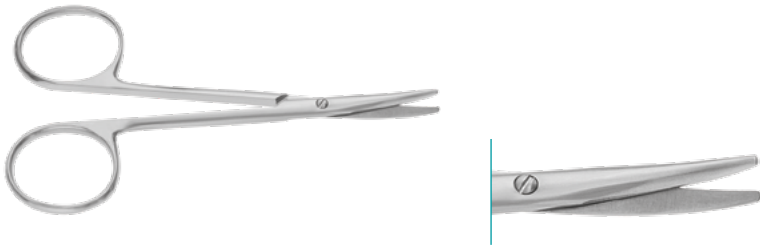

BABY METZENBAUM

straight

115mm, 4 ¹ / ₂ "	120-110-115
--	-------------

curved

115mm, 4 ¹ / ₂ "	120-111-115
--	-------------



METZENBAUM

straight

145mm, 5 ³ / ₄ "	120-110-145
--	-------------

160mm, 6 ¹ / ₄ "	120-110-160
--	-------------

curved

145mm, 5 ³ / ₄ "	120-111-145
--	-------------

160mm, 6 ¹ / ₄ "	120-111-160
--	-------------

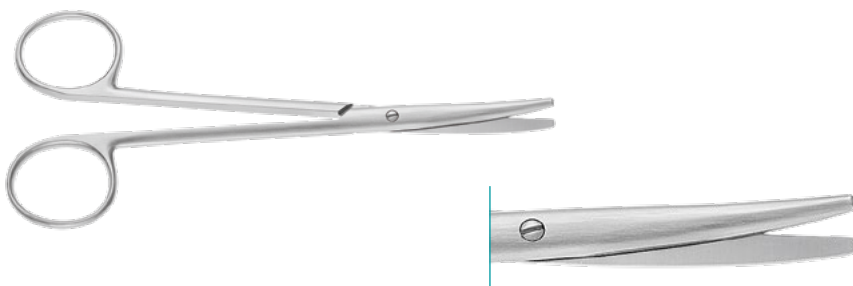

METZENBAUM LAHEY

curved

145mm, 5 ³ / ₄ "	120-330-145
--	-------------

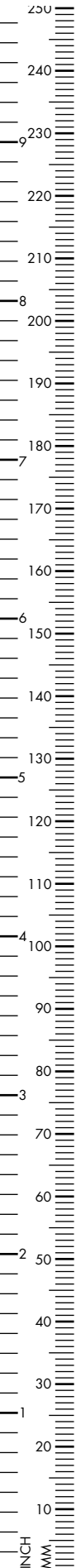

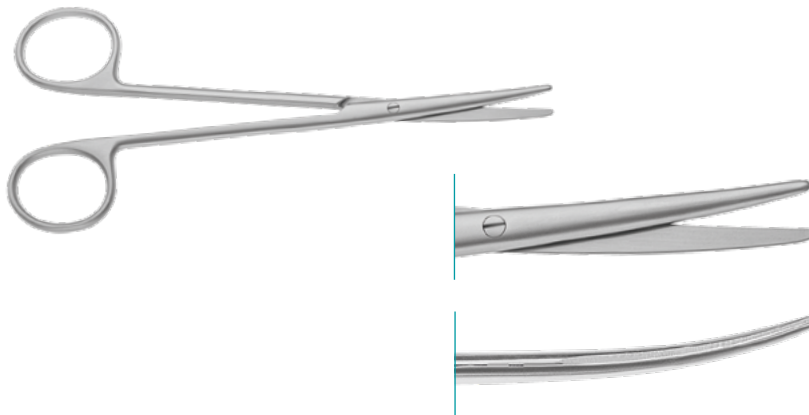

METZENBAUM FINO

straight

145mm, 5 ³ / ₄ "	120-152-145
180mm, 7"	120-152-180
200mm, 8"	120-152-200
230mm, 9"	120-152-230

curved

145mm, 5 ³ / ₄ "	120-153-145
180mm, 7"	120-153-180
200mm, 8"	120-153-200
230mm, 9"	120-153-230

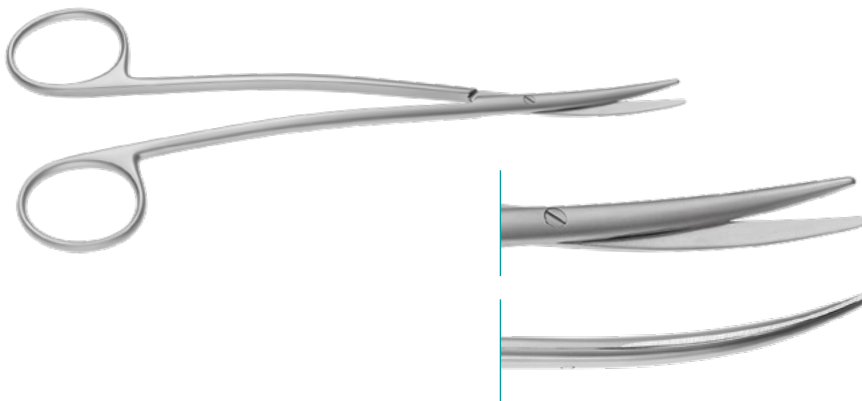

METZENBAUM FINO

s-shaped, blunt

180mm, 7"	120-157-180
200mm, 8"	120-157-200
230mm, 9"	120-157-230

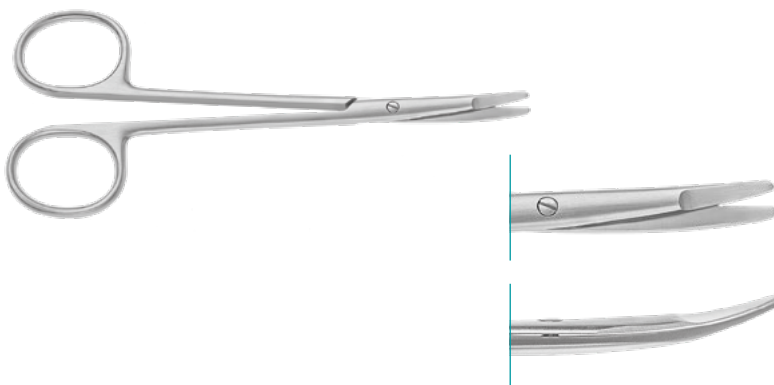

KILNER RAGNELL

curved, blunt

130mm, 5 ¹ / ₈ "	120-065-130
150mm, 6"	120-065-150
180mm, 7"	120-065-180
200mm, 8"	120-065-200
230mm, 9"	120-065-230



METZENBAUM NELSON

blunt, straight

180mm, 7"	120-110-180
200mm, 8"	120-110-200
230mm, 9"	120-110-230
250mm, 9 ⁷ / ₈ "	120-110-250
280mm, 11"	120-110-280
300mm, 11 ⁷ / ₈ "	120-110-300

blunt, curved

180mm, 7"	120-111-180
200mm, 8"	120-111-200
230mm, 9"	120-111-230
250mm, 9 ⁷ / ₈ "	120-111-250
280mm, 11"	120-111-280
300mm, 11 ⁷ / ₈ "	120-111-300

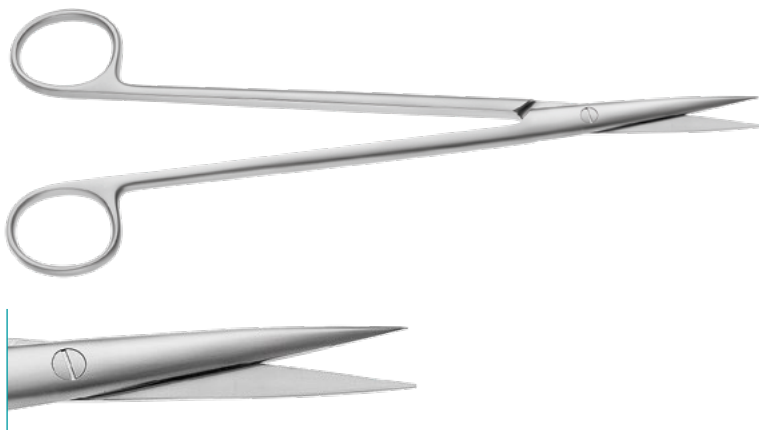

METZENBAUM NELSON

straight, sharp/sharp

145mm, 5 ³ / ₄ "	120-114-145
180mm, 7"	120-114-180
200mm, 8"	120-114-200

curved, sharp/sharp

145mm, 5 ³ / ₄ "	120-115-145
180mm, 7"	120-115-180
200mm, 8"	120-115-200

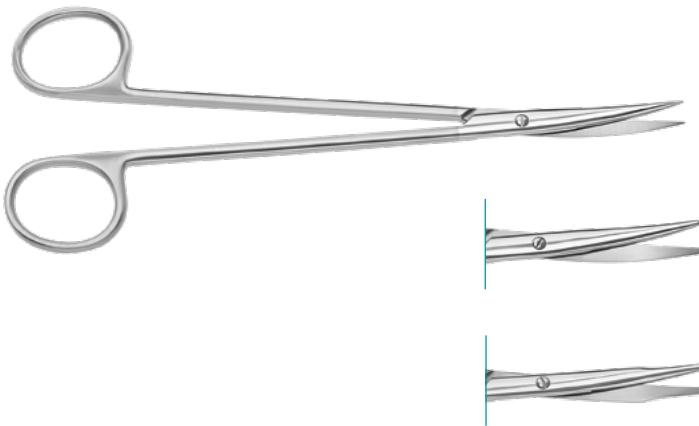

LILLEHEI POTTS

straight, 180mm, 7"

sharp 125-322-180

blunt 125-326-180

blunt, tenotomy 125-328-180

curved, 180mm, 7"

sharp 125-323-180

blunt 125-327-180

blunt, tenotomy 125-329-180

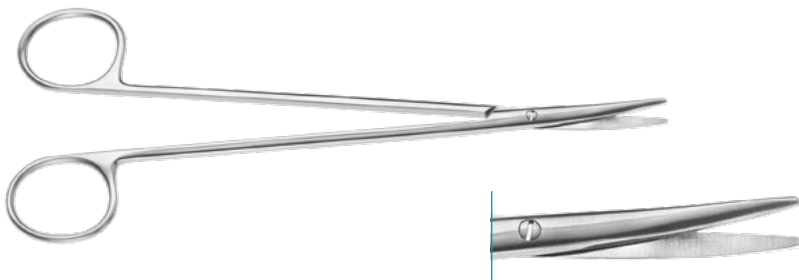

DEBAKEY

Dissecting Scissors, slightly curved

175mm, 6⁷/₈" 120-135-175

200mm, 8" 120-135-200

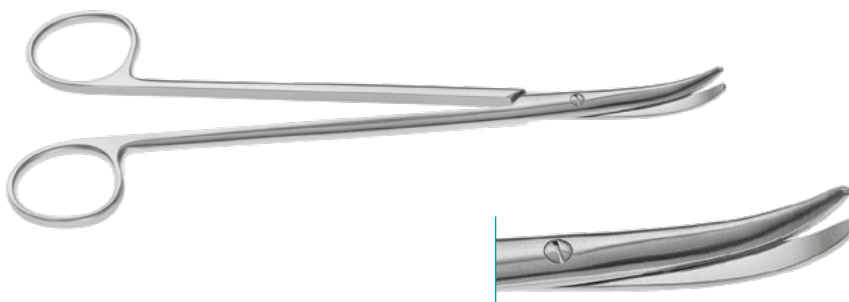

THOREK

Dissecting Scissors

190mm, 7¹/₂" 120-133-190

230mm, 9" 120-133-230



COTTLE MASING

Nasal pasticc scissors, curved, 105mm, 4¹/₈"

blunt 120-112-110

sharp 120-110-110



BROWN

Dissecting Scissors, curved

140mm, 5¹/₂" 120-048-140

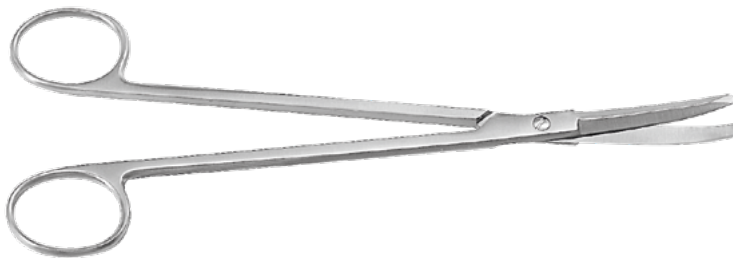

POTTS SMITH

Dissecting Scissors, curved

145mm, 5³/₄" 120-216-145

190mm, 7¹/₂" 120-216-190

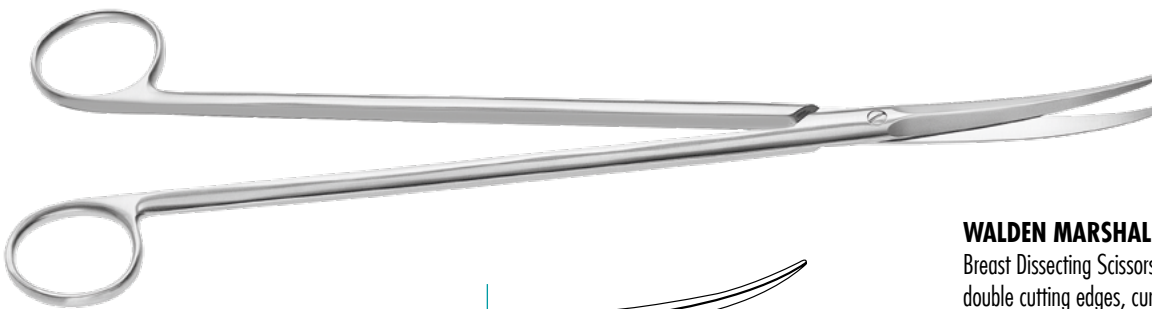

A

B

C

D

WALDEN MARSHALL

Breast Dissecting Scissors,
double cutting edges, curved

230mm, 9" 120-580-230

250mm, 9⁷/₈" 120-580-250

305mm, 12" 120-580-305

355mm, 14" 120-580-355

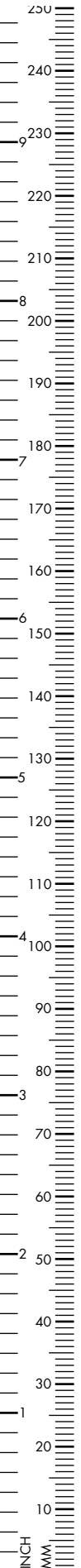



JOSEPH

sharp, 140mm, 5¹/₂"

straight	120-058-140
curved	120-059-140



KELLY

160mm, 6¹/₄"

straight	120-046-160
curved	120-047-160

200mm, 8"

straight	120-046-200
curved	120-047-200

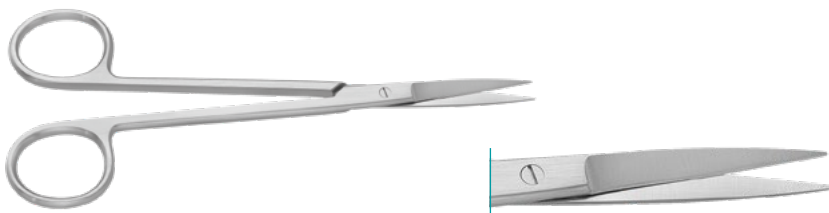

SANVENERO

sharp, 140mm, 5¹/₂"

straight	120-056-140
curved	120-057-140



REYNOLDS

curved

150mm, 6"	120-043-150
-----------	-------------

180mm, 7"	120-043-180
-----------	-------------

curved, toothed

150mm, 6"	120-043-151
-----------	-------------

180mm, 7"	120-043-181
-----------	-------------

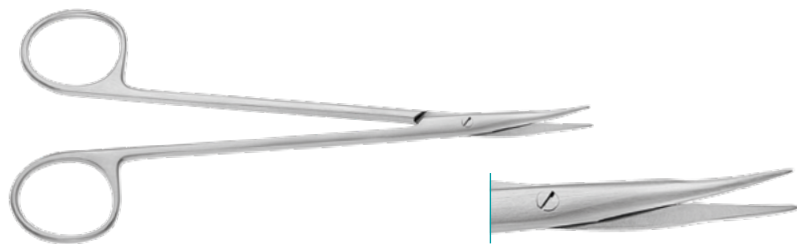

JAMESON WERBER

curved

130mm, 5 ¹ / ₈ "	120-313-130
--	-------------



JAMESON

curved, blunt

150mm, 6"	120-315-150
-----------	-------------

180mm, 7"	120-315-180
-----------	-------------

200mm, 8"	120-315-200
-----------	-------------

230mm, 9"	120-315-230
-----------	-------------

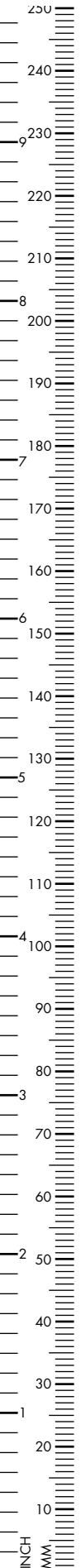



LISTER

Bandage Scissors

90mm, 3 ¹ / ₂ "	190-165-090
110mm, 4 ¹ / ₃ "	190-165-110
140mm, 5 ¹ / ₂ "	190-165-140
180mm, 7"	190-165-180
200mm, 8"	190-165-200



LISTER

Bandage Scissors with 1 large ring

210mm, 8 ¹ / ₄ "	190-170-210
--	-------------



KNOWLES

Bandage Scissors, 140mm, 5¹/₂"

Straight	190-160-140
Angled	190-161-140
Straight, knee bent shanks	190-162-140



UNIVERSAL

small, 140mm, 5½"

black	190-209-151
red	190-209-152
yellow	190-209-153
green	190-209-154



UNIVERSAL

large, 180mm, 7"

blue	190-209-180
black	190-209-181
red	190-209-182
yellow	190-209-183
green	190-209-184
orange	190-209-185

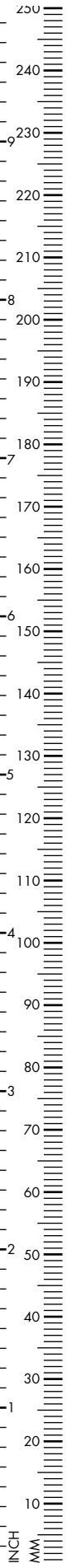



LORENZ

Bandage Scissors, curved

230mm, 9"

190-155-230



BERGMANN

Plaster Scissors

230mm, 9"

190-195-230



ESMARCH

Plaster Scissors

200mm, 8"

190-205-200

220mm, 8^{2/3}"

190-205-220

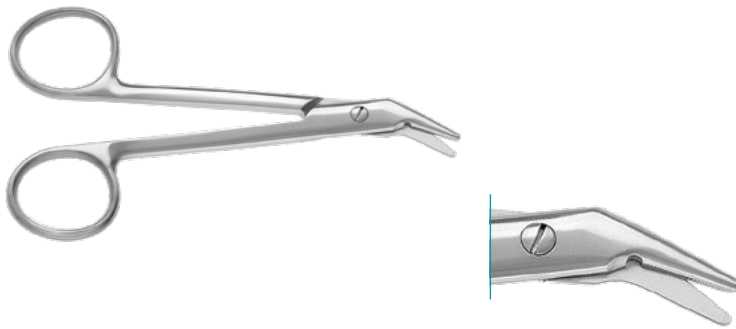

Wire Cutting Scissors, serrated

120mm, 4 ³ / ₄ "	120-265-120
--	-------------

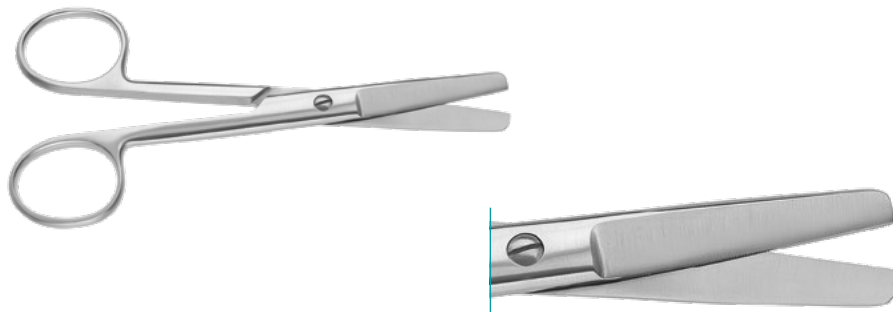

HARVEY

Wire Cutting Scissors, both serrated blade, straight

125mm, 5"	120-262-125
-----------	-------------

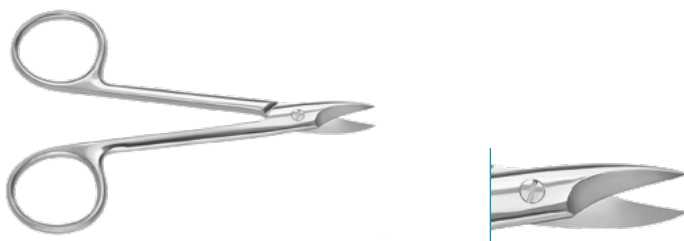

Crown & Collar Scissors, straight, serrated

100mm, 4"	120-296-100
-----------	-------------

120mm, 4 ³ / ₄ "	120-296-120
--	-------------

curved

100mm, 4"	120-297-100
-----------	-------------

120mm, 4 ³ / ₄ "	120-297-120
--	-------------

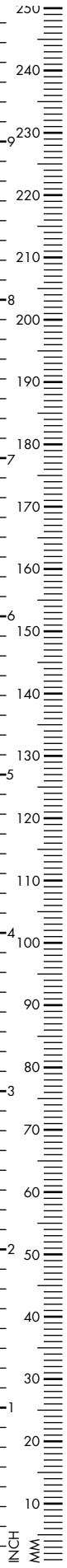



SPENCER

Suture Scissors, straight

90mm, 3 ¹ / ₂ "	120-220-090
---------------------------------------	-------------

130mm, 5 ¹ / ₈ "	120-220-130
--	-------------

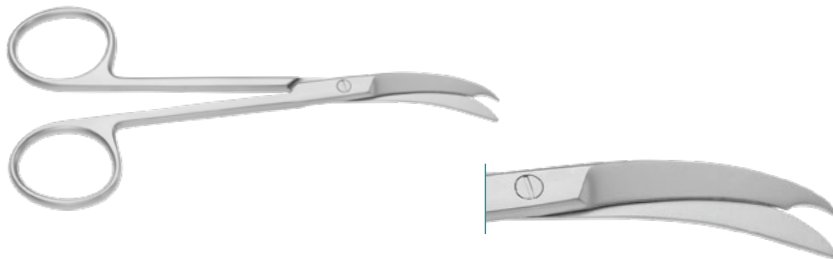

NORTHBENT

Ligature Scissors, curved

130mm, 5 ¹ / ₈ "	120-222-130
--	-------------

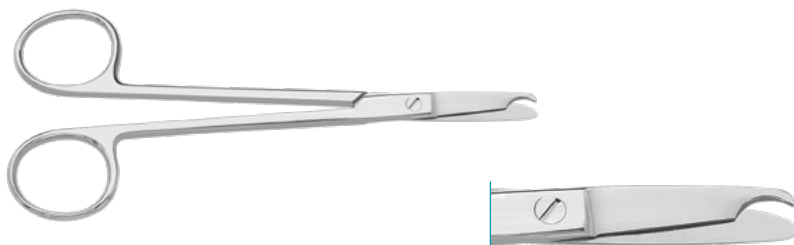

LITTAUER

Ligature Scissors, straight

115mm, 4 ¹ / ₂ "	120-224-115
--	-------------

140mm, 5 ¹ / ₂ "	120-224-140
--	-------------



Stitch Removal Scissors, curved, ribbon handle
100mm, 4" 120-078-100



BUCK
Ligature Scissors, straight
145mm, 5³/₄" 120-228-145
180mm, 7" 120-228-180



Ligature Scissors, SC, TC inserts, curved,
serrated blades
115mm, 4¹/₂" 120-611-115
140mm, 5¹/₂" 120-611-140
180mm, 7" 120-611-180
230mm, 9" 120-611-230

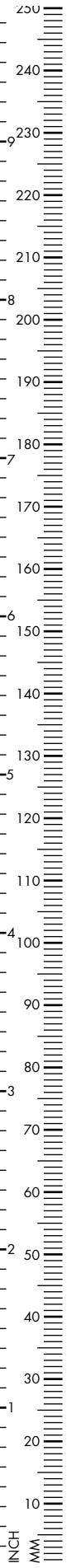
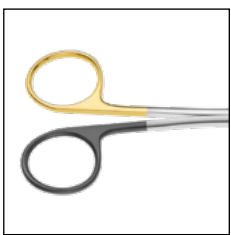

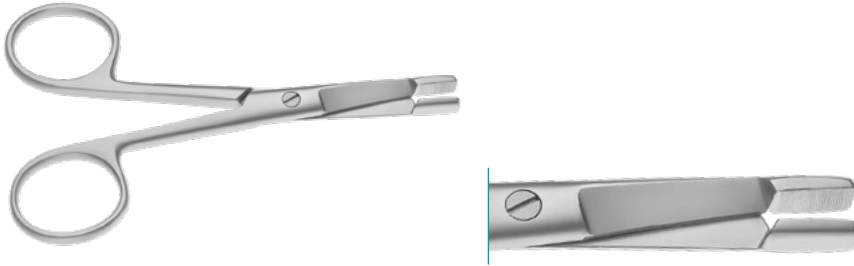

EISELSBERG
Ligature Scissors

120mm, 4^{3/4}"

120-230-120

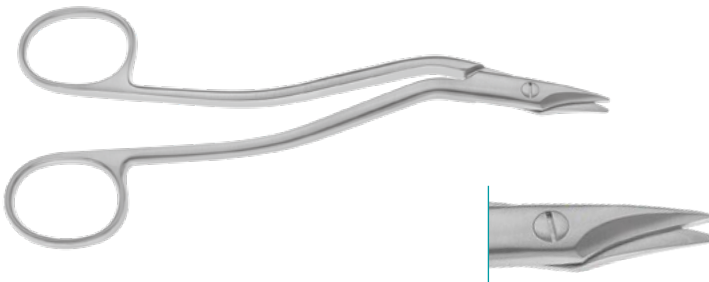

HEATH
Ligature Scissors

160mm, 6^{1/4}"

120-226-160



NEW'S
Suture Scissors, angled on flat

165mm, 6^{1/2}"

120-225-165

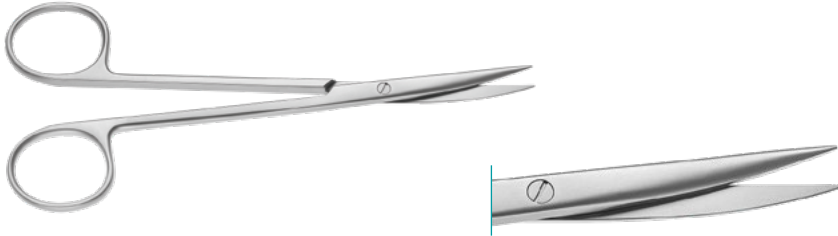

BROPHY

Gum and Suture Scissors, 140mm, 5^{1/2}"

straight	120-054-140
curved	120-055-140



LITTLER

Suture Scissors, with hole, slightly curved, sharp

115mm, 4 ^{1/2} "	120-061-115
---------------------------	-------------



O'BRIEN

Suture Scissors

95mm, 3 ^{3/4} "	120-084-095
--------------------------	-------------



MARTIN

Cartilage Scissors

200mm, 8"

120-206-200

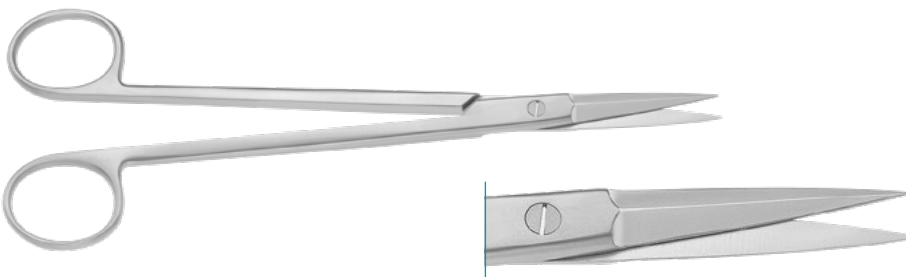

MCINDOE

Cartilage Scissors, straight, sharp/sharp
serrated blade, outside cutting blades

185mm, 7¹/₄"

120-190-190



RESANO

Capsule Scissors, angled, sharp/blunt

250mm, 9⁷/₈"

120-241-250

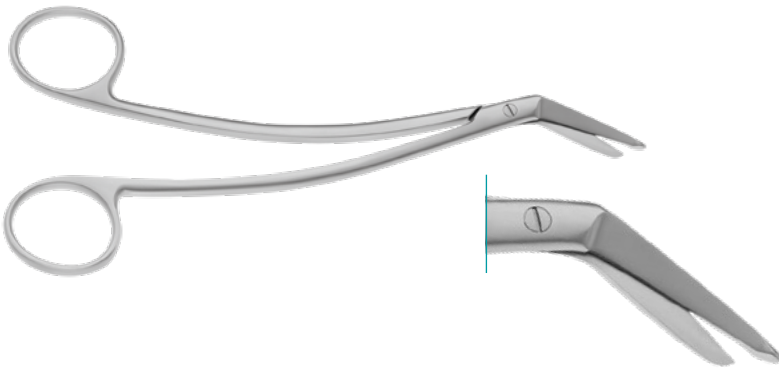
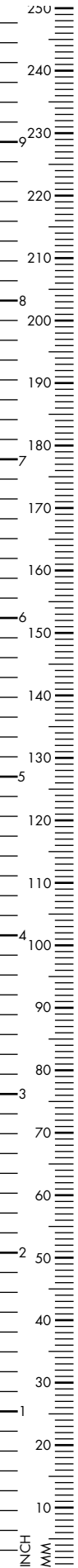

SCHMIEDEN-TAYLOR

Dura Scissors

170mm, 6²/₃"

120-430-170

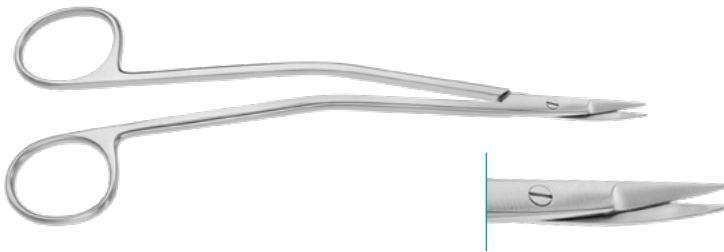

DANDY

Neurosurgical Scissors, s-shape

170mm, 6²/₃"

120-253-170

195mm, 7³/₄"

120-253-195

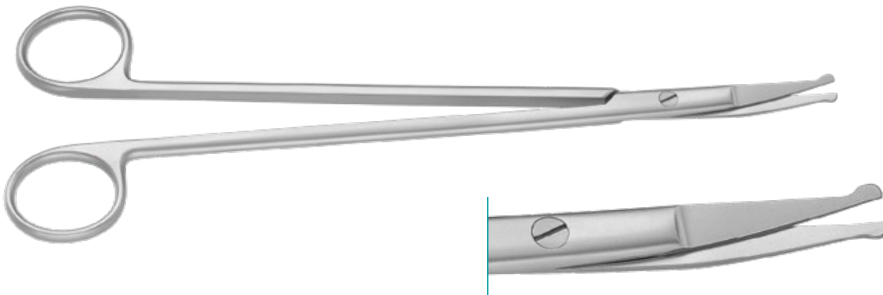

STRULLY

Neurosurgical Scissors, curved,
220mm, 8²/₃"

with probe point

120-250-220

without probe point

120-251-220



Nerve dissection Scissors, 150mm, 6"

straight

120-120-150

curved

120-121-150



HOHENFELLER

S-Curved

180mm, 7"	120-060-180
210mm, 8 ^{1/4} "	120-060-210
240mm, 9 ^{1/2} "	120-060-240

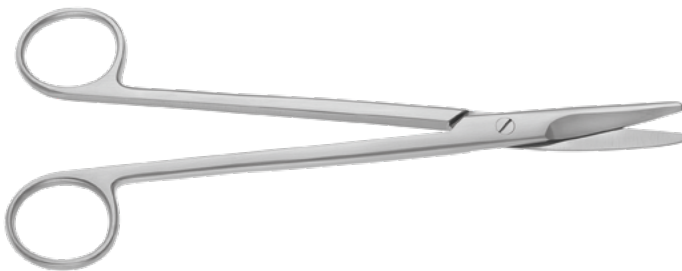

COOLEY

Vascular Scissors, curved

180mm, 7"	120-134-180
230mm, 9"	120-134-230



SATINSKY

Vascular Scissors, s-curved

245mm, 9 ^{2/3} "	120-203-245
---------------------------	-------------

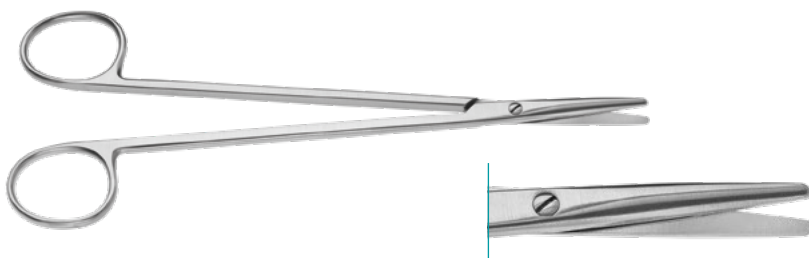

LINCOLN

Vascular Scissors, straight

170mm, 6 ^{2/3} "	120-260-170
---------------------------	-------------

curved

170mm, 6 ^{2/3} "	120-261-170
---------------------------	-------------

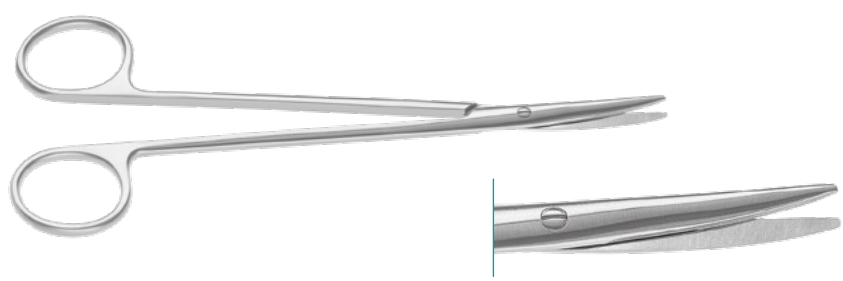
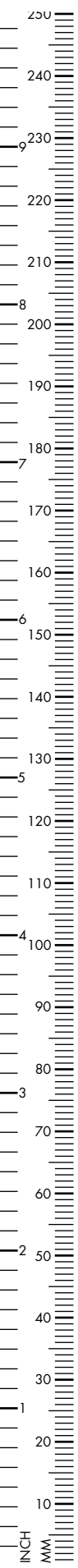

DE MARTEL

Vascular Scissors, 175mm, 6⁷/₈"

blunt	120-261-175
sharp	120-263-175

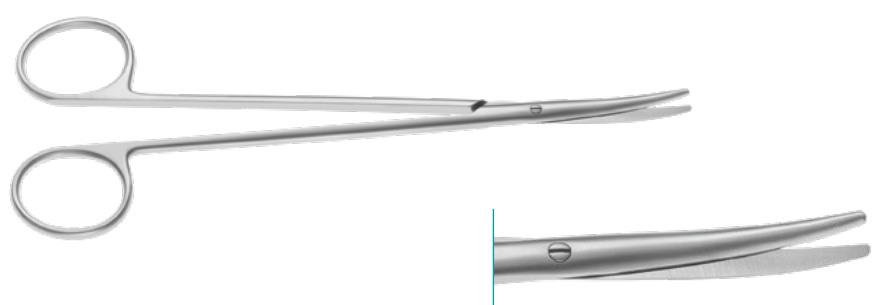

DEBAKEY

Endarterectomy Scissors, 180mm, 7"

slightly curved	120-319-180
strongly curved	120-320-180

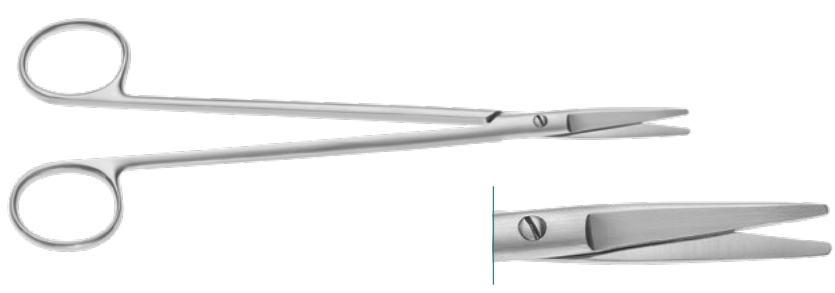

TOENNIS

Vascular Scissors, 180mm, 7"

Straight	120-254-180
Curved	120-255-180

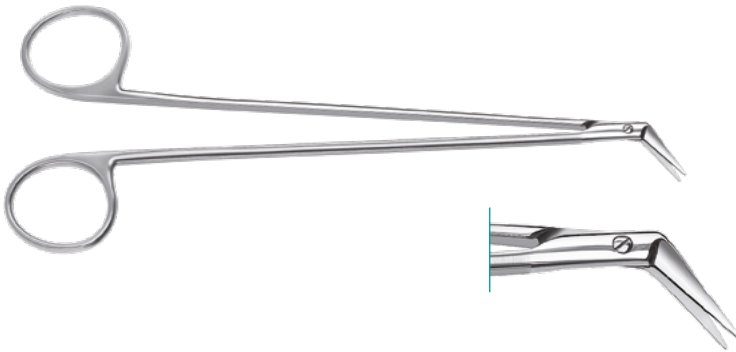

DIETRICH

delicate, 14mm, 180mm, 7"

25°	125-175-025
45°	125-175-045
60°	125-175-060
90°	125-175-090
125°	125-175-125

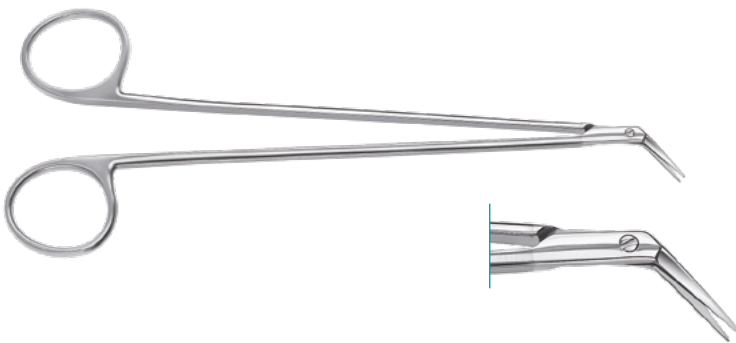

DIETRICH

extra delicate, 14mm, 180mm, 7"

25°	125-170-025
45°	125-170-045
60°	125-170-060
90°	125-170-090
125°	125-170-125

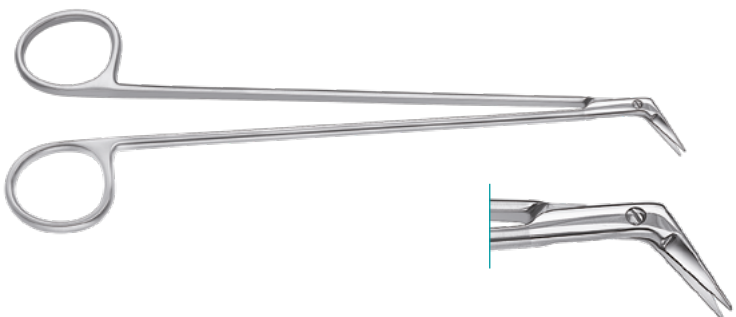

DIETRICH HEGEMANN

13mm, 180mm, 7"

0°	125-180-000
25°	125-180-025
45°	125-180-045
60°	125-180-060
90°	125-180-090
125°	125-180-125

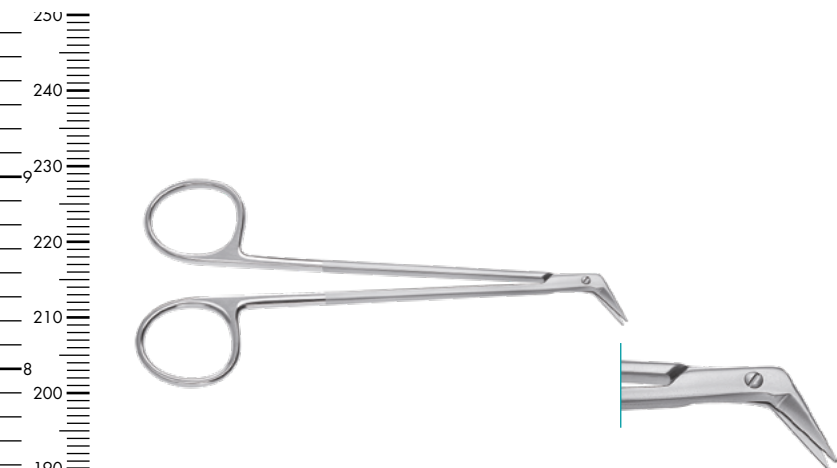

DIETRICH

Peripheral, 13mm, 130mm, 5 1/8"

25°	125-130-025
45°	125-130-045
60°	125-130-060
90°	125-130-090
125°	125-130-125

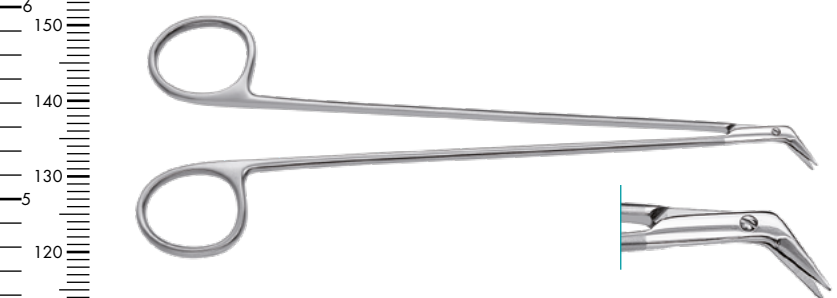

DIETRICH

9mm, 180mm, 7"

25°	125-178-025
45°	125-178-045
60°	125-178-060
90°	125-178-090
125°	125-178-125

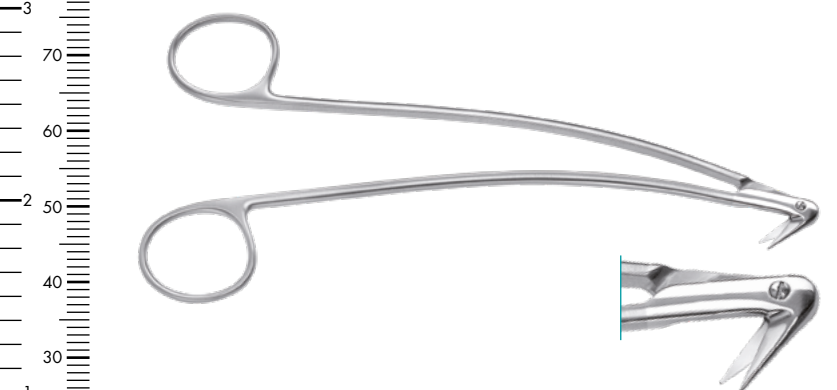

DIETRICH FAVALORO

13mm, 180mm, 7"

125°	125-185-125
------	-------------

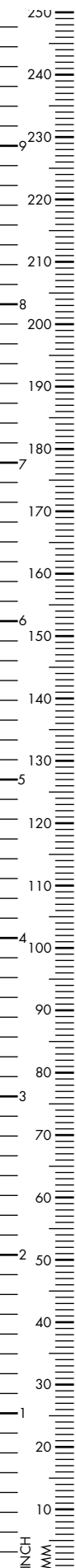

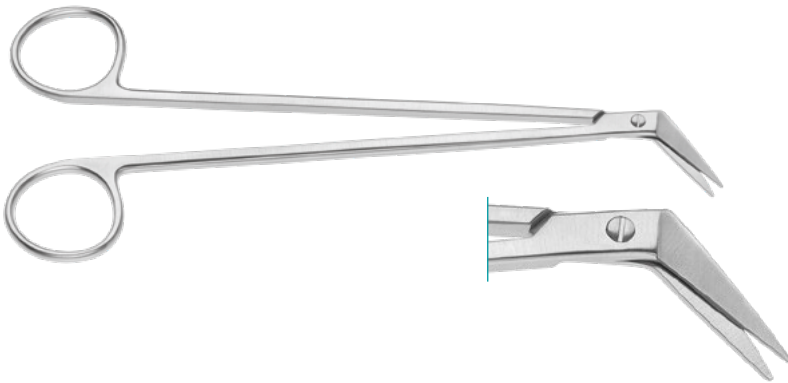

POTTS SMITH

190mm, 7^{1/2}"

25°	120-181-190
40°	120-182-190
60°	120-183-190

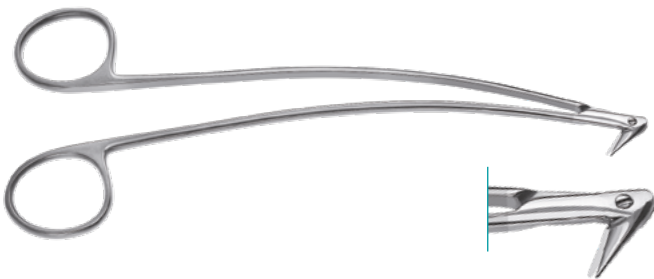

DIETHRICH FAVALORO

9mm, 170mm, 6^{3/4}"

125°	125-168-025
------	-------------

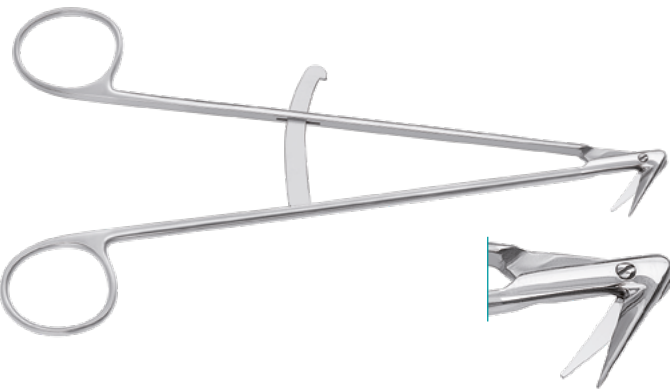

DIETHRICH ARTEY

13mm, 180mm, 7"

125°	125-200-125
------	-------------



BEALL

Circumflex, 150mm, 6"

115°	125-300-115
------	-------------

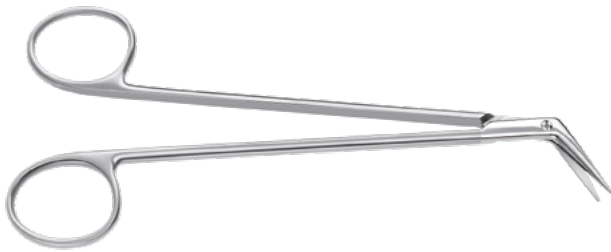

DIETRICH

26mm, 160mm, 6¹/₄"

25°, blunt tip	125-216-025
25°, sharp tip	125-217-025
45°, blunt tip	125-216-045
45°, sharp tip	125-217-045

225mm, 8⁷/₈"

25°, blunt tip	125-220-025
25°, sharp tip	125-221-025
45°, blunt tip	125-220-045
45°, sharp tip	125-221-045
60°, blunt tip	125-220-060
60°, sharp tip	125-221-060

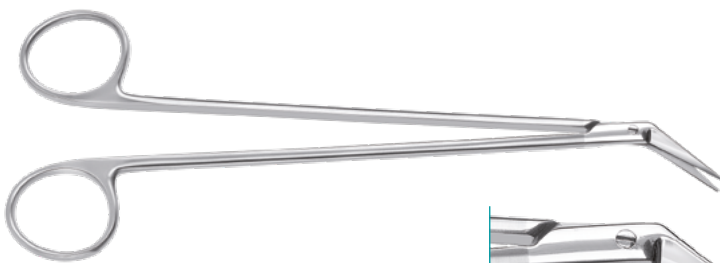

POTTS SMITH

22mm, 190mm, 7¹/₂"

25°	125-490-025
45°	125-490-045
60°	125-490-060



POTTS SMITH

22mm, 140mm, 5¹/₂"

25°	125-440-025
45°	125-440-045
60°	125-440-060

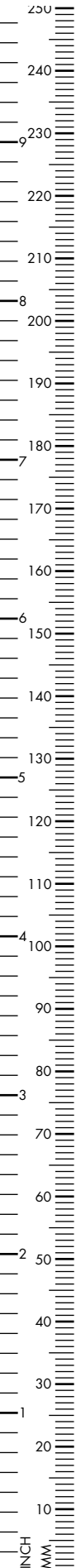



KNAPP

Iris Scissors, 105mm, 4¹/₈"
straight

sharp/sharp	120-174-105
-------------	-------------

sharp/blunt	120-175-105
-------------	-------------

blunt/blunt	120-176-105
-------------	-------------

curved

sharp/sharp	120-179-105
-------------	-------------

sharp/blunt	120-178-105
-------------	-------------

blunt/blunt	120-177-105
-------------	-------------

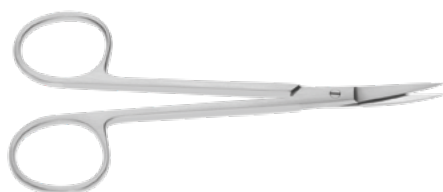

Iris Scissors, straight

90mm, 3 ¹ / ₂ "	120-070-090
---------------------------------------	-------------

105mm, 4 ¹ / ₈ "	120-070-105
--	-------------

115mm, 4 ¹ / ₂ "	120-070-115
--	-------------

curved

90mm, 3 ¹ / ₂ "	120-071-090
---------------------------------------	-------------

105mm, 4 ¹ / ₈ "	120-071-105
--	-------------

115mm, 4 ¹ / ₂ "	120-071-115
--	-------------



Iris Scissors, square model, 120mm, 4³/₄"

straight	120-086-120
----------	-------------

curved	120-087-120
--------	-------------

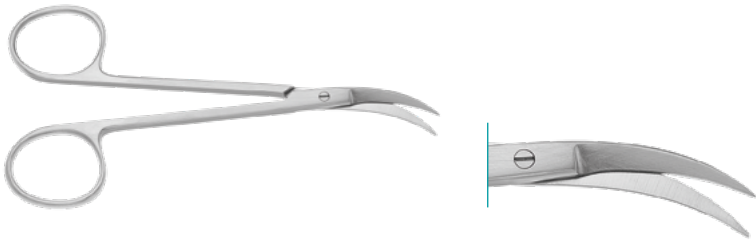

Iris Scissors, sideways curved

115mm, 4 1/2"

120-083-115

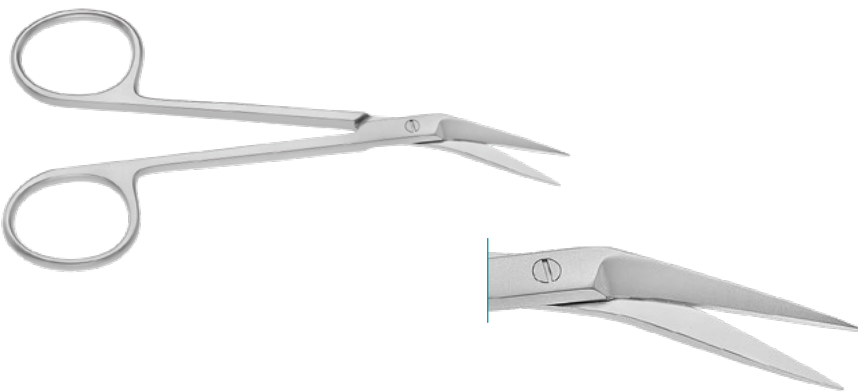

Iris Scissors, angled to side

115mm, 4 1/2"

120-085-115

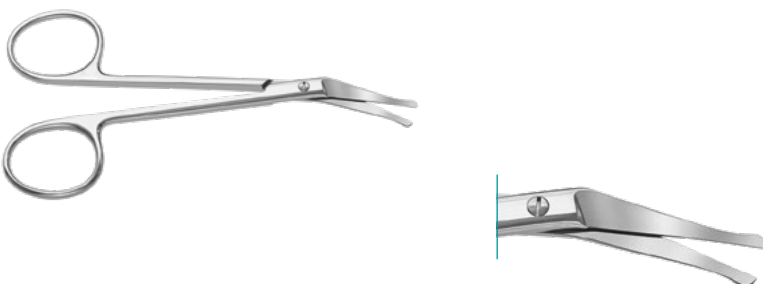

Iris Scissors, angled on side, probe point

115mm, 4 1/2"

120-360-103

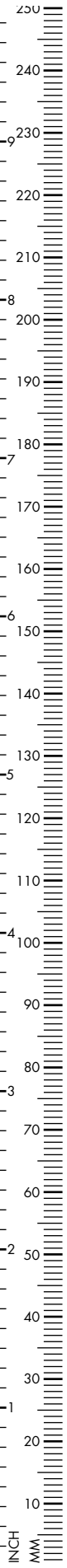

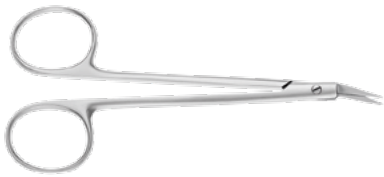

WILMER

Utility Scissors, angled on flat

100mm, 4"	120-084-100
-----------	-------------



Iris Scissors, sharp, large rings, 100mm, 4",

straight	120-082-100
----------	-------------

curved	120-083-100
--------	-------------



Iris Scissors, 105mm, 4¹/₈"

straight	120-080-105
----------	-------------

curved	120-081-105
--------	-------------

115mm, 4¹/₂"

straight	120-080-115
----------	-------------

curved	120-081-115
--------	-------------

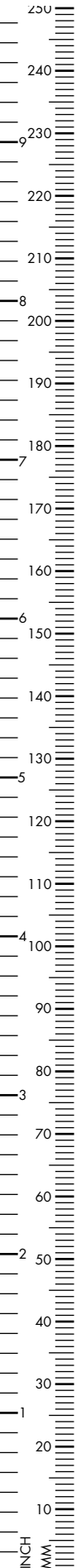

BONN

Iris Scissors, very delicate, 90mm, 3¹/₂" sharp

straight	120-072-080
curved	120-073-080
<hr/>	
blunt	
straight	120-074-080
curved	120-075-080

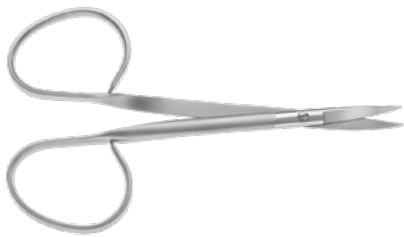

Iris Scissors, sharp, ribbon handle, 105mm, 4¹/₈"

straight	120-078-105
curved	120-083-105

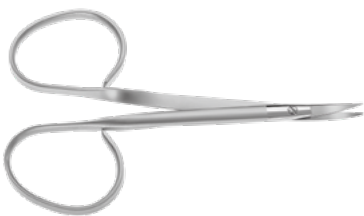

Iris Scissors, sharp, ribbon handle, 95mm, 3³/₄"

straight	120-080-095
curved	120-081-095



Strabismus Scissors, 115mm, 4^{1/2}"

straight	120-094-115
curved	120-095-115

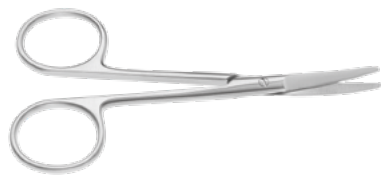

KNAPP

Strabismus Scissors, blunt, 105mm, 4^{1/8}"

straight	400-112-105
curved	400-113-105

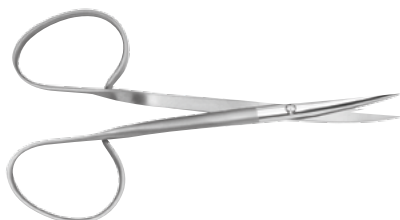

Strabismus Scissors, ribbon handle,
105mm, 4^{1/8}"

straight	120-094-105
curved	120-095-105

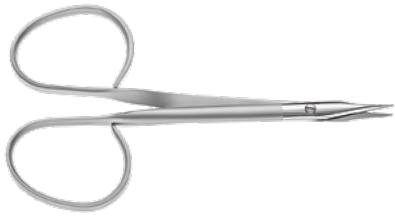
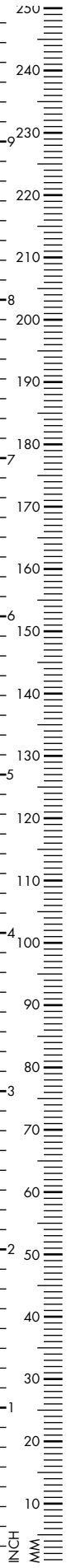

GRADLE WALTON

curved, sharp, ribbon handle

100mm, 4"

120-133-200



Enucleation Scissors, medium curved

110mm, 4^{1/3}"

120-082-110



Enucleation Scissors
slightly curved, blunt

130mm, 5^{1/8}"

400-881-130

strongly curved

130mm, 5^{1/8}"

400-883-130



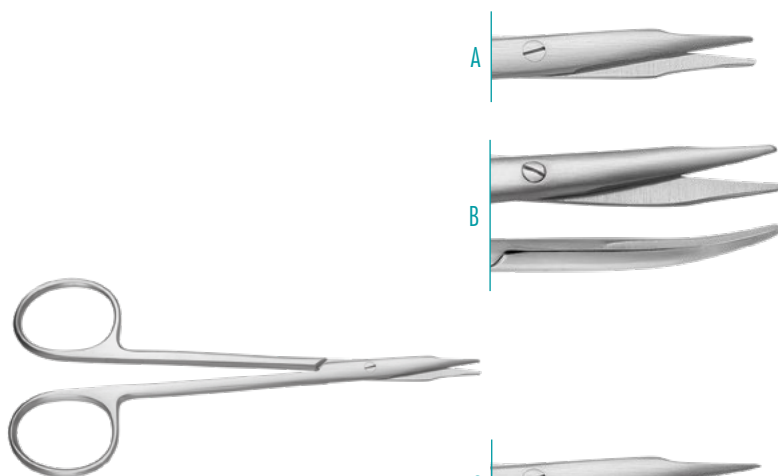

A

B

C

D

STEVENS

A Tenotomy Scissors, ring handle, blunt, straight

105mm, 4¹/₈" 120-092-105

115mm, 4¹/₂" 120-092-115

125mm, 5" 120-092-125

B blunt, curved

90mm, 3¹/₂" 120-093-090

105mm, 4¹/₈" 120-093-105

115mm, 4¹/₂" 120-093-115

125mm, 5" 120-093-125

C sharp, straight

105mm, 4¹/₈" 120-090-105

115mm, 4¹/₂" 120-090-115

125mm, 5" 120-090-125

D sharp, curved

105mm, 4¹/₈" 120-091-105

115mm, 4¹/₂" 120-091-115

125mm, 5" 120-091-125



A

B

STEVENS RIBBON

A blunt, straight, ribbon handle

100mm, 4" 120-098-100

B blunt, curved, ribbon handle

100mm, 4" 120-099-100



A

WALTON

Tenotomy Scissors, curved, sharp, ribbon handle

95mm, 3³/₄" 120-091-095



CINELLI

Lower Lateral Nasal Scissors

127mm, 5"

120-338-110



FOMON

Lower Lateral Nasal Scissors

120mm, 4^{3/4}"

120-339-120



FOMON

Lateral Scissors, fully curved

170mm, 6^{2/3}"

120-339-170

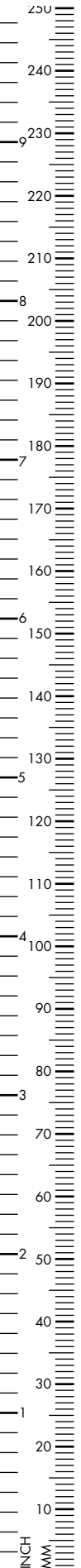



BEUSE

Nasal Scissors, slightly curved

110mm, 4¹/₃"

120-281-110

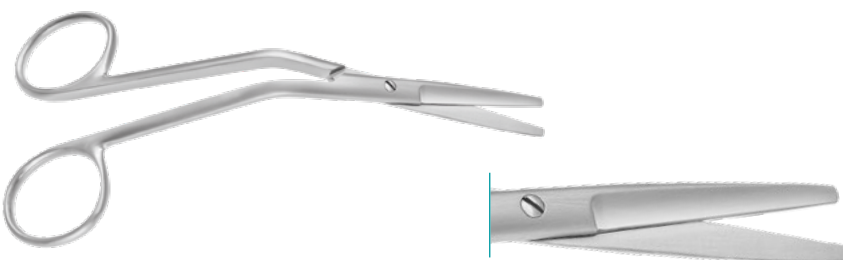

FOMON

Nasal Scissors, serrated, knee bent

145mm, 5³/₄"

120-280-150

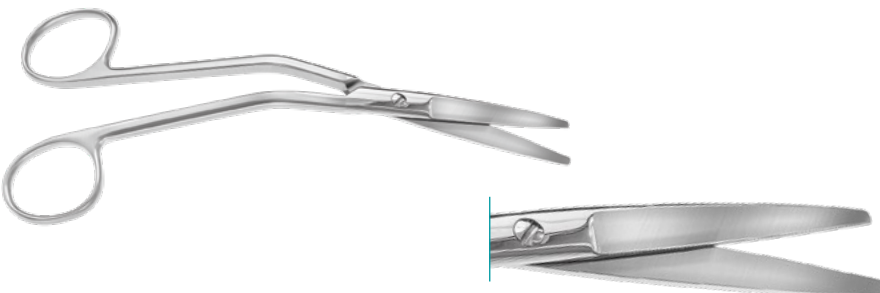

GOLDMAN

Nasal Scissors, knee bent

147mm, 6"

120-356-150



BOETTCHER

Tonsill Scissors, curved

180mm, 7"

120-209-180



COTTLE

Nasal Scissors, knee bent

160mm, 6^{1/4}"

120-281-160



COTTLE

Septum Scissors, serrated blade

175mm, 6^{7/8}"

420-119-175



SEILER

Nasal Scissors, angled

170mm, 6^{2/3}"

120-289-170



HEYMAN KNIGHT

Nasal Scissors, knee bent

180mm, 7"

120-283-180

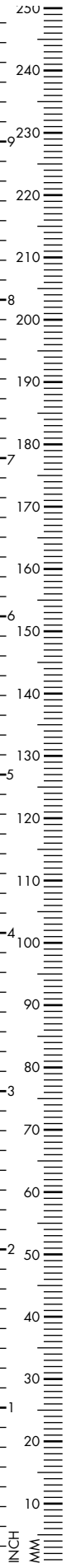

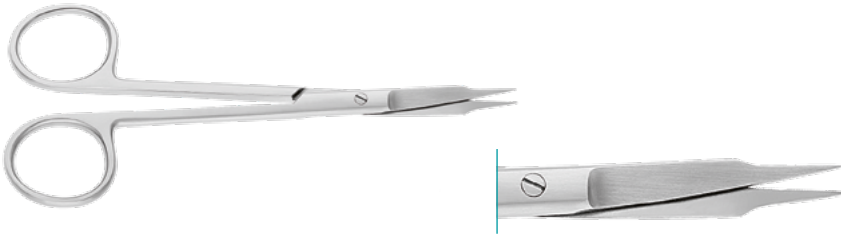

GOLDMAN FOX

Gum Scissors, 1 blade serrated,
straight

130mm, 5¹/₈" 120-666-130

curved

130mm, 5¹/₈" 120-667-130

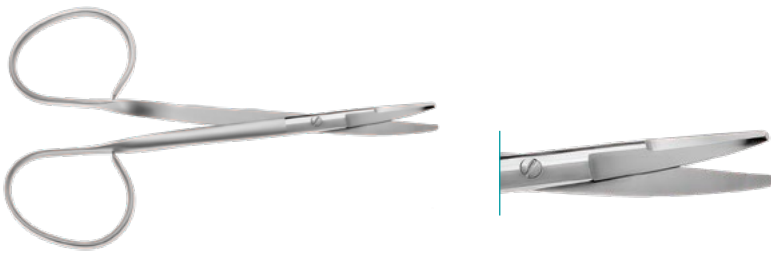

KAYE

Blepharoplasty Scissors, ribbon handle,
curved

115mm, 4¹/₂" 120-135-115

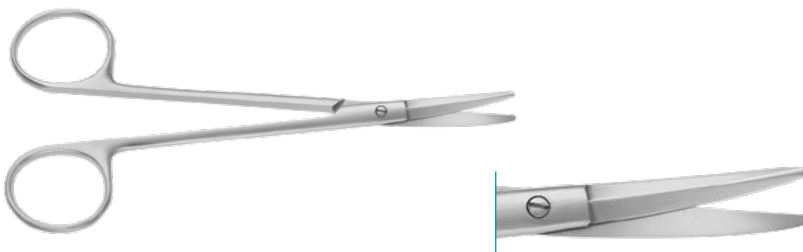

FOMON

Saber Scissors, curved

135mm, 5¹/₃" 120-139-135



DOYEN

Scissors, 160mm, 6¹/₄"

straight 120-040-160

curved 120-041-160

175mm, 6⁷/₈"

straight 120-040-175

curved 120-041-175

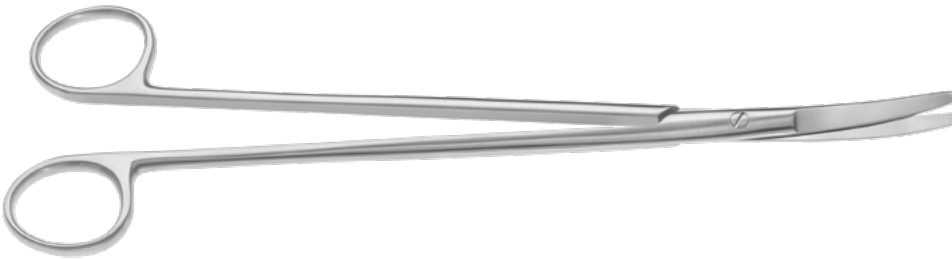

WILLAUER

Scissors, straight

250mm, 9⁷/₈" 120-214-250

280mm, 11" 120-214-280

curved

250mm, 9⁷/₈" 120-215-250

280mm, 11" 120-215-280



JORGENSEN

Scissors, curved

220mm, 8²/₃" 120-325-220



Enterotomy Scissors

210mm, 8¹/₄"

A 120-233-210

B 120-234-210

C 120-235-210



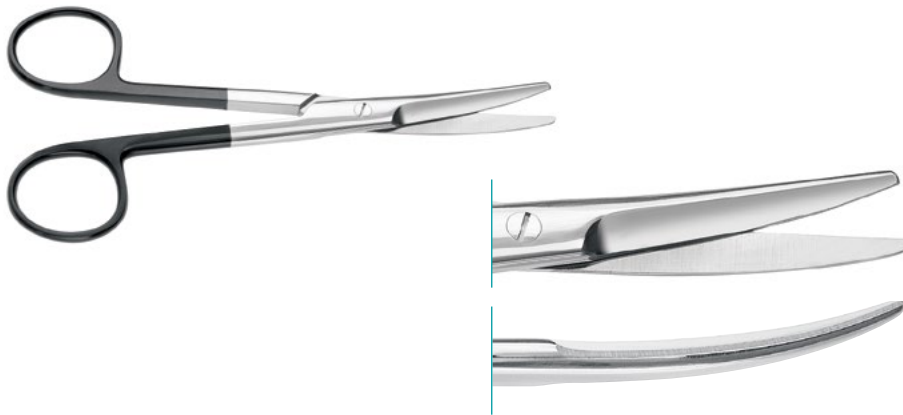

MAYO SC

Surgical Scissors, straight

145mm, 5 ³ / ₄ "	121-030-145
--	-------------

170mm, 6 ² / ₃ "	121-030-170
--	-------------

230mm, 9"	121-030-230
-----------	-------------

curved

145mm, 5 ³ / ₄ "	121-031-145
--	-------------

170mm, 6 ² / ₃ "	121-031-170
--	-------------

230mm, 9"	121-031-230
-----------	-------------

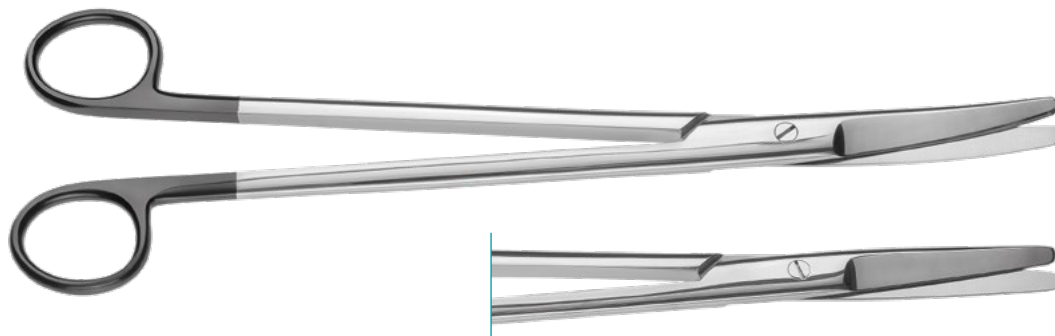

MAYO HARRINGTON SC

curved

280mm, 11"	121-033-280
------------	-------------

straight

300mm, 11 ⁷ / ₈ "	121-032-300
---	-------------

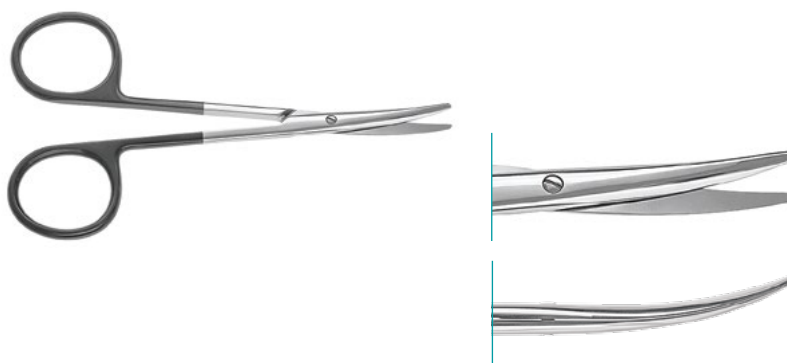

METZENBAUM BABY SC

Dissecting Scissors, curved

110mm, 4 ¹ / ₃ "	121-317-110
--	-------------

145mm, 5 ³ / ₄ "	121-317-145
--	-------------

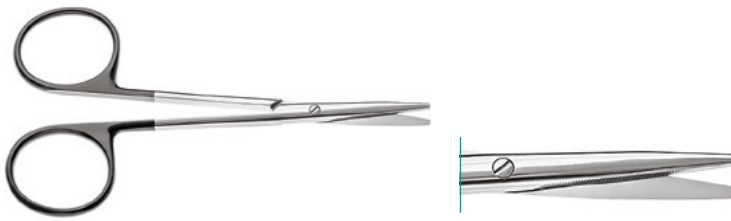

STRABISMUS SC

Dissecting Scissors, 115mm, 4¹/₂"

straight	121-094-115
curved	121-095-115



METZENBAUM SC

145mm, 5³/₄"

straight	121-110-145
curved	121-111-145



METZENBAUM NELSON SC

curved, blunt

180mm, 7"	121-111-180
200mm, 8"	121-111-200
230mm, 9"	121-111-230
280mm, 11"	121-111-280
300mm, 11 ⁷ / ₈ "	121-111-300
355mm, 14"	121-111-355
straight	
180mm, 7"	121-110-180
200mm, 8"	121-110-200
230mm, 9"	121-110-230
260mm, 11"	121-110-260

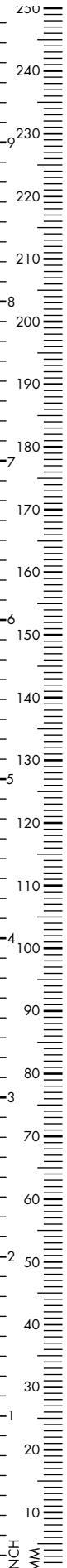

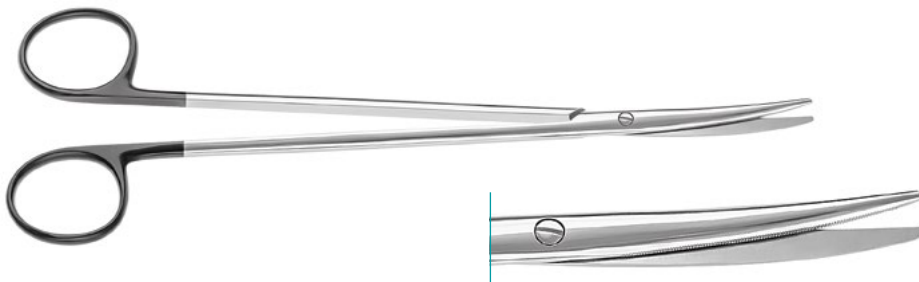

METZENBAUM FINO SC

curved, blunt

115mm, 4 ^{1/2} "	121-153-115
145mm, 5 ^{3/4} "	121-153-145
180mm, 7"	121-153-180
200mm, 8"	121-153-200
230mm, 9"	121-153-230

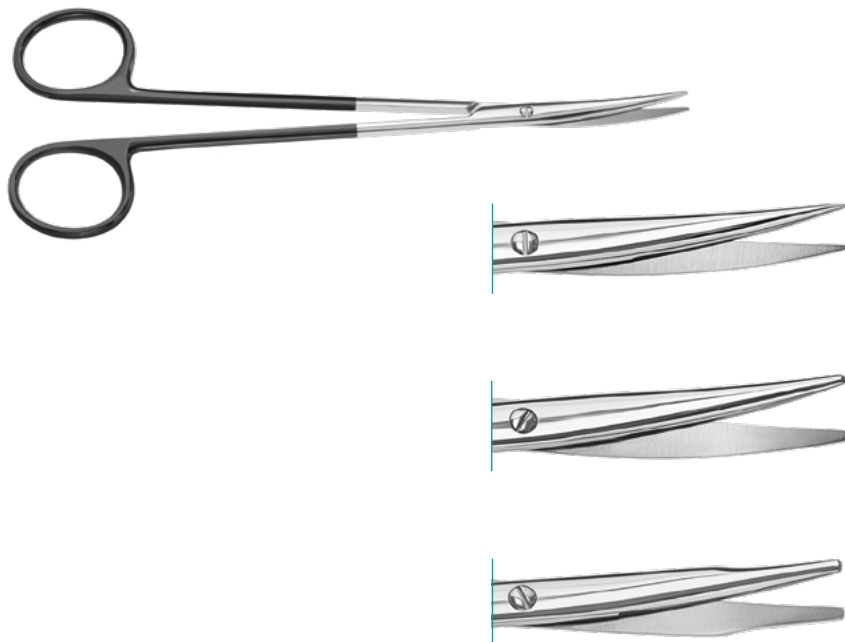

LILLEHEI POTTS SC

curved, 180mm, 7"

sharp	126-312-180
blunt	126-313-180
blunt, tenotomy	126-314-180

curved, 230mm, 9"

sharp	126-312-230
blunt	126-313-230
blunt, tenotomy	126-314-230

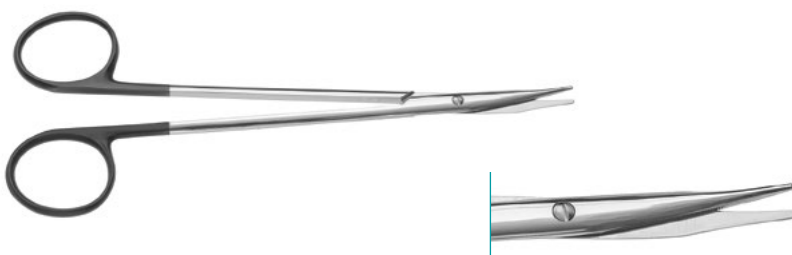

JAMESON SC

curved, blunt

150mm, 6"	121-315-150
180mm, 7"	121-315-180



RZ DAVIS SC

curved, sharp

180mm, 7"

121-313-170

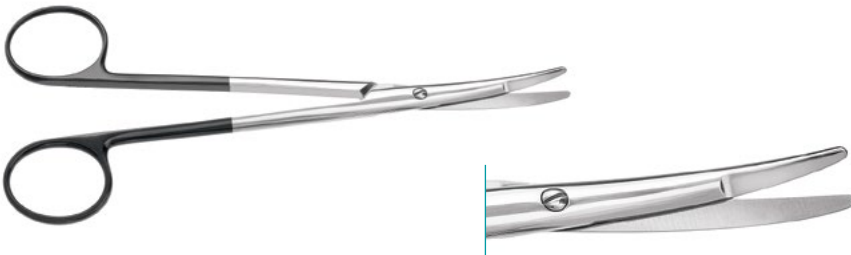

RAGNELL KILNER SC

curved, flat, blunt

150mm, 6"

121-332-150

180mm, 7"

121-332-180

200mm, 8"

121-332-200



PAR TYPE SC

curved

110mm, 4^{1/3}"

121-331-110

150mm, 6"

121-331-150



FOMON SC

Lateral Scissors, strongly curved

110mm, 4¹/₃"

121-131-110

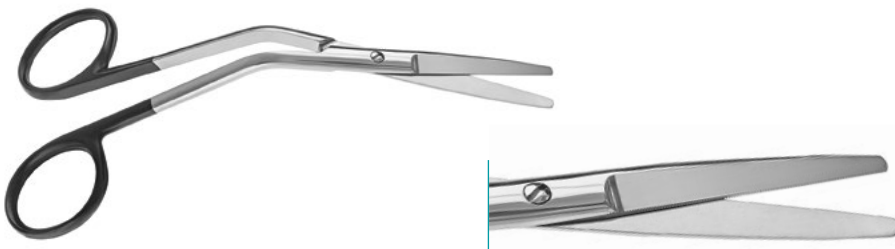

FOMON SC

Dorsal Scissors, straight, shanks knee bent

145mm, 5³/₄"

121-280-145

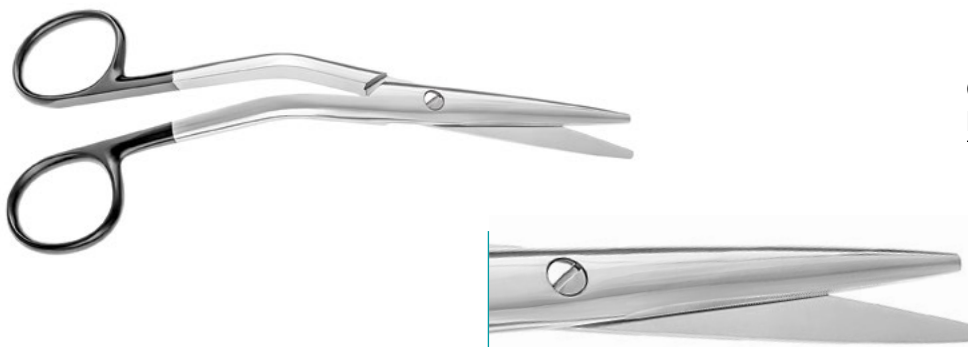

COTTLE SC

Dorsal Scissors, shanks knee bent

170mm, 6²/₃"

121-290-165

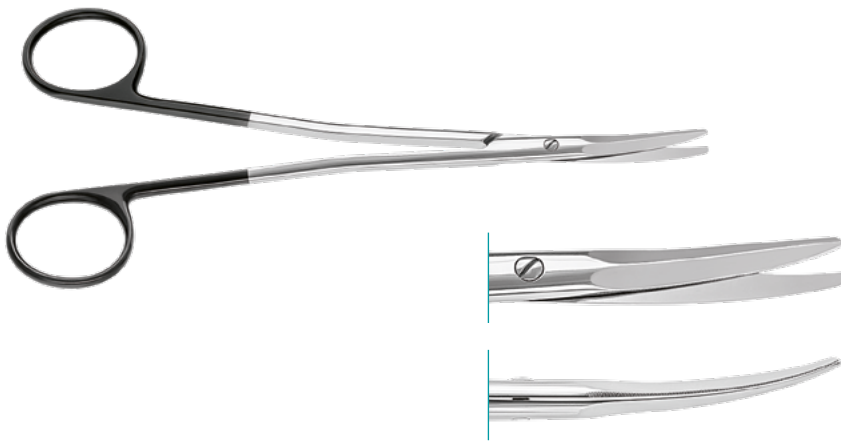
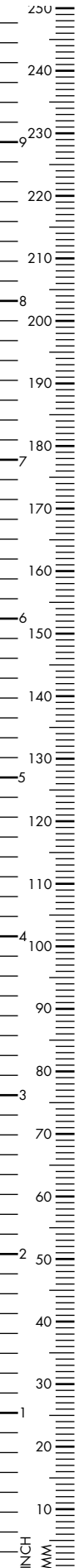

KAYE FREEMAN SC

Facelift Scissors, flat tip, splayed shanks
180mm, 7"

straight	121-328-180
curved	121-329-180

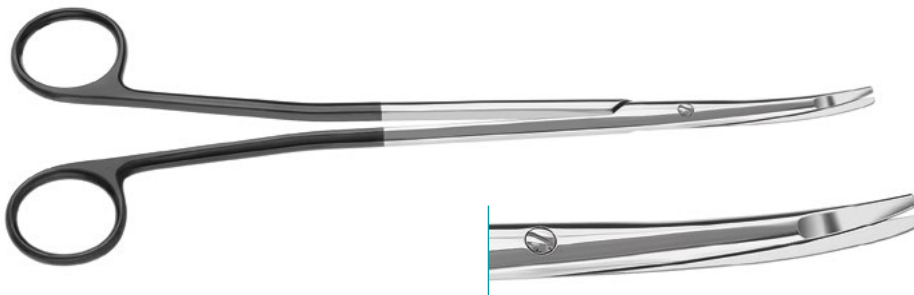

METZENBAUM FREEMAN SC

Rhytidectomy Scissors, flat tip, splayed shanks
curved

180mm, 7"	121-211-180
200mm, 8"	121-211-200
230mm, 9"	121-211-230

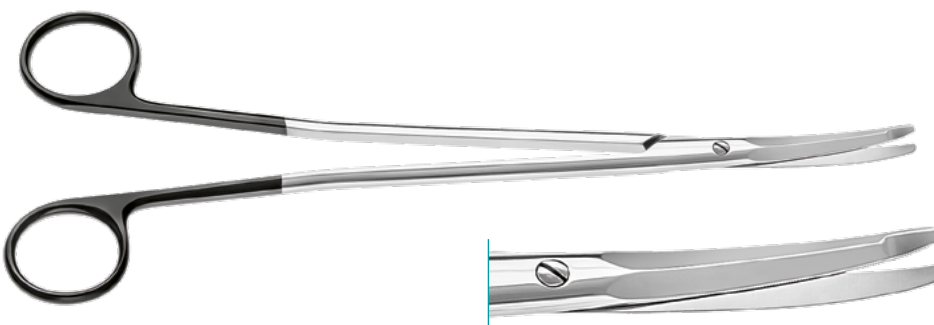

GOURNEY FREEMAN SC

Platysma Scissors, flat tip, curved

230mm, 9"	121-345-230
-----------	-------------



GORNEY SC

Plastic Surgery Scissors, straight

190mm, 7 ¹ / ₂ "	121-336-190
--	-------------

curved

185mm, 7 ¹ / ₄ "	121-337-185
--	-------------

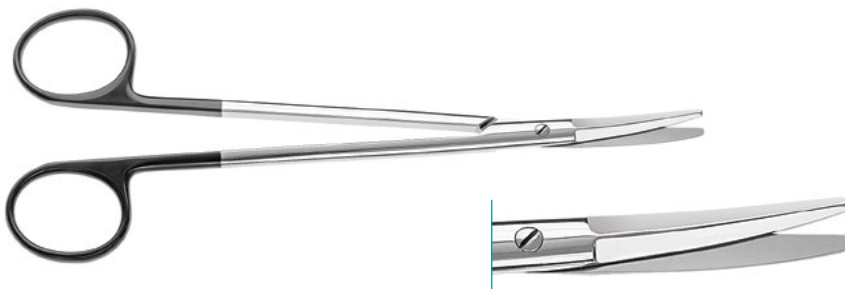

KAYE SC

Facelift Scissors, curved

145mm, 5 ³ / ₄ "	121-327-145
--	-------------

180mm, 7"	121-327-180
-----------	-------------



GORNEY FREEMAN SC

Facelift Scissors, flat tip, splayed shanks

190mm, 7¹/₂"

straight	121-342-190
----------	-------------

curved	121-343-190
--------	-------------

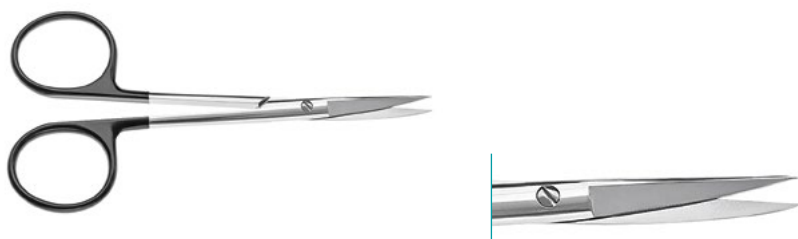
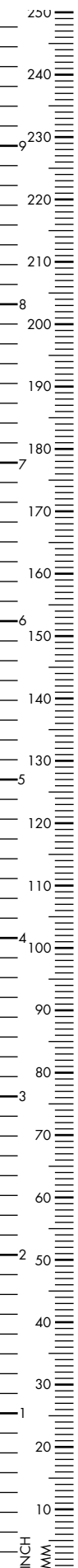

IRIS SC

sharp, 110mm, 4¹/₃"

straight 121-070-110

curved 121-071-110

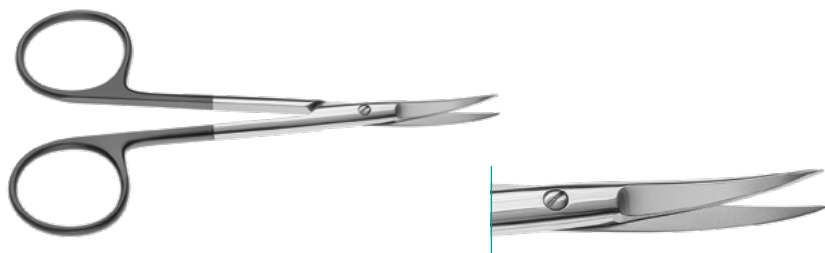

JABALEY SC

curved, with large rings

130mm, 5¹/₈" 121-089-130



JAMESON WERBER SC

curved

135mm, 5¹/₃" 121-313-135



LITTLER SC

with hole, slightly curved, sharp

115mm, 4 ¹ / ₂ "	121-061-115
--	-------------



STEVENS SC

Tenotomy Scissors, square model,
blunt, straight

105mm, 4 ¹ / ₈ "	121-196-100
--	-------------

115mm, 4 ¹ / ₂ "	121-196-110
--	-------------

125mm, 5"	121-196-120
-----------	-------------

curved

105mm, 4 ¹ / ₈ "	121-197-100
--	-------------

115mm, 4 ¹ / ₂ "	121-197-110
--	-------------

125mm, 5"	121-197-120
-----------	-------------



STEVENS SC

curved, sharp/sharp

110mm, 4 ¹ / ₃ "	121-089-110
--	-------------

150mm, 6"	121-089-150
-----------	-------------



GRADLE SC

sharp, curved

120mm, 4 ³ / ₄ "	121-134-120
--	-------------

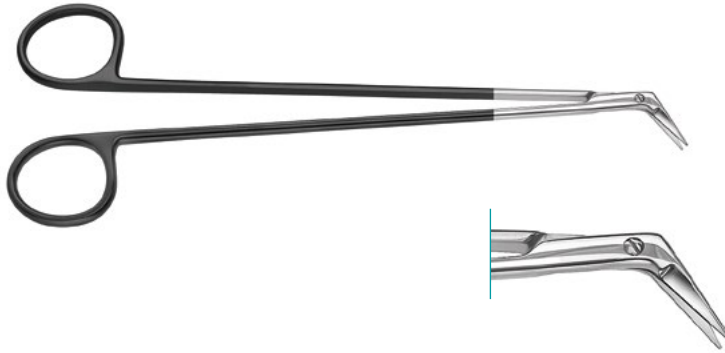

DIETRICH HEGEMANN SC

Vascular Scissors, 13mm standard blade
130mm, 5¹/₈"

25°	126-130-025
45°	126-130-045
60°	126-130-060
90°	126-130-090
125°	126-130-125

180mm, 7"

25°	126-180-025
45°	126-180-045
60°	126-180-060
90°	126-180-090
125°	126-180-125

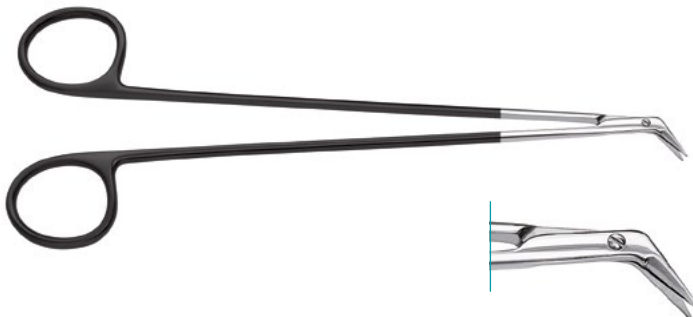

DIETRICH SC

Vascular Scissors, delicate, 9mm short blades
180mm, 7"

25°	126-178-025
45°	126-178-045
60°	126-178-060
90°	126-178-090
125°	126-178-125

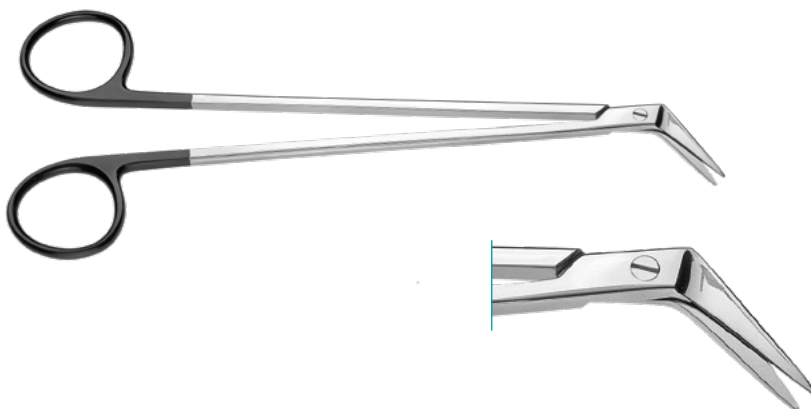

POTTS SMITH SC

Vascular Scissors, 190mm, 7¹/₂"

25°	121-183-190
45°	121-182-190
60°	121-181-190
90°	121-184-190
125°	121-185-190

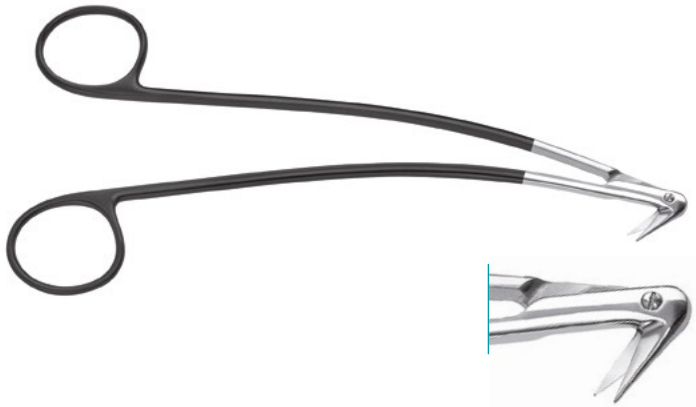

DIETHRICH FAVALORO SC

Vascular Scissors, 13mm standard blades
180mm, 7"

125° 126-185-125

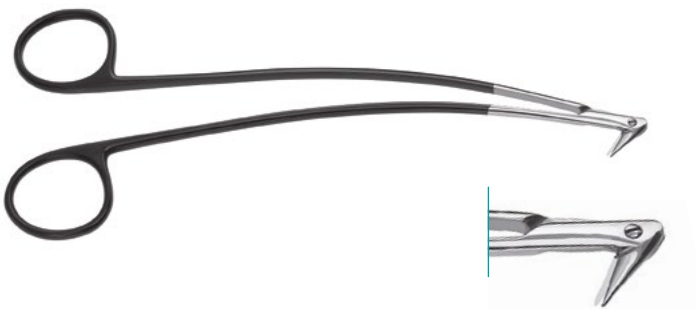

DIETHRICH FAVALORO SC

Vascular Scissors, 9mm short blades
170mm, 6²/₃"

125° 126-168-125

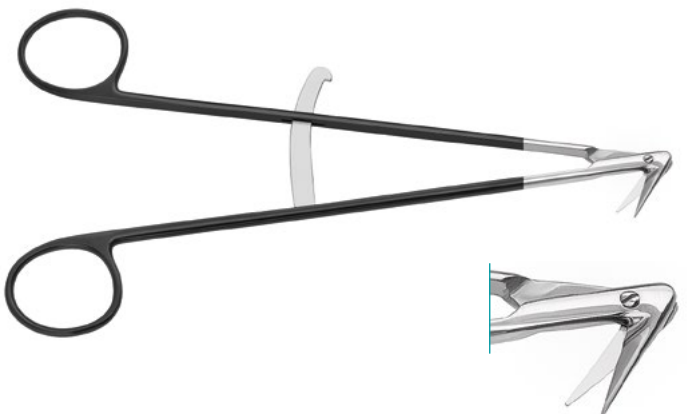

DIETHRICH ARTERY SC

Vascular Scissors, 13mm standard blades
with guide
180mm, 7"

125° 126-200-125

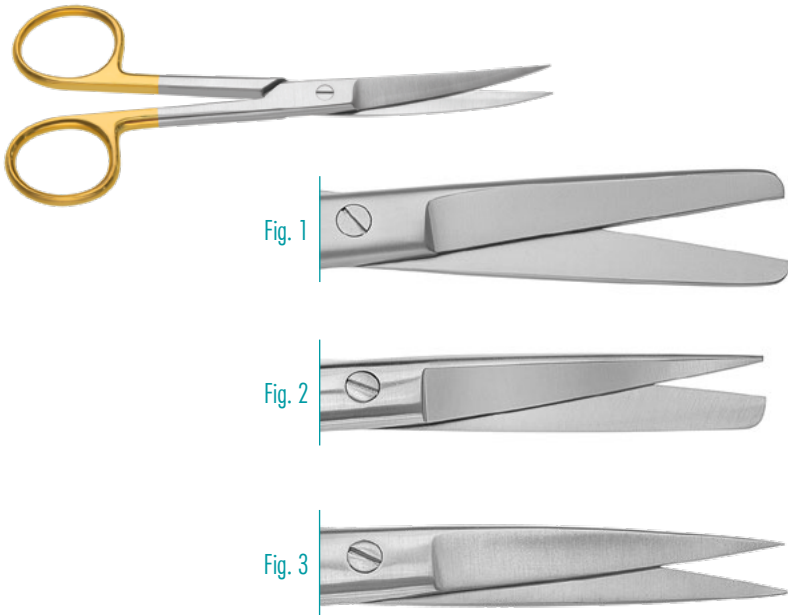

Fig. 1

Fig. 2

Fig. 3

STANDARD TC

straight, 145mm, 5³/₄"

Fig. 1 120-500-145
(blunt/blunt)

curved, 145mm, 5³/₄"

Fig. 1 120-501-145
(blunt/blunt)

straight, 145mm, 5³/₄"

Fig. 2 120-502-145
(sharp/blunt)

Fig. 3 120-504-145
(sharp/sharp)

curved, 145mm, 5³/₄"

Fig. 2 120-503-145
(sharp/blunt)

Fig. 3 120-505-145
(sharp/sharp)

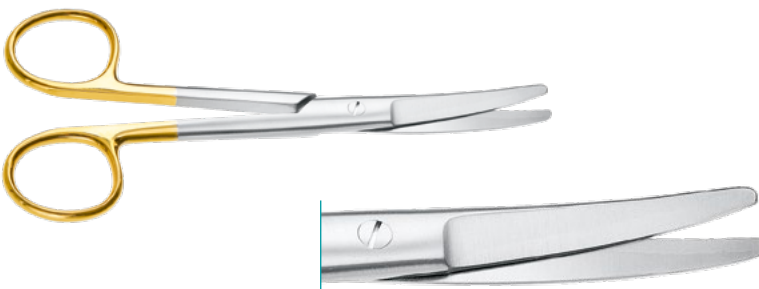

MAYO TC

straight

145mm, 5³/₄" 120-506-145

170mm, 6²/₃" 120-506-170

curved

145mm, 5³/₄" 120-507-145

170mm, 6²/₃" 120-507-170

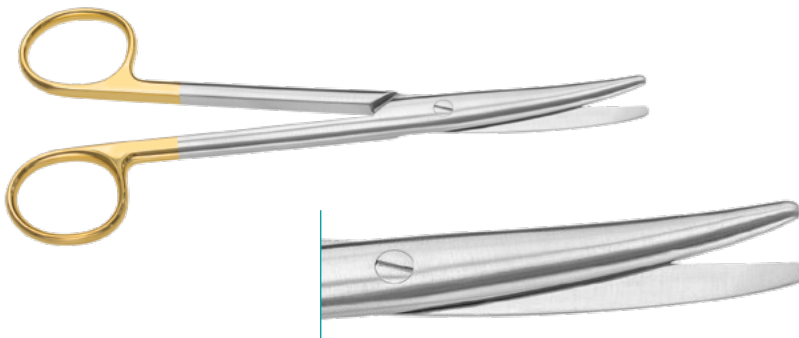

MAYO STILLE TC

straight

150mm, 6" 120-508-150

170mm, 6²/₃" 120-508-170

curved

150mm, 6" 120-509-150

170mm, 6²/₃" 120-509-170



MAYO-HARRINGTON TC

straight

230mm, 9"

120-506-230

curved

230mm, 9"

120-507-230

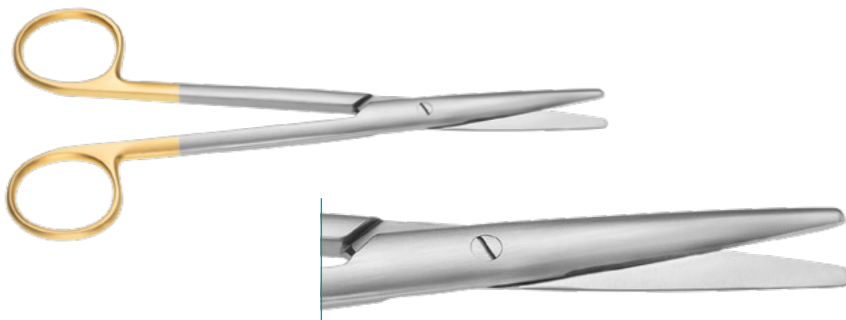

LEXER TC

straight

160mm, 6¹/₄"

120-516-160

210mm, 8¹/₄"

120-516-210

curved

160mm, 6¹/₄"

120-517-160

210mm, 8¹/₄"

120-517-210



TOENNIS ADSON TC

curved

170mm, 6²/₃"

120-531-170

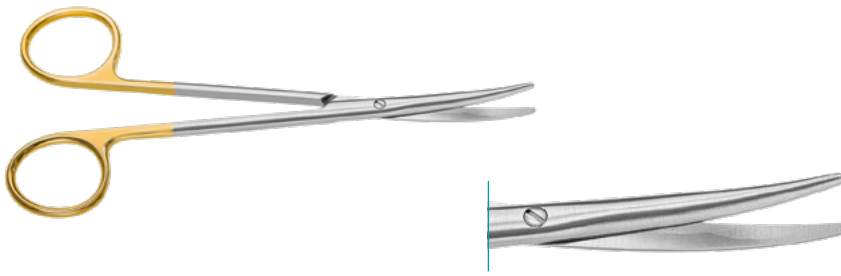

METZENBAUM LAHEY TC

curved, blunt

140mm, 5^{1/2}"

120-530-140

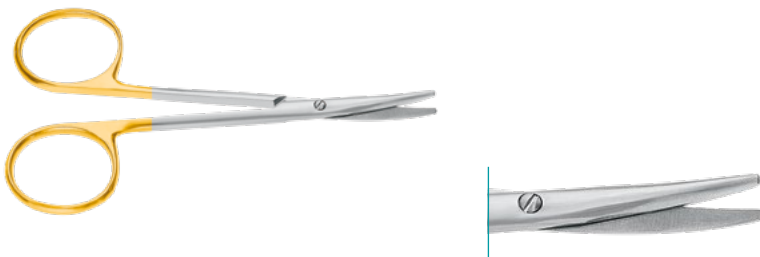

METZENBAUM BABY TC

straight, blunt

115mm, 4^{1/2}"

120-510-115

curved, blunt

115mm, 4^{1/2}"

120-511-115

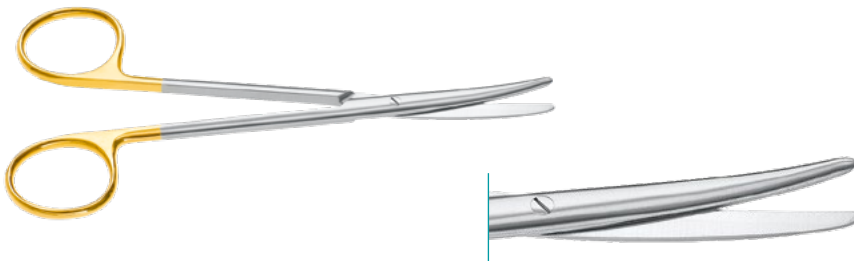

METZENBAUM TC

straight, blunt/blunt

145mm, 5^{3/4}"

120-510-145

180mm, 7"

120-510-180

200mm, 8"

120-510-200

230mm, 9"

120-510-230

curved

145mm, 5^{3/4}"

120-511-145

180mm, 7"

120-511-180

200mm, 8"

120-511-200

230mm, 9"

120-511-230

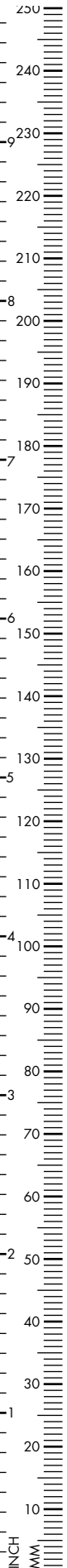

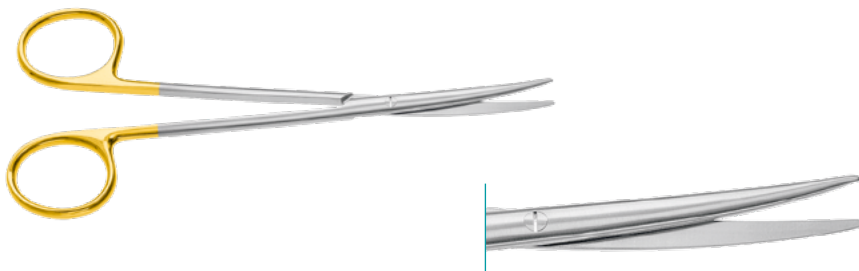

METZENBAUM FINO TC

straight, blunt/blunt

145mm, 5 ³ / ₄ "	120-520-145
180mm, 7"	120-520-180
200mm, 8"	120-520-200
230mm, 9"	120-520-230

curved, blunt/blunt

145mm, 5 ³ / ₄ "	120-521-145
180mm, 7"	120-521-180
200mm, 8"	120-521-200
230mm, 9"	120-521-230

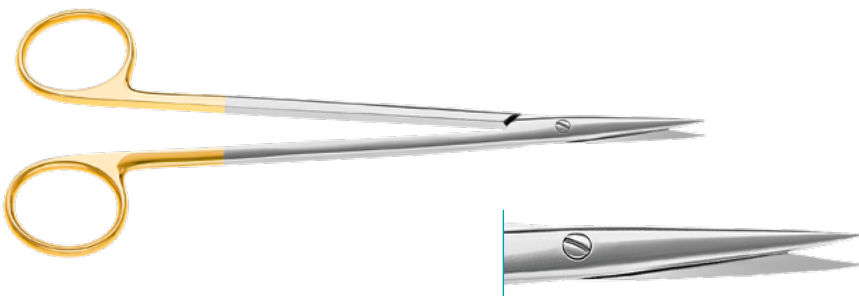

METZENBAUM TC

straight, sharp/sharp

145mm, 5 ³ / ₄ "	120-514-145
180mm, 7"	120-514-180
200mm, 8"	120-514-200
230mm, 9"	120-514-230

curved, sharp/sharp

145mm, 5 ³ / ₄ "	120-515-145
180mm, 7"	120-515-180
200mm, 8"	120-515-200
230mm, 9"	120-515-230

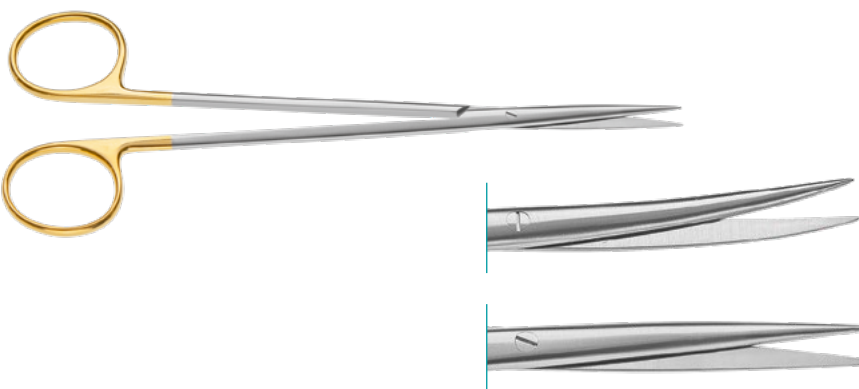

METZENBAUM FINO TC

straight, sharp/sharp

145mm, 5 ³ / ₄ "	120-522-145
180mm, 7"	120-522-180
200mm, 8"	120-522-200
230mm, 9"	120-522-230

curved, sharp/sharp

145mm, 5 ³ / ₄ "	120-523-145
180mm, 7"	120-523-180
200mm, 8"	120-523-200
230mm, 9"	120-523-230

s-curved, blunt

180mm, 7"	120-525-180
200mm, 8"	120-525-200

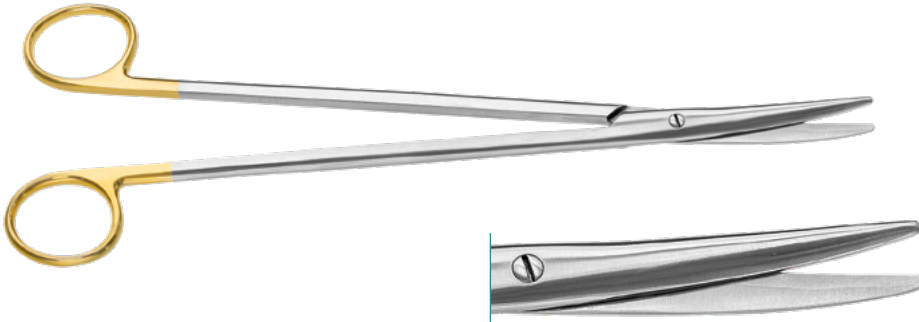

METZENBAUM NELSON TC

straight, Fig.1

250mm, 9 ⁷ / ₈ "	120-510-250
280mm, 11"	120-510-280
300mm, 11 ⁷ / ₈ "	120-510-300

curved, Fig.1

250mm, 9 ⁷ / ₈ "	120-511-250
280mm, 11"	120-511-280
300mm, 11 ⁷ / ₈ "	120-511-300
360mm, 14"	120-511-360

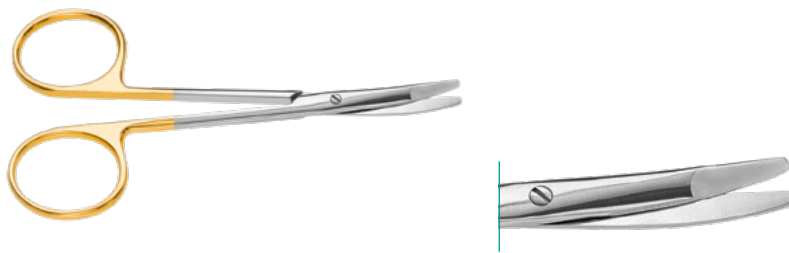

RAGNELL TC

Scissors

120mm, 4 ³ / ₄ "	120-559-120
150mm, 6"	120-559-150
180mm, 7 ¹ / ₂ "	120-559-180



BABY METZENBAUM TC

Strabismus Scissors, straight

115mm, 4 ¹ / ₂ "	120-594-115
--	-------------

curved

115mm, 4 ¹ / ₂ "	120-595-115
--	-------------

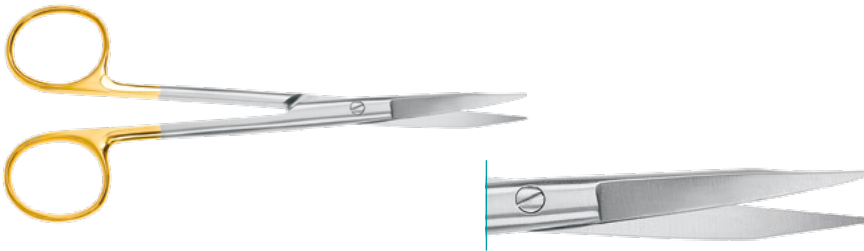

GOLDMAN FOX TC

curved

130mm, 5¹/₈"

120-967-130

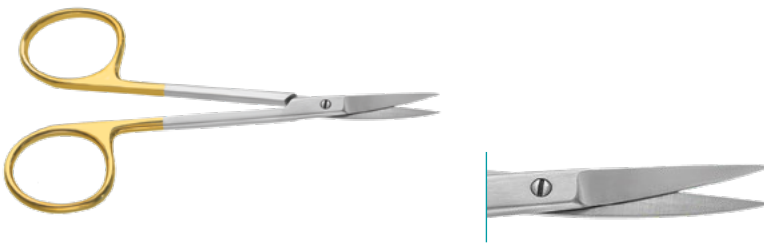

IRIS TC

straight

115mm, 4¹/₂"

120-554-115

curved

115mm, 4¹/₂"

120-555-115

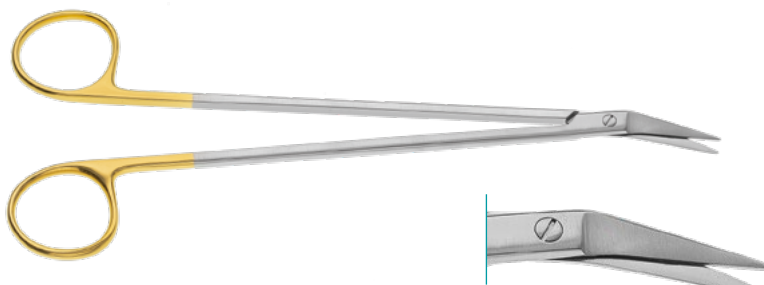

POTTS SMITH TC

Vascular Scissors, 190mm, 7¹/₂"

25° 120-581-190

45° 120-582-190

60° 120-583-190

90° 120-584-190

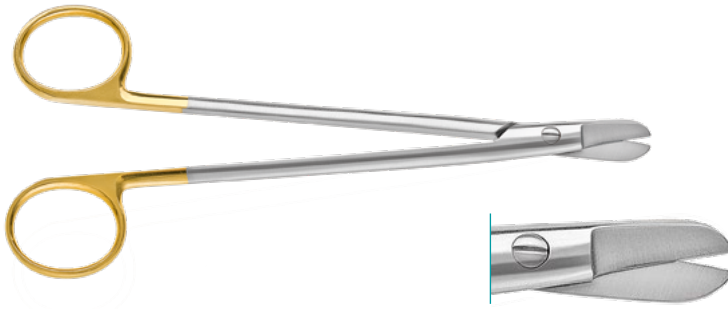
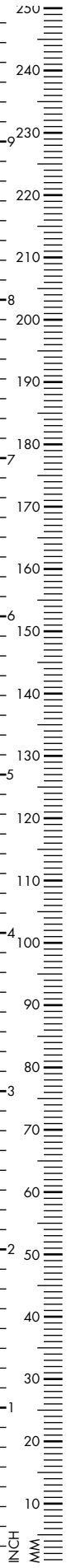

SMITH TC

Wire cutting Scissors, straight

160mm, 6^{1/4}" 120-570-160

curved

160mm, 6^{1/4}" 120-571-160

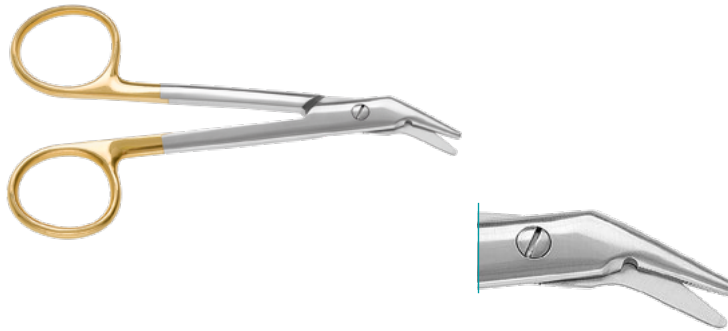

TC Universal Wire Scissors for cutting suture and wire up to 26 gauge and smaller

120mm, 4^{3/4}" 120-565-120



TC Parametrium Scissors, 230mm, 9"

slightly curved 120-537-002

medium curved 120-537-003

angled 120-537-004

265mm, 10^{1/2}"

slightly curved 120-536-002

medium curved 120-536-003

angled 120-536-004

305mm, 12"

slightly curved 120-538-002

medium curved 120-538-003

angled 120-538-004



IRIS CERACUT®
115mm, 4^{1/2}"

straight	123-070-115
curved	123-071-115



STEVENS CERACUT®

Tenotomy Scissors, curved, blunt

100mm, 4"	123-197-100
120mm, 4 ^{3/4} "	123-197-120
150mm, 6"	123-197-150
180mm, 7"	123-092-185
sharp	
110mm, 4 ^{1/3} "	123-197-110



STEVENS CERACUT®

Dissecting Scissors, straight, square rings
115mm, 4^{1/2}"

sharp	123-184-115
blunt	123-182-115

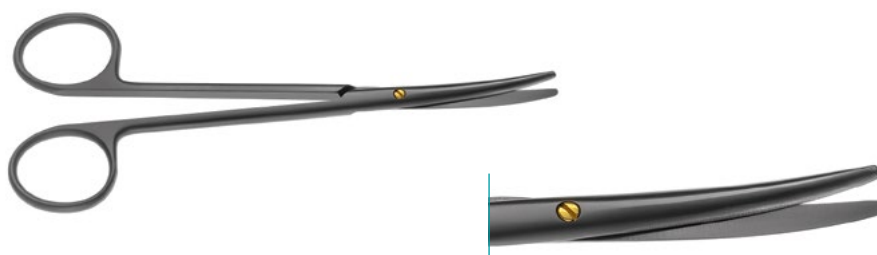

BABY METZENBAUM CERACUT®

curved

110mm, 4 ^{1/3} "	123-317-110
145mm, 5 ^{3/4} "	123-317-145



METZENBAUM NELSON CERACUT®

curved

145mm, 5 ³ / ₄ "	123-111-145
180mm, 7"	123-111-180
200mm, 8"	123-111-200
230mm, 9"	123-111-230



MAYO CERACUT®

straight

145mm, 5 ³ / ₄ "	123-030-145
170mm, 6 ² / ₃ "	123-030-170

curved

145mm, 5 ³ / ₄ "	123-031-145
170mm, 6 ² / ₃ "	123-031-170



MAYO STILLE CERACUT®

170mm, 6²/₃"

straight	123-036-170
curved	123-037-170



MATARASSO TC CERACUT®

Facelift Scissors, curved

170mm, 6 ² / ₃ "	123-305-170
200mm, 8"	123-305-200



GORNEY CERACUT®

Facelift Scissors, serrated, flat tip

190mm, 7¹/₂"

straight	123-584-190
curved	123-585-190

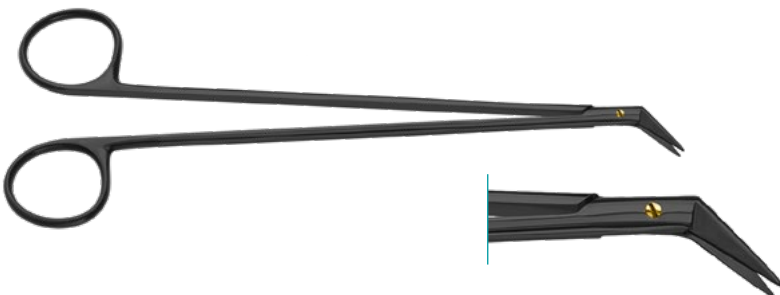

DIETHRICH HEGEMANN CERACUT®

180mm, 7"

45°	123-175-045
60°	123-175-060

