

DRESSING & TISSUE FORCEPS

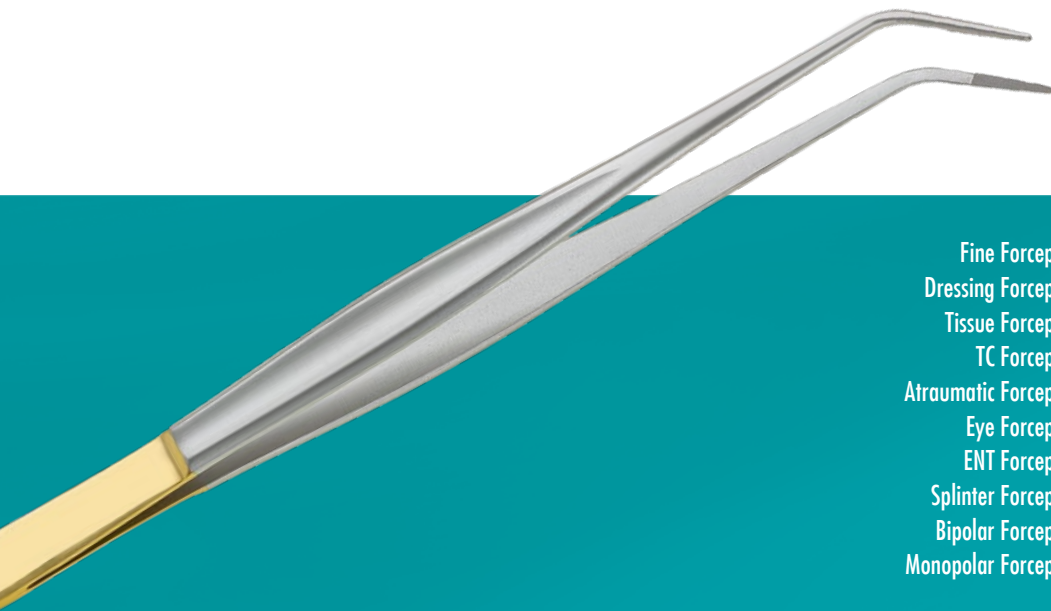

Fine Forceps
Dressing Forceps
Tissue Forceps
TC Forceps
Atraumatic Forceps
Eye Forceps
ENT Forceps
Splinter Forceps
Bipolar Forceps
Monopolar Forceps



Delicate Forceps, smooth, straight

100mm, 4" 130-437-100



Delicate Forceps, smooth, angled

100mm, 4" 130-438-100



Micro Forceps, serrated, 7mm wide handle, straight, tip 0.3mm

130mm, 5¹/₈" 251-612-130



BISHOP HARMON

Iris Forceps, 1x2 teeth, straight,
85mm, 3¹/₃"

0.3mm	400-118-003
-------	-------------

0.4mm	400-118-004
-------	-------------

0.5mm	400-118-005
-------	-------------

0.8mm	400-118-008
-------	-------------

serrated

0.5mm	400-018-005
-------	-------------

0.8mm, cross-serrated	400-019-008
--------------------------	-------------



CASTROVIEJO

Suture Forceps, 1x2 teeth, tying platform,
US handle, 110mm, 4¹/₃"

0.12mm tip	400-137-021
------------	-------------

0.3mm tip	400-137-031
-----------	-------------

0.5mm tip	400-137-055
-----------	-------------

0.9mm tip	400-137-090
-----------	-------------



CASTROVIEJO

Suture Forceps, Diamond dusted, 1x2 teeth,
tying platform, 0.3mm tip

100mm, 4"	400-137-003
-----------	-------------

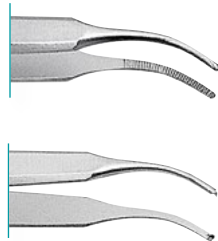
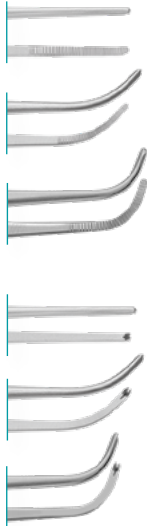
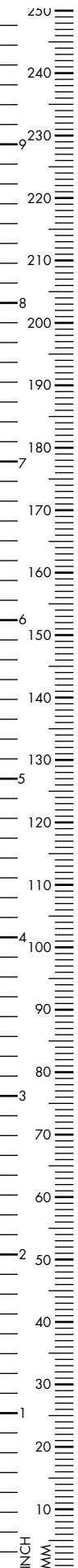

CASTROVIEJO BROWN

Tissue Forceps

9x9 teeth, without platform, US-handle

110mm, 4¹/₃"

400-139-050

GRAEFE

Dressing Forceps, 100mm, 4"

straight 130-500-100

slightly curved 130-501-100

strongly curved 130-502-100

Tissue Forceps, 1x2 teeth

straight 130-503-100

slightly curved 130-504-100

strongly curved 130-505-100

STEVENS

Dressing Forceps, 105mm, 4¹/₈"

slightly curved 130-511-110

Tissue Forceps, 1x2 teeth, 110mm, 4¹/₃"

slightly curved 130-513-110

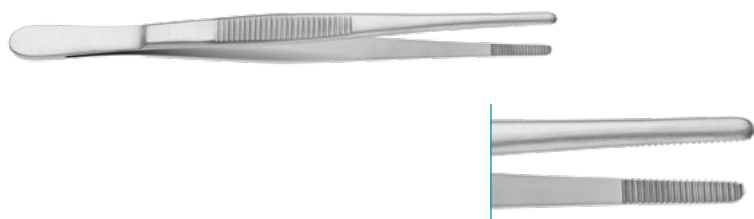

Dressing Forceps, serrated

105mm, 4 ¹ / ₈ "	130-010-105
115mm, 4 ¹ / ₂ "	130-010-115
130mm, 5 ¹ / ₈ "	130-010-130
145mm, 5 ³ / ₄ "	130-010-145
150mm, 6"	130-010-150
160mm, 6 ¹ / ₄ "	130-010-160
180mm, 7"	130-010-180
200mm, 8"	130-010-200
230mm, 9"	130-010-230
250mm, 9 ⁷ / ₈ "	130-010-250
300mm, 11 ⁷ / ₈ "	130-010-300



Dressing Forceps, cross-serrated

130mm, 5 ¹ / ₈ "	130-011-130
145mm, 5 ³ / ₄ "	130-011-145
160mm, 6 ¹ / ₄ "	130-011-160



Standard Dressing Forceps, slender, curved

105mm, 4 ¹ / ₈ "	130-013-105
115mm, 4 ¹ / ₂ "	130-013-115
130mm, 5 ¹ / ₈ "	130-013-130
145mm, 5 ³ / ₄ "	130-013-145

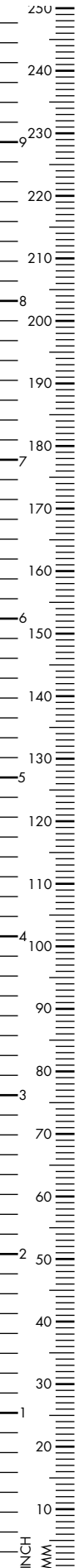

STANDARD

Dressing Forceps, serrated

120mm, 4 ³ / ₄ "	130-046-120
130mm, 5 ¹ / ₈ "	130-046-130
145mm, 5 ³ / ₄ "	130-046-145
180mm, 7"	130-046-180
200mm, 8"	130-046-200



STANDARD

Dressing Forceps, delicate tip, serrated

105mm, 4 ¹ / ₈ "	130-012-105
115mm, 4 ¹ / ₂ "	130-012-115
130mm, 5 ¹ / ₈ "	130-012-130
145mm, 5 ³ / ₄ "	130-012-145
160mm, 6 ¹ / ₄ "	130-012-160
180mm, 7"	130-012-180
200mm, 8"	130-012-200
250mm, 9 ⁷ / ₈ "	130-012-250
300mm, 11 ⁷ / ₈ "	130-012-300



Standard Dressing Forceps, delicate tip, serrated, straight

105mm, 4 ¹ / ₈ "	130-014-105
115mm, 4 ¹ / ₂ "	130-014-115
130mm, 5 ¹ / ₈ "	130-014-130
145mm, 5 ³ / ₄ "	130-014-145
250mm, 9 ⁷ / ₈ "	130-014-250



Standard Dressing Forceps, delicate tip, serrated, curved

105mm, 4 ¹ / ₈ "	130-015-105
115mm, 4 ¹ / ₂ "	130-015-115
130mm, 5 ¹ / ₈ "	130-015-130
145mm, 5 ³ / ₄ "	130-015-145

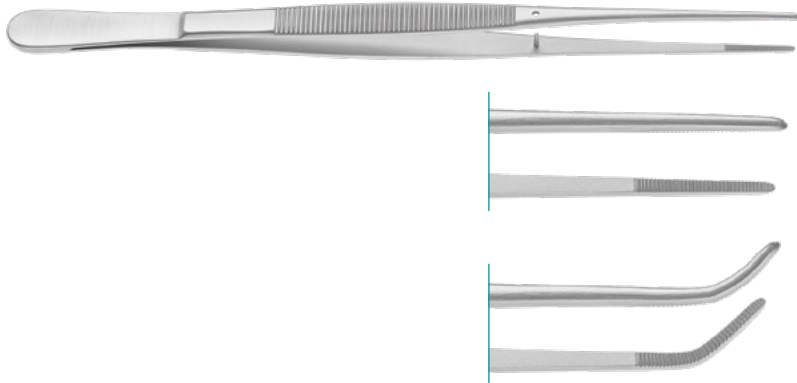

POTTS SMITH

Dressing Forceps, straight

180mm, 7" 130-038-180

210mm, 8^{1/4}" 130-038-210

250mm, 9^{7/8}" 130-038-250

curved

180mm, 7" 130-037-180

210mm, 8^{1/4}" 130-037-210

250mm, 9^{7/8}" 130-037-250



EWALD ADSON

Dressing Forceps, 1.5mm tip, serrated

120mm, 4^{3/4}" 130-021-120

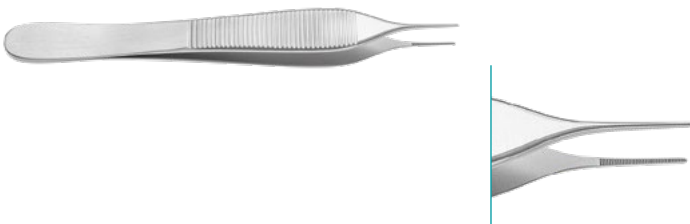

YANG ADSON

Dressing Forceps, serrated, 0.5mm tip

120mm, 4^{3/4}" 130-540-120

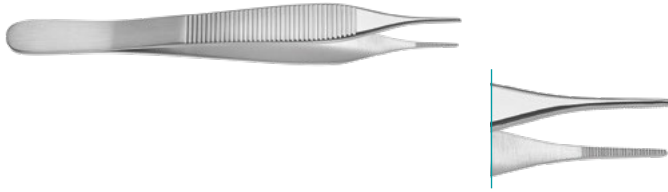
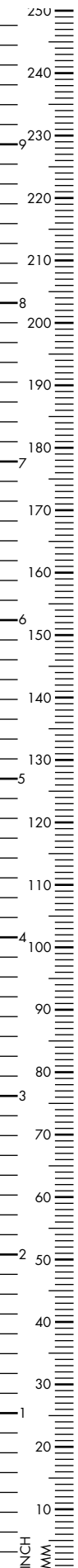

MICRO ADSON

Dressing Forceps, serrated

120mm, 4 ³ / ₄ "	130-548-120
--	-------------

150mm, 6"	130-548-150
-----------	-------------



ADSON

Dressing Forceps, smooth

120mm, 4 ³ / ₄ "	130-025-120
--	-------------



ADSON

Dressing Forceps, serrated

120mm, 4 ³ / ₄ "	130-026-120
--	-------------

150mm, 6"	130-026-150
-----------	-------------

180mm, 7"	130-026-180
-----------	-------------



ADSON

Dressing Forceps, cross-serrated

120mm, 4 ³ / ₄ "	130-029-120
--	-------------



BROPHY

Dressing Forceps, straight, serrated

200mm, 8"	130-042-200
-----------	-------------

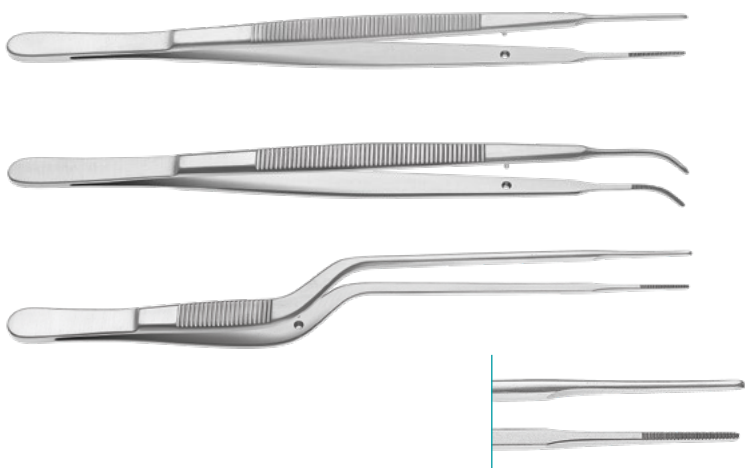

GERALD

Dressing Forceps, narrow,
1.2mm step-down-tip, serrated

Straight, 180mm, 7"	130-034-180
Straight, 230mm, 9"	130-034-230
Curved, 180mm, 7"	130-035-180
Curved, 230mm, 9"	130-035-230
Bayonet, 190mm, 7 ¹ / ₂ "	130-041-180



GERALD

Diamond Dusted Dressing Forceps, narrow,
1.0mm step-down-tip

180mm, 7"	130-022-180
200mm, 8"	130-022-200



SEMKEN

Dressing Forceps, cross-serrated

125mm, 5" 130-144-125

150mm, 6" 130-144-150



TAYLOR

Dressing Forceps, bayonet,
serrated with dissector end

185mm, 7^{1/4}" 130-035-185



TAYLOR

Dressing Forceps, serrated with dissector end

175mm, 6^{7/8}" 130-030-175

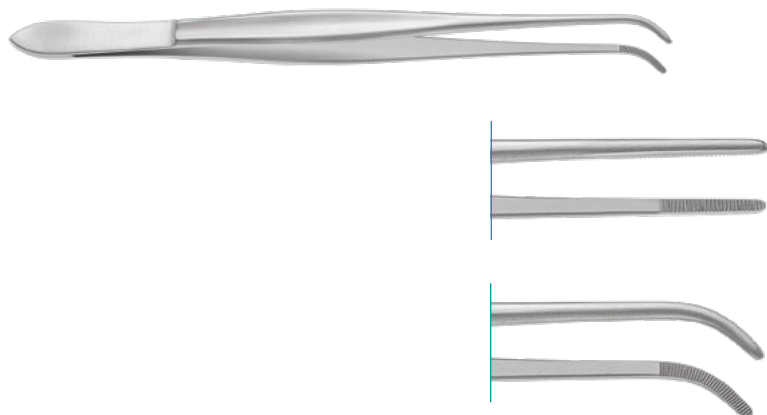

CUSHING

Dressing Forceps, serrated, fluted handle, straight

175mm, 6 ^{7/8} "	130-036-175
---------------------------	-------------

curved

175mm, 6 ^{7/8} "	130-037-175
---------------------------	-------------



MCINDOE

Dressing Forceps, serrated, US handle

150mm, 6"	130-028-150
-----------	-------------



WAUGH

Dressing Forceps, cross-serrated

150mm, 6"	130-162-150
-----------	-------------

200mm, 8"	130-162-200
-----------	-------------

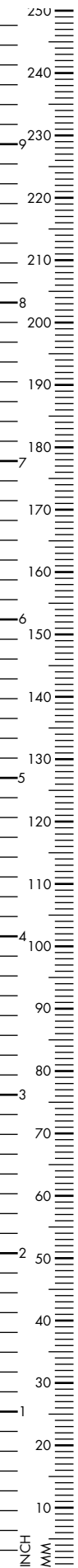

ADSON

Tissue Forceps, 1x2 teeth

120mm, 4³/₄" 130-140-120

150mm, 6" 130-140-150

180mm, 7" 130-140-180

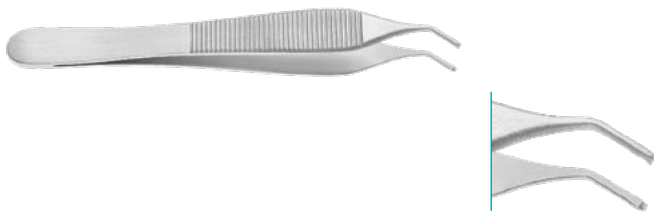

ADSON

Tissue Forceps, 1x2 teeth, angled

120mm, 4³/₄" 130-143-120

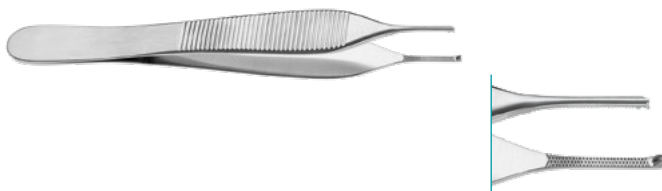

ADSON

Tissue Forceps, 1x2 teeth, cross-serrated

120mm, 4³/₄" 130-557-120



MICRO ADSON

Tissue Forceps, 1x2 teeth, 0.8mm tip

120mm, 4 ³ / ₄ "	130-550-120
--	-------------

150mm, 6"	130-550-150
-----------	-------------



ADSON

Tissue Forceps, 1x2 teeth, with tying platform

120mm, 4³/₄"

0.9mm tip	130-141-009
-----------	-------------

1.0mm tip	130-141-010
-----------	-------------

1.2mm tip	130-141-012
-----------	-------------



EWALD ADSON

Tissue Forceps, 1x2 teeth

120mm, 4 ³ / ₄ "	130-142-120
--	-------------

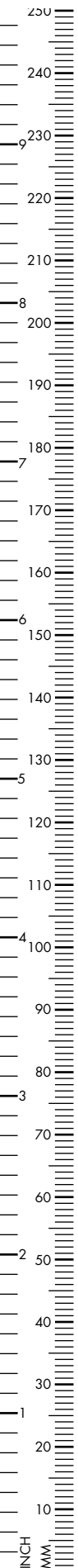

YANG ADSON

Tissue Forceps, straight, 90° 1x2 teeth,
tip 0.3mm

120mm, 4³/₄"

130-554-120



ADSON

Tissue Forceps, 2x3 teeth

120mm, 4³/₄"

130-555-120

150mm, 6"

130-555-150

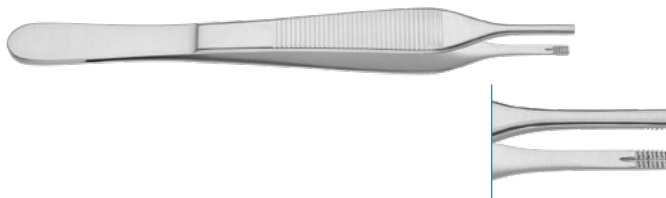

ADSON BROWN

Tissue Forceps, 7x7 teeth

120mm, 4³/₄"

130-552-120

150mm, 6"

130-552-150

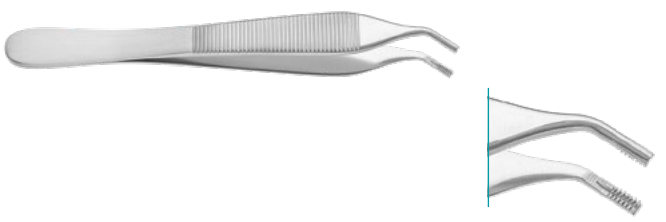

ADSON BROWN

Tissue Forceps, 7x7 teeth, angled

120mm, 4³/₄"

130-556-120



BROWN

Tissue Forceps, 7x7 teeth

160mm, 6 ¹ / ₄ "	130-554-160
200mm, 8"	130-554-200
250mm, 9 ⁷ / ₈ "	130-554-250

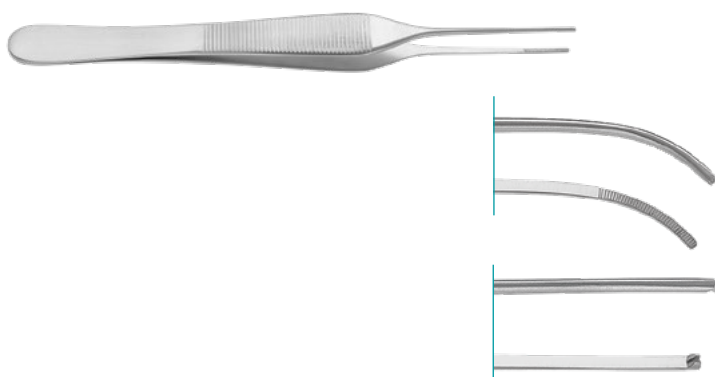

BROLI ADSON

Tissue Forceps, 1.2mm tip, 150mm, 6"

Straight, serrated tip	130-024-151
Curved, serrated tip	130-024-152
Straight, diamond dusted tip	130-024-153
Straight, 1x2 teeth	130-024-154



Tissue Forceps, 1x2 teeth

105mm, 4 ¹ / ₈ "	130-110-105
115mm, 4 ¹ / ₂ "	130-110-115
130mm, 5 ¹ / ₈ "	130-110-130
145mm, 5 ³ / ₄ "	130-110-145
150mm, 6"	130-110-150
160mm, 6 ¹ / ₄ "	130-110-160
180mm, 7"	130-110-180
200mm, 8"	130-110-200
230mm, 9"	130-110-230
250mm, 9 ⁷ / ₈ "	130-110-250
300mm, 11 ⁷ / ₈ "	130-110-300

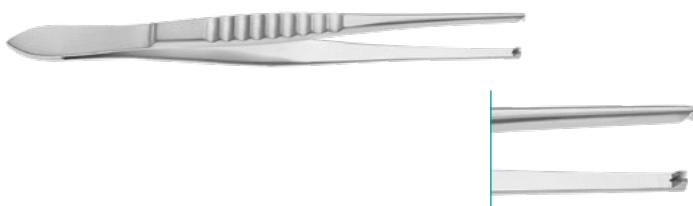

Tissue Forceps, 1x2 teeth, US model

120mm, 4 ³ / ₄ "	130-126-120
145mm, 5 ³ / ₄ "	130-126-145
150mm, 6"	130-126-155



Tissue Forceps, 1x2 teeth, delicate

115mm, 4 ¹ / ₂ "	130-120-115
130mm, 5 ¹ / ₈ "	130-120-130
145mm, 5 ³ / ₄ "	130-120-145
160mm, 6 ¹ / ₄ "	130-120-160
180mm, 7"	130-120-180
200mm, 8"	130-120-200
250mm, 9 ⁷ / ₈ "	130-120-250
300mm, 11 ⁷ / ₈ "	130-120-300



Tissue Forceps

2x3teeth, 145mm, 5 ³ / ₄ "	130-112-145
2x3teeth, 160mm, 6 ¹ / ₄ "	130-112-160
3x4teeth, 145mm, 5 ³ / ₄ "	130-114-145
3x4teeth, 160mm, 6 ¹ / ₄ "	130-114-160
4x5teeth, 145mm, 5 ³ / ₄ "	130-116-145
4x5teeth, 160mm, 6 ¹ / ₄ "	130-116-160



Tissue Forceps, 1x2 teeth, delicate

145mm, 5 ³ / ₄ "	130-118-145
155mm, 6 ¹ / ₈ "	130-118-155
160mm, 6 ¹ / ₄ "	130-118-160
180mm, 7"	130-118-180

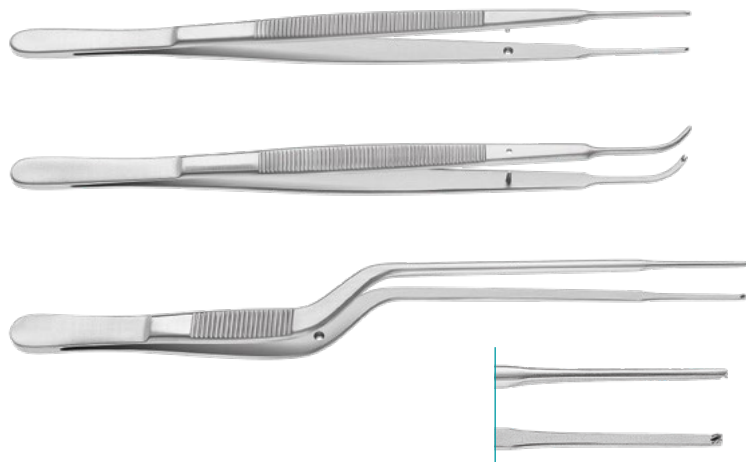

GERALD

Tissue Forceps, narrow, 1.3mm step-down tip
1x2 teeth

Straight, 180mm, 7"	130-150-180
Straight, 230mm, 9"	130-150-230
Curved, 180mm, 7"	130-151-180
Bayonet, 195mm, 7 ³ / ₄ "	130-153-195



SEMKEN

Tissue Forceps

1x2teeth, 125mm, 5"	130-145-125
1x2teeth, 150mm, 6"	130-145-150
2x3teeth, 125mm, 5"	130-147-125

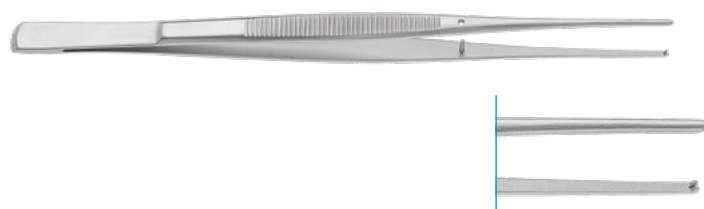

TAYLOR

Tissue Forceps, 1x2 teeth, dissector end

175mm, 6 ⁷ / ₈ "	130-147-175
--	-------------



TAYLOR

Tissue Forceps, 1x2 teeth, bayonet,
dissector end

175mm, 6 ⁷ / ₈ "	130-157-175
--	-------------

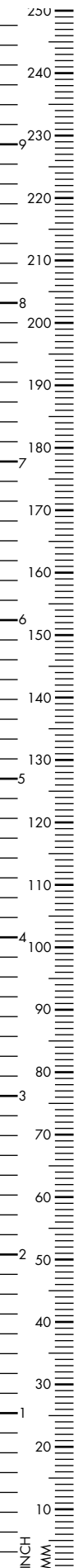

CUSHING

Tissue Forceps, 175mm, 6⁷/₈"

straight	130-152-175
curved	130-153-175



GILLIES

Tissue Forceps, 1x2 teeth, cross-serrated

150mm, 6"	130-120-150
-----------	-------------



WAUGH

Tissue Forceps, 1x2 teeth, cross-serrated

150mm, 6"	130-160-150
200mm, 8"	130-160-200



BEASLEY BABCOCK

Tissue Forceps, 5x6 teeth, straight

125mm, 5"	130-561-125
-----------	-------------

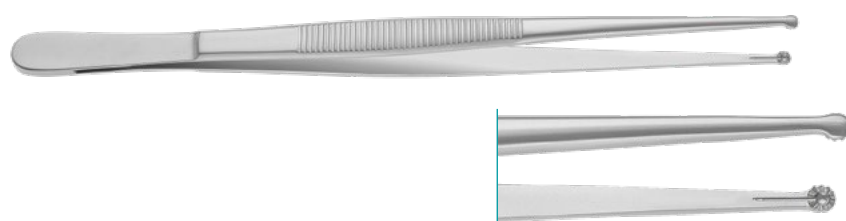

SELMAN

Tissue Forceps, 3.8mm round, serrated cup

150mm, 6"	130-644-150
-----------	-------------

200mm, 8"	130-644-200
-----------	-------------

250mm, 9 ⁷ / ₈ "	130-644-250
--	-------------

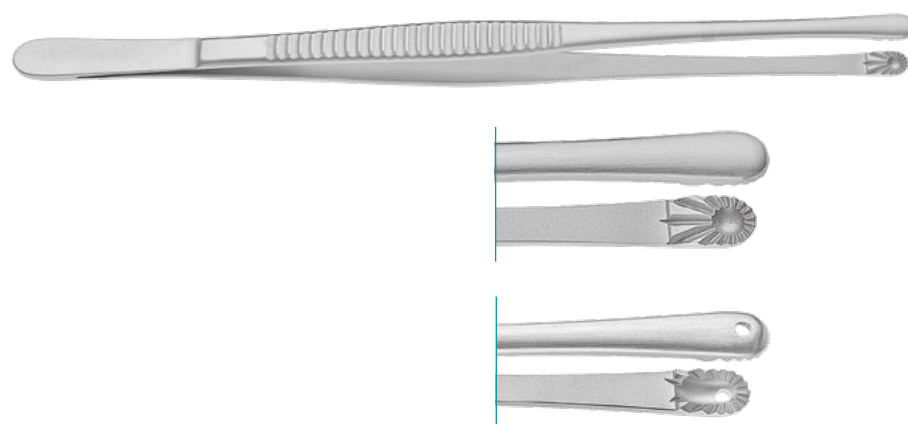

RUSSIAN

Tissue Forceps

150mm, 6"	130-510-150
-----------	-------------

200mm, 8"	130-510-200
-----------	-------------

250mm, 9 ⁷ / ₈ "	130-510-250
--	-------------

300mm, 11 ⁷ / ₈ "	130-510-300
---	-------------

350mm, 14"	130-510-350
------------	-------------

MAYO RUSSIAN

Tissue Forceps

230mm, 9"	130-456-230
-----------	-------------

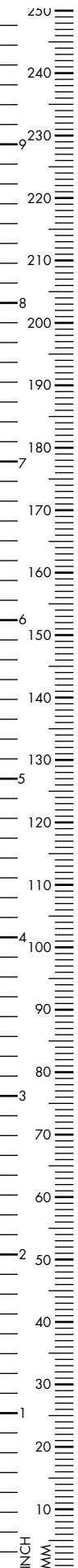

BONNEY

Tissue Forceps, 1x2 teeth

180mm, 7" 130-143-180



ADLERKREUTZ

Tissue Forceps, serrated, 2x3 teeth

150mm, 6" 130-137-150

200mm, 8" 130-137-200

4x5 teeth

150mm, 6" 130-138-150

200mm, 8" 130-138-200



POTTS SMITH

Tissue Forceps, 1x2 teeth, straight

180mm, 7" 130-154-180

210mm, 8^{1/4}" 130-154-210

250mm, 9^{7/8}" 130-154-250

curved

180mm, 7" 130-155-180

210mm, 8^{1/4}" 130-155-210

250mm, 9^{7/8}" 130-155-250



CUSHING BROWN

Tissue Forceps, 9x9 teeth, dissector end

175mm, 6^{7/8}" 130-554-175



CUSHING BROWN

Tissue Forceps, 9x9 teeth, bayonet, dissector end

180mm, 7"	130-555-180
-----------	-------------

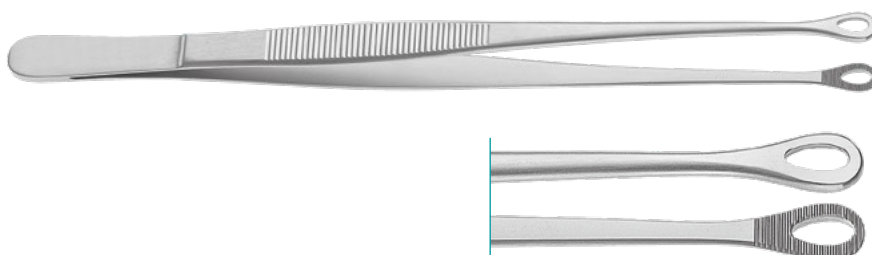

SINGLEY TUTTLE

Lung Grasping Forceps, serrated

150mm, 6"	130-560-150
180mm, 7"	130-560-180
230mm, 9"	130-560-230
350mm, 14"	130-560-350

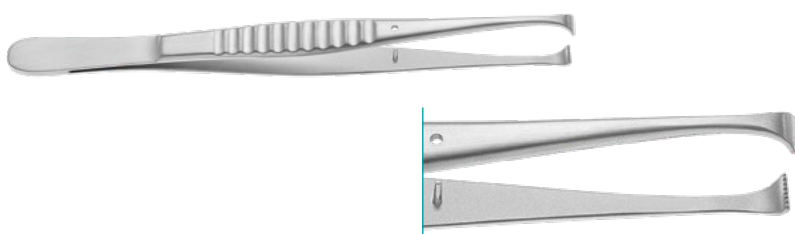

NELSON

Tissue Forceps, 6x7 teeth

150mm, 6"	130-562-150
200mm, 8"	130-562-200
230mm, 9"	130-562-230

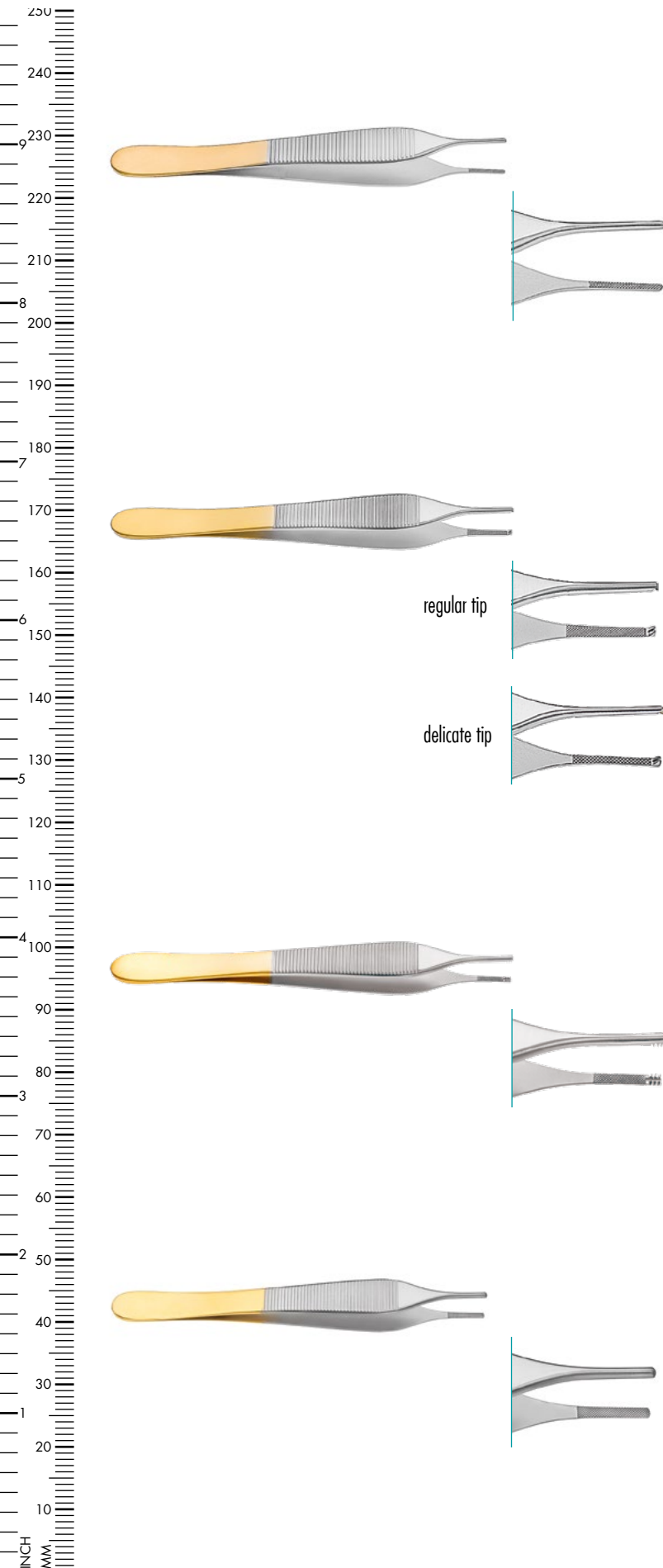

TC MICRO ADSON

Dressing Forceps, serrated

120mm, 4 ³ / ₄ "	130-538-120
--	-------------

TC ADSON

Needle and Tissue Pulling Forceps, with tying platform, 1x2 teeth, cross-serrated, regular tip

120mm 4 ³ / ₄ "	130-534-120
---------------------------------------	-------------

150mm, 6"	130-534-150
-----------	-------------

delicate tip

120mm 4 ³ / ₄ "	130-537-120
---------------------------------------	-------------

150mm, 6"	130-537-150
-----------	-------------

TC ADSON BROWN

Tissue Forceps, 7x7 teeth, tying platform

120mm, 4 ³ / ₄ "	130-529-120
--	-------------

150mm, 6"	130-529-150
-----------	-------------

TC ADSON

Dressing Forceps, serrated

120mm, 4 ³ / ₄ "	130-532-120
--	-------------

150mm, 6"	130-532-150
-----------	-------------

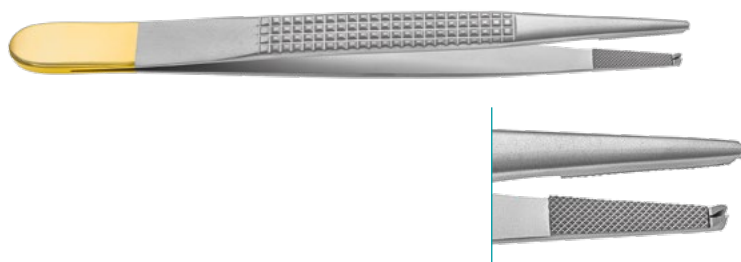

TC BONNEY

Needle and Tissue Pulling Forceps,
with tying platform, 1x2 teeth

170mm, 6 ² / ₃ "	130-514-170
--	-------------



TC FERRIS SMITH

Needle and Tissue Pulling Forceps,
with tying platform, 1x2 teeth

170mm, 6 ² / ₃ "	130-510-170
--	-------------



TC OEHLER

Needle and Tissue Pulling Forceps,
with tying platform, 1x2 teeth

160mm, 6 ¹ / ₄ "	130-522-160
--	-------------

200mm, 8"	130-522-200
-----------	-------------

250mm, 9 ⁷ / ₈ "	130-522-250
--	-------------



TC GERALD

Needle and Tissue Pulling Forceps,
with tying platform, 1x2 teeth

170mm, 6 ² / ₃ "	130-518-170
--	-------------

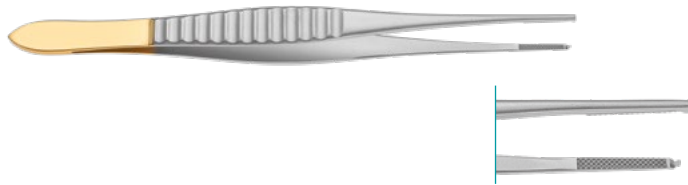
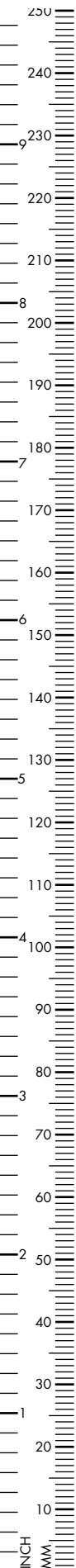

TC GILLIES

Dissecting Forceps, with tying platform,
1x2 teeth

150mm, 6"	130-520-150
-----------	-------------

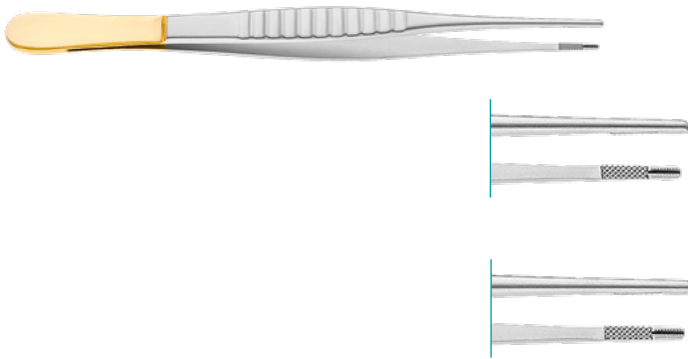

TC DEBAKEY

Needle and Tissue Pulling Forceps, atraumatic,
2.0mm tip

160mm, 6 ¹ / ₄ "	130-570-160
200mm, 8"	130-570-200
240mm, 9 ¹ / ₂ "	130-570-240

1.5mm tip

160mm, 6 ¹ / ₄ "	130-568-150
200mm, 8"	130-568-190
240mm, 9 ¹ / ₂ "	130-568-240

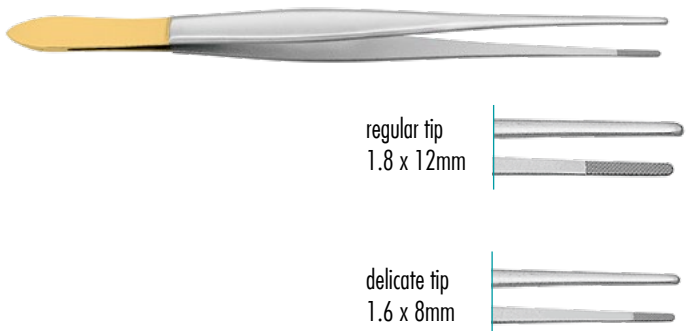

TC CUSHING

Needle and Tissue Pulling Forceps,
with scraper/dissector end, regular tip

175mm, 6 ⁷ / ₈ "	130-536-175
--	-------------

delicate tip

175mm 6 ⁷ / ₈ "	130-538-175
---------------------------------------	-------------



TC SEMKEN

Dressing Forceps

150mm, 6"	130-512-150
-----------	-------------



TC Dressing Forceps

145mm, 5³/₄" 130-518-145

160mm, 6¹/₄" 130-518-160



TC GERALD

Dressing Forceps, narrow step-down-tip

170mm, 6²/₃" 130-516-170



TC CUSHING

Needle and Tissue Pulling Forceps, angled

180mm, 7" 130-539-180



TC MCINDOE

Dissecting Forceps

150mm, 6" 130-522-150

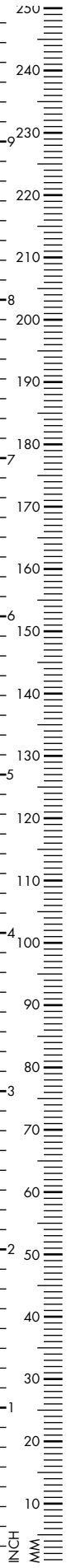

TC CUSHING TAYLOR

Dressing Forceps, bayonet, with dissector end

180mm, 7" 130-541-180

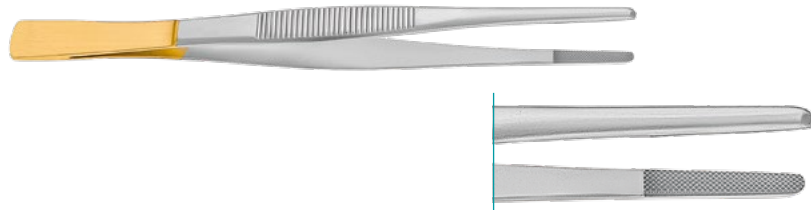

TC POTTS SMITH

Dressing Forceps, cross-serrated, with dissector end

150mm, 6" 130-542-150

180mm, 7" 130-542-180

210mm, 8¹/₄" 130-542-210

230mm, 9" 130-542-230

250mm, 9⁷/₈" 130-542-250

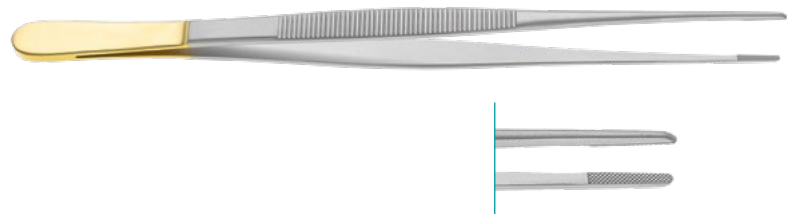

TC REUL

Coronary Dressing Forceps, 1.6mm wide x 12mm

195mm, 7³/₄" 130-544-195

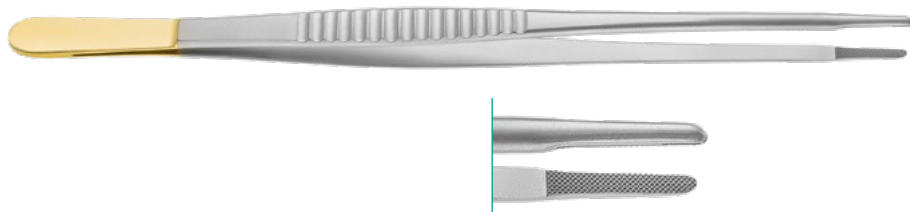

TC EVANS

Dressing Forceps, cross-serrated

250mm, 9⁷/₈" 130-575-250

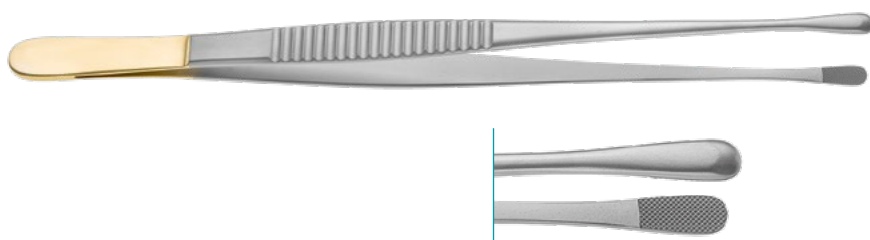

TC WANGENSTEEN

Dressing Forceps

150mm, 6" 130-566-150

230mm, 9" 130-566-230

250mm, 9⁷/₈" 130-566-250



COOLEY

Straight, delicate, 1.2mm tip

200mm, 8" 130-049-200

250mm, 9⁷/₈" 130-049-250

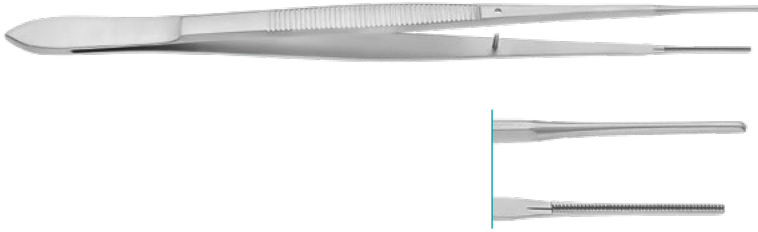

GERALD DEBAKEY

Vascular Tissue Forceps, straight, extra delicate
1.0mm tip, DeBakey serrations

175mm, 6 ^{7/8} "	130-520-175
200mm, 8"	130-520-200
240mm, 9 ^{1/2} "	130-520-240

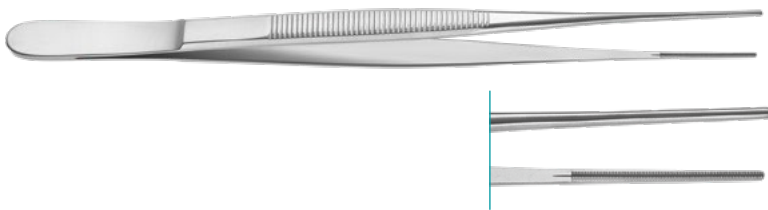

DIETHRICH DEBAKEY

Vascular Tissue Forceps, straight, extra delicate
1.5mm tip, 20mm DeBakey serrations

160mm, 6 ^{1/4} "	130-468-150
200mm, 8"	130-468-200
240mm, 9 ^{1/2} "	130-468-240

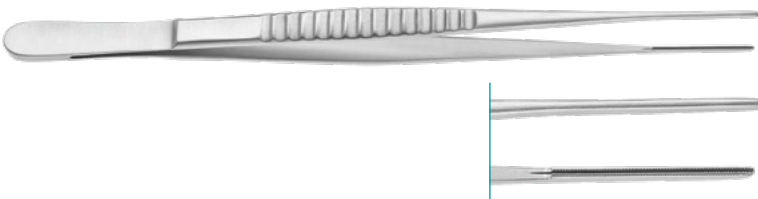

DIETHRICH DEBAKEY

Vascular Tissue Forceps, straight, extra delicate
1.5mm tip, 24mm DeBakey serrations

160mm, 6 ^{1/4} "	290-550-160
200mm, 8"	290-550-200
240mm, 9 ^{1/2} "	290-550-240
300mm, 11 ^{7/8} "	290-550-300



DEBAKEY

Vascular Atraumatic Forceps, straight, 2.0mm tip, 24mm DeBakey serrations

160mm, 6 ¹ / ₄ "	290-552-160
200mm, 8"	290-552-200
240mm, 9 ¹ / ₂ "	290-552-240
300mm, 11 ⁷ / ₈ "	290-552-300

angled

160mm, 6 ¹ / ₄ "	290-553-160
200mm, 8"	290-553-200
240mm, 9 ¹ / ₂ "	290-553-240
300mm, 11 ⁷ / ₈ "	290-553-300



DEBAKEY

Vascular Atraumatic Forceps, straight, 2.4mm tip, 24mm DeBakey serrations

160mm, 6 ¹ / ₄ "	290-557-160
200mm, 8"	290-557-200
240mm, 9 ¹ / ₂ "	290-557-240
300mm, 11 ⁷ / ₈ "	290-557-300

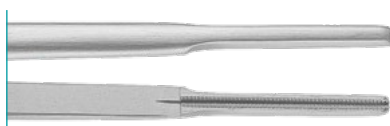
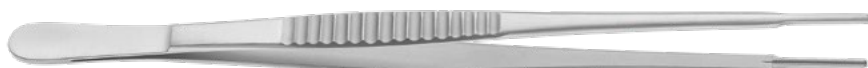

DEBAKEY

Vascular Atraumatic Forceps, straight, 2.8mm step-down tip, 24mm DeBakey serrations

160mm, 6 ¹ / ₄ "	290-558-160
200mm, 8"	290-558-200
240mm, 9 ¹ / ₂ "	290-558-240
300mm, 11 ⁷ / ₈ "	290-558-300

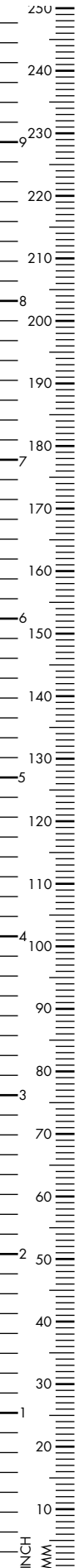

DEBAKEY

Vascular Atraumatic Forceps, straight,
3.5mm step-down tip,
24mm DeBakey serrations

160mm, 6 ¹ / ₄ "	290-555-160
200mm, 8"	290-555-200
240mm, 9 ¹ / ₂ "	290-555-240
300mm, 11 ⁷ / ₈ "	290-555-300



COOLEY

Vascular Atraumatic Forceps, straight,
delicate 1.5mm tip,
24mm Cooley serrations

150mm, 6"	290-556-150
2.0mm tip	
160mm, 6 ¹ / ₄ "	290-556-160
200mm, 8"	290-556-200
240mm, 9 ¹ / ₂ "	290-556-240



ADSON DEBAKEY

Vascular Atraumatic Forceps,
straight, 2.0mm tip

120mm, 4 ³ / ₄ "	130-527-120
--	-------------



Plain Splinter Forceps

90mm, 3 ¹ / ₂ "	130-622-090
115mm, 4 ¹ / ₂ "	130-622-115



FEILCHENFELD

Splinter Forceps

80mm, 3 ¹ / ₈ "	130-630-075
90mm, 3 ¹ / ₂ "	130-630-090
115mm, 4 ¹ / ₂ "	130-630-115



CARMALT

Splinter Forceps, 105mm, 4¹/₈"

Straight	130-632-105
Curved	130-633-105

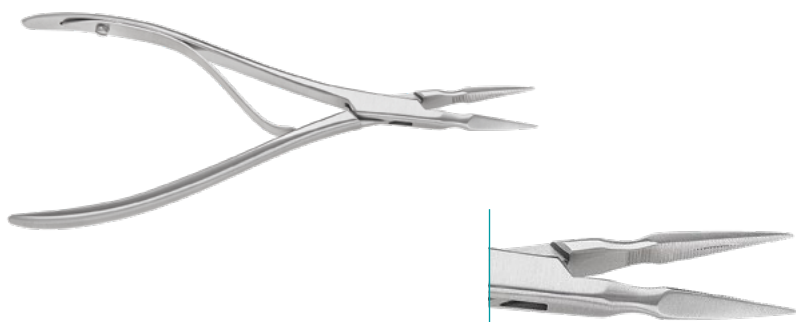

VIRTUS

Splinter Forceps

140mm, 5 ¹ / ₂ "	130-640-140
--	-------------



GRAEFE

Fixation Forceps, 7x8 teeth

110mm, 4¹/₃"

400-025-110



GREEN

Fixation Forceps, 12mm wide jaw,
fine serrations

110mm, 4¹/₃"

400-029-012



RZ

Delicate Dressing forceps, straight,
100mm, 4"

straight 130-490-100

slightly curved 130-491-100

strongly curved 130-492-100





LUCAE

Dressing Aural Forceps, bayonet shape, serrated

140mm, 5^{1/2}" 410-391-140



JANSEN

Dressing Nasal Forceps, bayonet shape,
190mm, 7^{1/2}"

serrated 410-395-190

1x 2 teeth 410-396-190

210mm, 8^{1/4}"

serrated 410-395-210

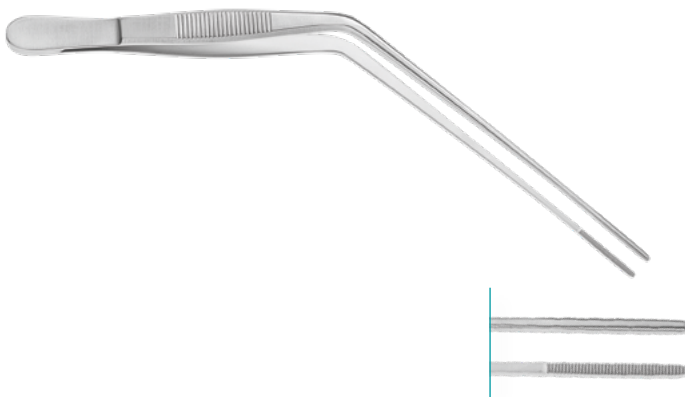

TROELTSCH (WILDE)

Dressing Nasal Forceps, knee bent

170mm, 6^{2/3}" 420-375-165

NON-STICK FORCEPS

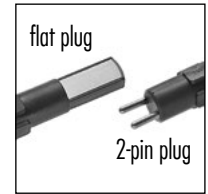

Straight		150mm		180mm		200mm	220mm
		straight tip	angled tip	straight tip	angled tip	straight tip	straight tip
0.3mm tip (point)	flat plug	700-610-150	700-611-150	700-610-180	700-611-180	700-610-200	700-610-220
	2-pin	700-612-150	700-613-150	700-612-180	700-613-180	700-612-200	700-620-220
0.6mm tip (blunt)	flat plug	700-620-150	700-621-150	700-620-180	700-621-180	700-620-200	700-620-220
	2-pin	700-622-150	700-623-150	700-622-180	700-623-180	700-622-200	700-622-220
1.0mm tip (blunt)	flat plug	700-630-150	700-631-150	700-630-180	700-631-180	700-630-200	700-630-220
	2-pin	700-632-150	700-633-150	700-632-180	700-633-180	700-632-200	700-632-220
2.0mm tip (blunt)	flat plug	700-640-150	700-641-150	700-640-180	700-641-180	700-640-200	700-640-220
	2-pin	700-642-150	700-643-150	700-642-180	700-643-180	700-642-200	700-642-220



		110mm	
JEWELER TYPE		straight tip	angled tip
0.25mm tip (point)	flat plug	700-601-710	700-601-730
	2-pin	700-601-711	700-601-731
0.6mm tip (blunt)	flat plug	700-601-712	700-601-732
	2-pin	700-601-713	700-601-733
1.0mm tip (blunt)	flat plug	700-601-714	700-601-734
	2-pin	700-601-715	700-601-735



straight tip

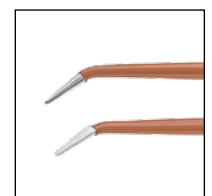

angled tip

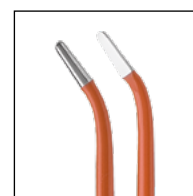

angled down tip

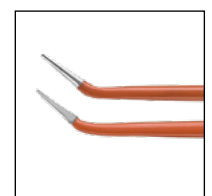

angled up tip

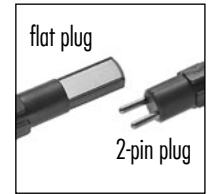

Bayonet Shape		180mm straight tip	200mm straight tip	220mm straight tip	240mm straight tip
0.3mm tip (point)	flat plug	700-650-180	700-650-200	700-650-220	700-650-240
	2-pin	700-652-180	700-652-200	700-652-220	700-652-240
0.6mm tip (blunt)	flat plug	700-660-180	700-660-200	700-660-220	700-660-240
	2-pin	700-662-180	700-662-200	700-662-220	700-662-240
1.0mm tip (blunt)	flat plug	700-670-180	700-670-200	700-670-220	700-670-240
	2-pin	700-672-180	700-672-200	700-672-220	700-672-240
2.0mm tip (blunt)	flat plug	700-680-180	700-680-200	700-680-220	700-680-240
	2-pin	700-682-180	700-682-200	700-682-220	700-682-240

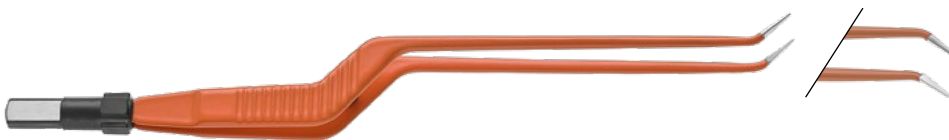

Bayonet Shape, angled up/angled down		200mm angled up tip	220mm angled up tip	200mm angled down tip	220mm angled down tip
1.0mm tip (blunt)	flat plug	700-670-201	700-670-221	700-670-203	700-670-223
	2-pin	700-672-201	700-672-221	700-672-203	700-672-223

NON-STICK FORCEPS, ROUND HANDLE

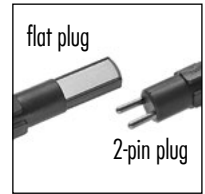

		150mm		180mm	
Straight		straight tip	angled tip	straight tip	angled tip
0.3mm tip (point)	flat plug	700-010-150	700-011-150	700-010-180	700-011-180
	2-pin	700-012-150	700-013-150	700-012-180	700-013-180
0.6mm tip (blunt)	flat plug	700-020-150	700-021-150	700-020-180	700-021-180
	2-pin	700-022-150	700-023-150	700-022-180	700-023-180
1.0mm tip (blunt)	flat plug	700-030-150	700-031-150	700-030-180	700-031-180
	2-pin	700-032-150	700-033-150	700-032-180	700-033-180
2.0mm tip (blunt)	flat plug	700-040-150	700-041-150	700-040-180	700-041-180
	2-pin	700-042-150	700-043-150	700-042-180	700-043-180
		200mm		225mm	
Straight		straight tip	angled tip	straight tip	angled tip
0.3mm tip (point)	flat plug	700-010-200	700-011-200	700-010-220	700-011-220
	2-pin	700-012-200	700-013-200	700-012-220	700-013-220
0.6mm tip (blunt)	flat plug	700-020-200	700-021-200	700-020-220	700-021-220
	2-pin	700-022-200	700-023-200	700-022-220	700-023-220
1.0mm tip (blunt)	flat plug	700-030-200	700-031-200	700-030-220	700-031-220
	2-pin	700-032-200	700-033-200	700-032-220	700-033-220
2.0mm tip (blunt)	flat plug	700-040-200	700-041-200	700-040-220	700-041-220
	2-pin	700-042-200	700-043-200	700-042-220	700-043-220

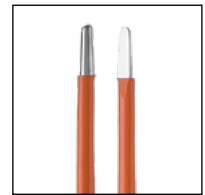

straight tip

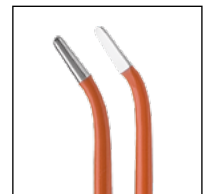

angled down tip

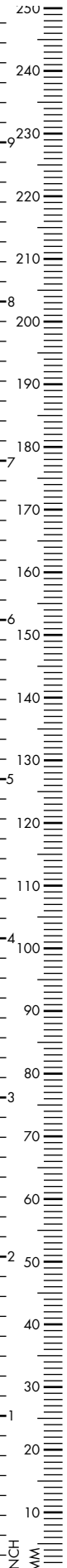

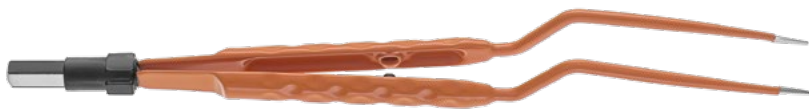
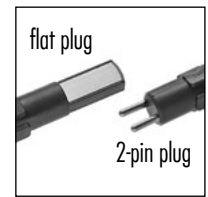

		180mm	200mm
Bayonet		straight tip	straight tip
0.3mm tip (point)	flat plug	700-050-180	700-050-200
	2-pin	700-052-180	700-052-200
0.6mm tip (blunt)	flat plug	700-060-180	700-060-200
	2-pin	700-062-180	700-062-200
1.0mm tip (blunt)	flat plug	700-070-180	700-072-200
	2-pin	700-072-180	700-072-200
2.0mm tip (blunt)	flat plug	700-080-180	700-082-200
	2-pin	700-082-180	700-082-200
		225mm	250mm
Bayonet		straight tip	straight tip
0.3mm tip (point)	flat plug	700-050-220	700-050-250
	2-pin	700-052-220	700-052-250
0.6mm tip (blunt)	flat plug	700-060-220	700-060-250
	2-pin	700-062-220	700-062-250
1.0mm tip (blunt)	flat plug	700-070-220	700-070-250
	2-pin	700-072-220	700-072-250
2.0mm tip (blunt)	flat plug	700-080-220	700-080-250
	2-pin	700-082-220	700-082-250



straight tip

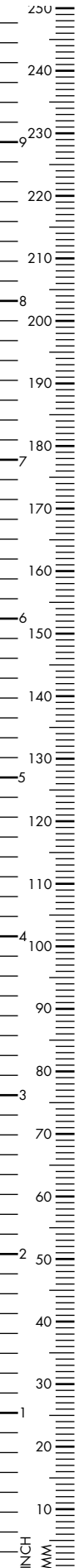

GILLIES

Monopolar Tissue Forceps, 1x2 teeth,
150mm, 6"

Without plug	130-720-150
4mm male plug	130-719-150



GERALD

Monopolar Tissue Forceps, 1x2 teeth,
180mm, 7"

Without plug	130-750-180
4mm male plug	130-749-180
230mm, 9"	
Without plug	130-750-230
4mm male plug	130-749-230

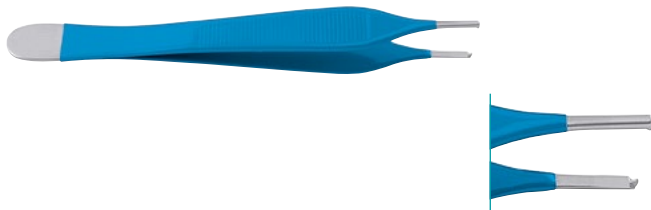

ADSON

Monopolar Tissue Forceps, 1x2 teeth, 2mm tip,
120mm, 4^{3/4}"

Without plug	130-740-120
4mm male plug	130-746-120

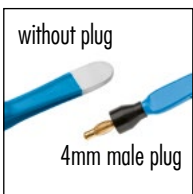



MICRO ADSON

Monopolar Tissue Forceps, 1x2 teeth, 2mm tip, 150mm, 6"

Without plug 130-750-150

4mm male plug 130-751-150

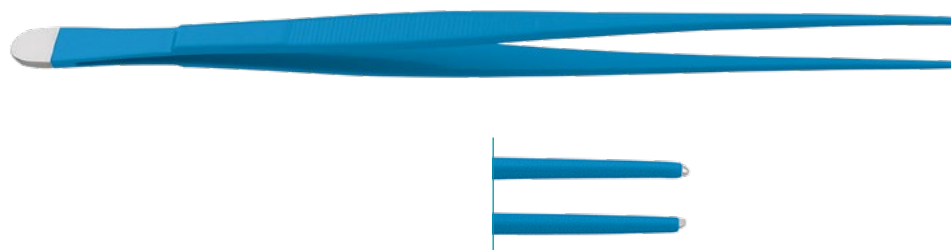

SULLIVAN

Monopolar Forceps, very delicate, smooth jaw, 1mm tip, 250mm, 9⁷/₈"

Without plug 130-743-250

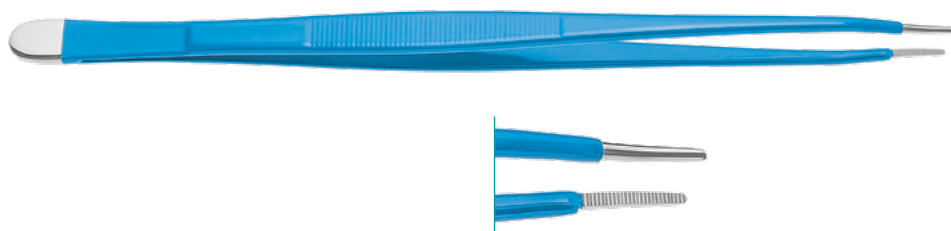

POTTS SMITH

Monopolar Dressing Forceps, serrated, elevated shanks, without plug

180mm, 7" 130-738-180

210mm, 8¹/₄" 130-738-210

250mm, 9⁷/₈" 130-738-250

300mm, 11⁷/₈" 130-738-300

180mm, 7" 130-752-180

210mm, 8¹/₄" 130-752-210

250mm, 9⁷/₈" 130-752-250

300mm, 11⁷/₈" 130-752-300

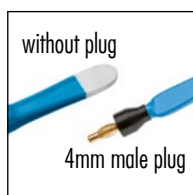

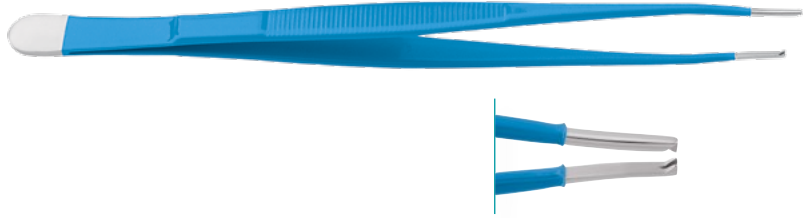
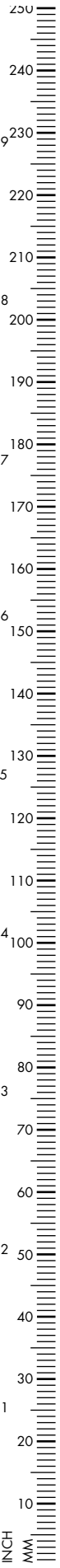

POTTS SMITH

Monopolar Tissue Forceps, 1x2 teeth, elevated shanks, without plug

180mm, 7"	130-741-180
210mm, 8 ¹ / ₄ "	130-741-210
250mm, 9 ⁷ / ₈ "	130-741-250
300mm, 11 ⁷ / ₈ "	130-741-300

4mm male plug

180mm, 7"	130-748-180
210mm, 8 ¹ / ₄ "	130-748-210
250mm, 9 ⁷ / ₈ "	130-748-250
300mm, 11 ⁷ / ₈ "	130-748-300

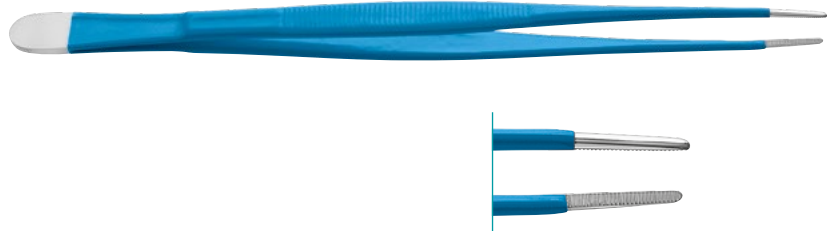

POTTS SMITH

Monopolar Dressing Forceps, serrated, without plug

145mm, 5 ³ / ₄ "	130-740-145
180mm, 7"	130-740-180
210mm, 8 ¹ / ₄ "	130-740-210
250mm, 9 ⁷ / ₈ "	130-740-250
300mm, 11 ⁷ / ₈ "	130-740-300

4mm male plug

145mm, 5 ³ / ₄ "	130-747-145
180mm, 7"	130-747-180
210mm, 8 ¹ / ₄ "	130-747-210
250mm, 9 ⁷ / ₈ "	130-747-250
300mm, 11 ⁷ / ₈ "	130-747-300



POTTS SMITH

Monopolar Tissue Forceps, 1x2 teeth, without plug

145mm, 5 ³ / ₄ "	130-753-145
180mm, 7"	130-753-180
210mm, 8 ¹ / ₄ "	130-753-210
250mm, 9 ⁷ / ₈ "	130-753-250
300mm, 11 ⁷ / ₈ "	130-753-300

4mm male plug

145mm, 5 ³ / ₄ "	130-754-145
180mm, 7"	130-754-180
210mm, 8 ¹ / ₄ "	130-754-210
250mm, 9 ⁷ / ₈ "	130-754-250
300mm, 11 ⁷ / ₈ "	130-754-300

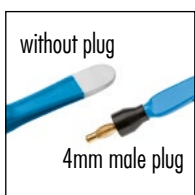

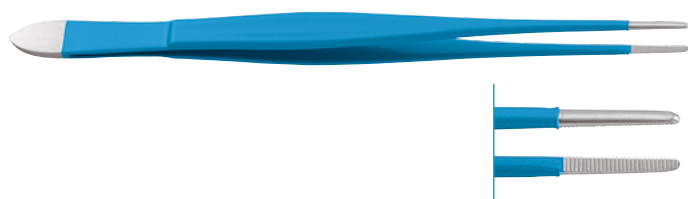

CUSHING

Monopolar Dressing Forceps, serrated, without plug

175mm, 6 ⁷ / ₈ "	130-736-175
200mm, 8"	130-736-200

4mm male plug

175mm, 6 ⁷ / ₈ "	130-737-175
200mm, 8"	130-737-200

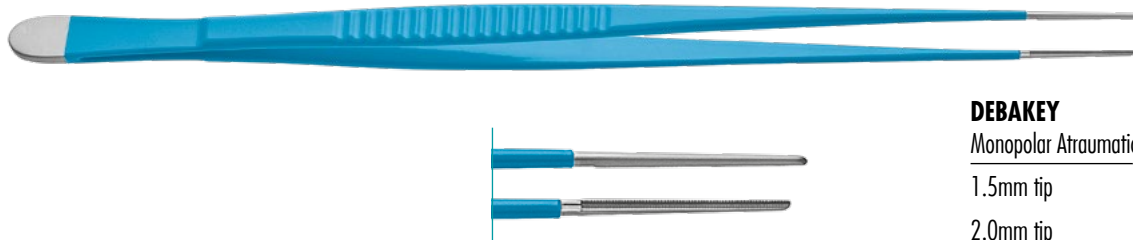

DEBAKEY

Monopolar Atraumatic Forceps, 160mm, 6¹/₄"

1.5mm tip	290-850-160
2.0mm tip	290-851-160
2.4mm tip	290-852-160
2.7mm tip	290-853-160
3.5mm tip	290-854-160

200mm, 8"

1.5mm tip	290-850-200
2.0mm tip	290-851-200
2.4mm tip	290-852-200
2.7mm tip	290-853-200
3.5mm tip	290-854-200

240mm, 9¹/₂"

1.5mm tip	290-850-240
2.0mm tip	290-851-240
2.4mm tip	290-852-240
2.7mm tip	290-853-240
3.5mm tip	290-854-240

300mm, 11⁷/₈"

1.5mm tip	290-850-300
2.0mm tip	290-851-300
2.4mm tip	290-852-300
2.7mm tip	290-853-300
3.5mm tip	290-854-300

