

# CLAMPS AND FORCEPS

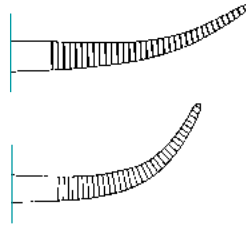

Hemostatic Forceps  
Dissecting Forceps  
Tissue Forceps  
Intestinal Forceps  
Towel Forceps  
Tubing Clamps  
Dressing and Sponge Forceps



### JACOBSON

Hemostatic Forceps, delicate, 0.3mm tip, curved

100mm, 4"	140-161-100
130mm, 5 <sup>1</sup> / <sub>8</sub> "	140-161-130
190mm, 7 <sup>1</sup> / <sub>2</sub> "	140-161-190

fully curved

130mm, 5 <sup>1</sup> / <sub>8</sub> "	140-162-130
190mm, 7 <sup>1</sup> / <sub>2</sub> "	140-162-190

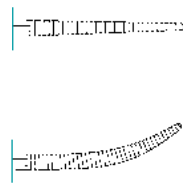
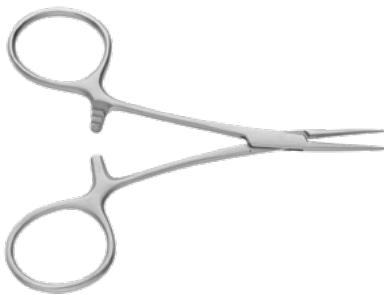

### MICRO HALSTEAD MOSQUITO

Hemostatic Forceps, straight

100mm, 4"	140-270-100
120mm, 4 <sup>3</sup> / <sub>4</sub> "	140-270-120

curved

100mm, 4"	140-271-100
120mm, 4 <sup>3</sup> / <sub>4</sub> "	140-271-120

straight, 1x2 teeth

100mm, 4"	140-272-100
120mm, 4 <sup>3</sup> / <sub>4</sub> "	140-272-120

curved, 1x2teeth

100mm, 4"	140-273-100
120mm, 4 <sup>3</sup> / <sub>4</sub> "	140-273-120

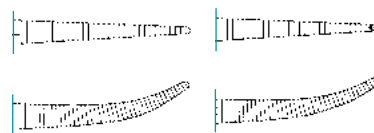
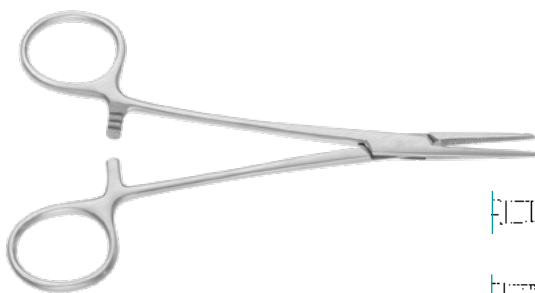

### HALSTEAD MOSQUITO

Hemostatic Forceps, serrated, straight

125mm, 5"	140-254-125
140mm, 5 <sup>1</sup> / <sub>2</sub> "	140-254-140
180mm, 7"	140-254-180
210mm, 8 <sup>1</sup> / <sub>4</sub> "	140-254-210

serrated, curved

125mm, 5"	140-255-125
140mm, 5 <sup>1</sup> / <sub>2</sub> "	140-255-140
180mm, 7"	140-255-180
210mm, 8 <sup>1</sup> / <sub>4</sub> "	140-255-210

1x2 teeth, straight

125mm, 5"	140-256-125
140mm, 5 <sup>1</sup> / <sub>2</sub> "	140-256-140
180mm, 7"	140-256-180
210mm, 8 <sup>1</sup> / <sub>4</sub> "	140-256-210

1x2 teeth, curved

125mm, 5"	140-257-125
140mm, 5 <sup>1</sup> / <sub>2</sub> "	140-257-140
180mm, 7"	140-257-180
210mm, 8 <sup>1</sup> / <sub>4</sub> "	140-257-210

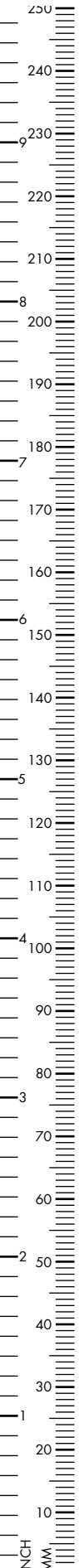

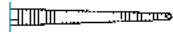
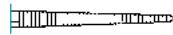

### HARTMANN MOSQUITO

Hemostatic Forceps, serrated, straight

100mm, 4" 140-250-100

1x2 teeth, straight

100mm, 4" 140-248-100

serrated, curved

100mm, 4" 140-251-100

1x2 teeth, curved

100mm, 4" 140-249-100

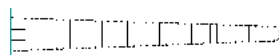

### CRILE

Hemostatic Forceps, serrated, straight

140mm, 5 1/2" 140-290-140

1x2 teeth, straight

140mm, 5 1/2" 140-292-140

serrated, curved

140mm, 5 1/2" 140-291-140

1x2 teeth, curved

140mm, 5 1/2" 140-293-140



### BABY CRILE

Hemostatic Forceps, 140mm, 5 1/2"

serrated, straight 140-334-140

serrated, curved 140-335-140

1x2 teeth, straight 140-336-140

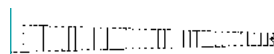
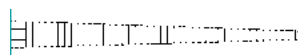

### CRILE RANKIN

Hemostatic Forceps, serrated, straight

160mm, 6 1/4" 140-294-160

1x2 teeth, straight

160mm, 6 1/4" 140-296-160

serrated, curved

160mm, 6 1/4" 140-295-160

1x2 teeth, curved

160mm, 6 1/4" 140-297-160

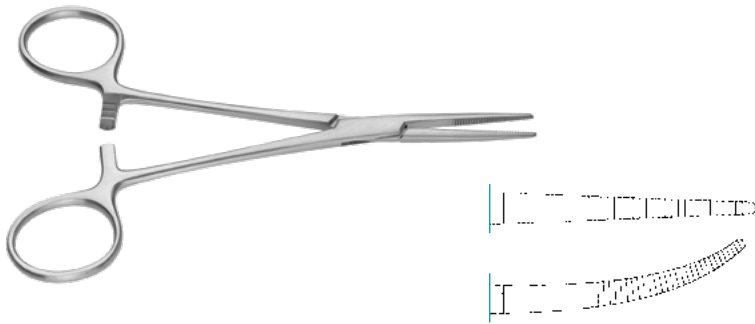
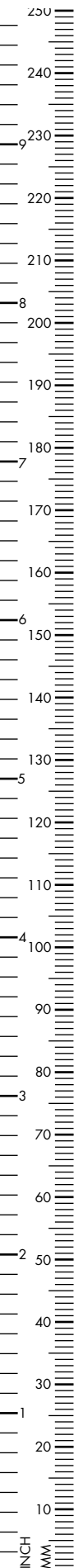

### KELLY

Hemostatic Forceps, straight

140mm, 5 <sup>1</sup> / <sub>2</sub> "	140-280-140
--	-------------

curved

140mm, 5 <sup>1</sup> / <sub>2</sub> "	140-281-140
--	-------------

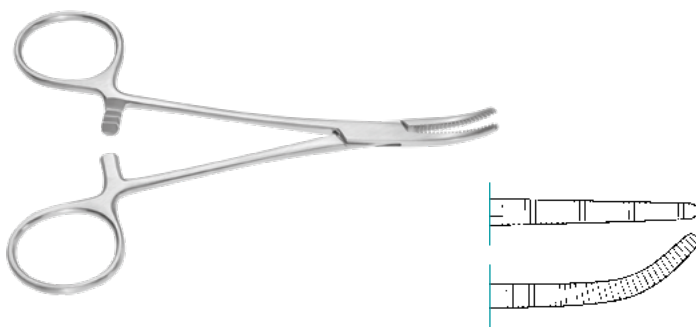

### SPENCER WELLS

Hemostatic Forceps, serrated, straight

130mm, 5 <sup>1</sup> / <sub>8</sub> "	140-150-130
--	-------------

150mm, 6"	140-150-150
-----------	-------------

180mm, 7"	140-150-180
-----------	-------------

200mm, 8"	140-150-200
-----------	-------------

curved

130mm, 5 <sup>1</sup> / <sub>8</sub> "	140-151-130
--	-------------

150mm, 6"	140-151-150
-----------	-------------

180mm, 7"	140-151-180
-----------	-------------

200mm, 8"	140-151-200
-----------	-------------

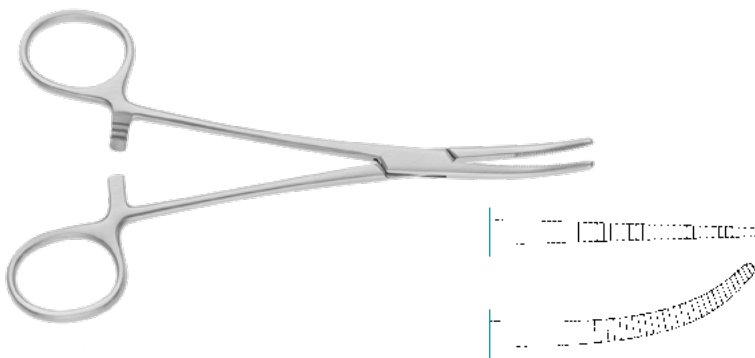

### KELLY RANKIN

Hemostatic Forceps, straight

160mm, 6 <sup>1</sup> / <sub>4</sub> "	140-286-160
--	-------------

curved

160mm, 6 <sup>1</sup> / <sub>4</sub> "	140-287-160
--	-------------

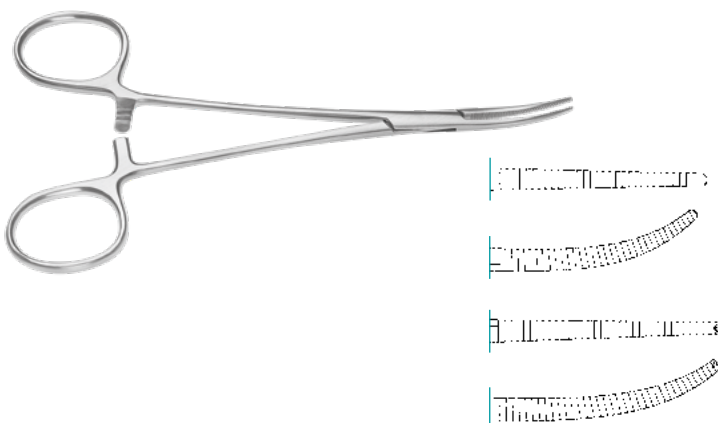

### LERICHE

Hemostatic Forceps, 150mm, 6"

straight	140-276-150
----------	-------------

curved	140-277-150
--------	-------------

straight, 1x2 teeth	140-278-150
---------------------	-------------

curved, 1x2 teeth	140-279-150
-------------------	-------------

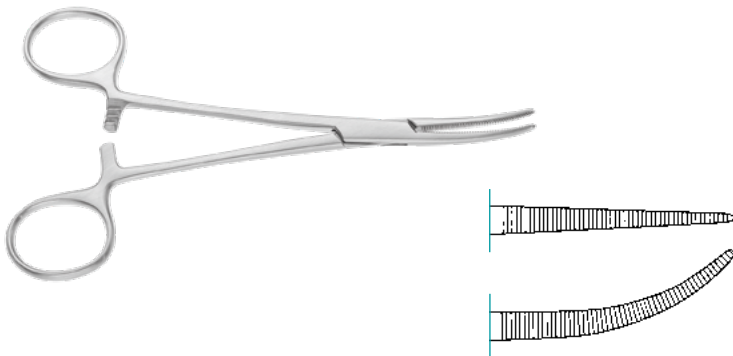

### COLLER

Hemostatic Forceps, serrated, straight

140mm, 5<sup>1</sup>/<sub>2</sub>" 140-288-140

160mm, 6<sup>1</sup>/<sub>4</sub>" 140-288-160

curved

140mm, 5<sup>1</sup>/<sub>2</sub>" 140-289-140

160mm, 6<sup>1</sup>/<sub>4</sub>" 140-289-160

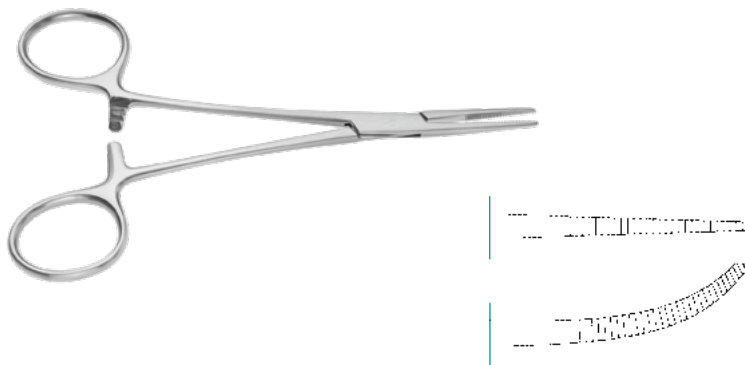

### PROVIDENCE HOSPITAL

Hemostatic Forceps, serrated, straight

140mm, 5<sup>1</sup>/<sub>2</sub>" 140-274-140

curved

140mm, 5<sup>1</sup>/<sub>2</sub>" 140-275-140

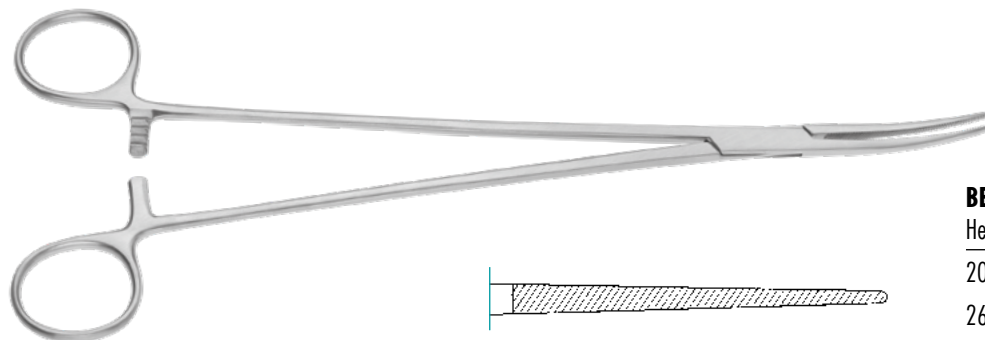

### BENGOLEA

Hemostatic Forceps, serrated, straight

200mm, 8" 140-140-200

260mm, 10<sup>1</sup>/<sub>4</sub>" 140-140-260

serrated, curved

200mm, 8" 140-141-200

260mm, 10<sup>1</sup>/<sub>4</sub>" 140-141-260

1x2 teeth, straight

200mm, 8" 140-142-200

260mm, 10<sup>1</sup>/<sub>4</sub>" 140-142-260

1x2 teeth, curved

200mm, 8" 140-143-200

260mm, 10<sup>1</sup>/<sub>4</sub>" 140-143-260

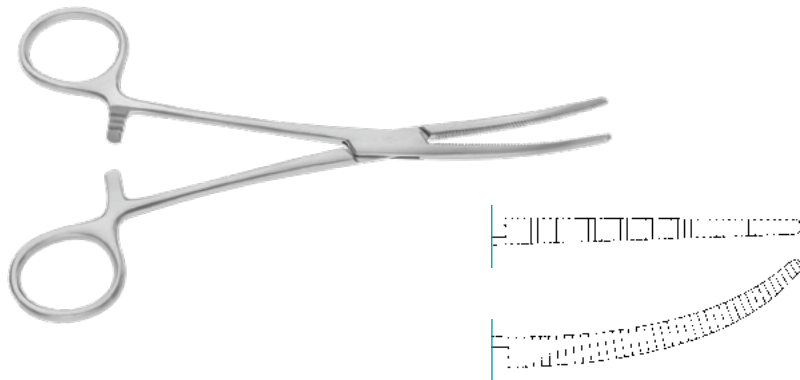

### ROCHESTER PEAN

Hemostatic Forceps, serrated, straight

140mm, 5 <sup>1</sup> / <sub>2</sub> "	140-330-140
160mm, 6 <sup>1</sup> / <sub>4</sub> "	140-330-160
180mm, 7"	140-330-180
200mm, 8"	140-330-200
220mm, 8 <sup>2</sup> / <sub>3</sub> "	140-330-220
240mm, 9 <sup>1</sup> / <sub>2</sub> "	140-330-240
260mm, 10 <sup>1</sup> / <sub>4</sub> "	140-330-260
300mm, 11 <sup>7</sup> / <sub>8</sub> "	140-330-300
355mm, 14"	140-330-355

curved

140mm, 5 <sup>1</sup> / <sub>2</sub> "	140-331-140
160mm, 6 <sup>1</sup> / <sub>4</sub> "	140-331-160
180mm, 7"	140-331-180
200mm, 8"	140-331-200
220mm, 8 <sup>2</sup> / <sub>3</sub> "	140-331-220
240mm, 9 <sup>1</sup> / <sub>2</sub> "	140-331-240
260mm, 10 <sup>1</sup> / <sub>4</sub> "	140-331-260
300mm, 11 <sup>7</sup> / <sub>8</sub> "	140-331-300
355mm, 14"	140-331-355

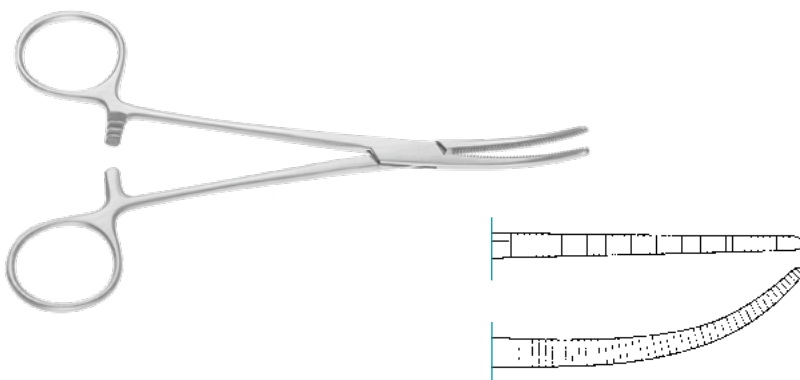

### PEAN

Hemostatic Forceps, delicate, serrated, straight

130mm, 5 <sup>1</sup> / <sub>8</sub> "	140-316-130
140mm, 5 <sup>1</sup> / <sub>2</sub> "	140-316-140
160mm, 6 <sup>1</sup> / <sub>4</sub> "	140-316-160

curved

130mm, 5 <sup>1</sup> / <sub>8</sub> "	140-317-130
140mm, 5 <sup>1</sup> / <sub>2</sub> "	140-317-140
160mm, 6 <sup>1</sup> / <sub>4</sub> "	140-317-160

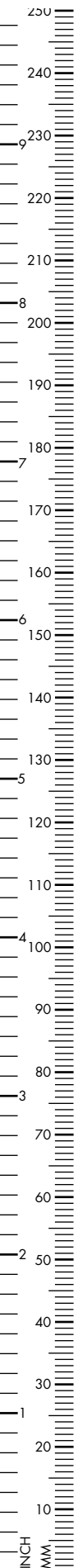

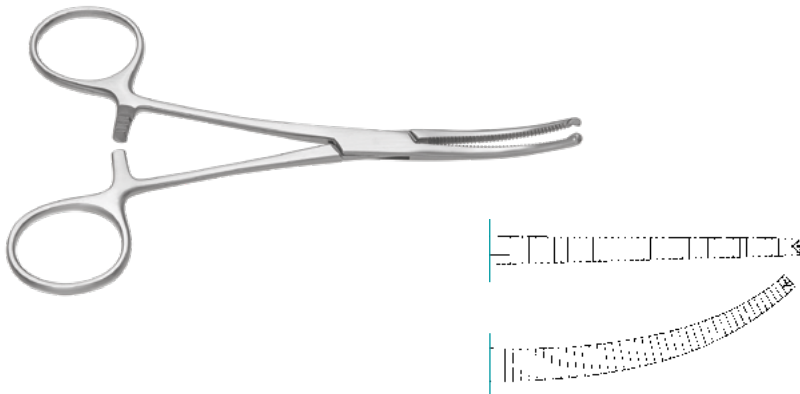

### KOCHER OCHSNER

Hemostatic Forceps, 1x 2 teeth, straight

140mm, 5 <sup>1</sup> / <sub>2</sub> "	140-332-140
160mm, 6 <sup>1</sup> / <sub>4</sub> "	140-332-160
180mm, 7"	140-332-180
200mm, 8"	140-332-200
220mm, 8 <sup>2</sup> / <sub>3</sub> "	140-332-220
240mm, 9 <sup>1</sup> / <sub>2</sub> "	140-332-240
260mm, 10 <sup>1</sup> / <sub>4</sub> "	140-332-260
300mm, 11 <sup>7</sup> / <sub>8</sub> "	140-332-300
355mm, 14"	140-332-355

curved

140mm, 5 <sup>1</sup> / <sub>2</sub> "	140-333-140
160mm, 6 <sup>1</sup> / <sub>4</sub> "	140-333-160
180mm, 7"	140-333-180
200mm, 8"	140-333-200
220mm, 8 <sup>2</sup> / <sub>3</sub> "	140-333-220
240mm, 9 <sup>1</sup> / <sub>2</sub> "	140-333-240
260mm, 10 <sup>1</sup> / <sub>4</sub> "	140-333-260
300mm, 11 <sup>7</sup> / <sub>8</sub> "	140-333-300
355mm, 14"	140-333-355

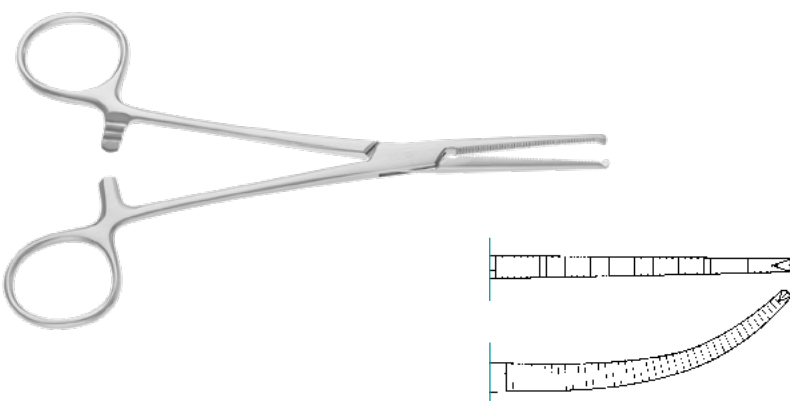

### KOCHER

Delicate Hemostatic Forceps, 1x2 teeth, straight

130mm, 5 <sup>1</sup> / <sub>8</sub> "	140-318-130
140mm, 5 <sup>1</sup> / <sub>2</sub> "	140-318-140
160mm, 6 <sup>1</sup> / <sub>4</sub> "	140-318-160

curved

130mm, 5 <sup>1</sup> / <sub>8</sub> "	140-319-130
140mm, 5 <sup>1</sup> / <sub>2</sub> "	140-319-140
160mm, 6 <sup>1</sup> / <sub>4</sub> "	140-319-160

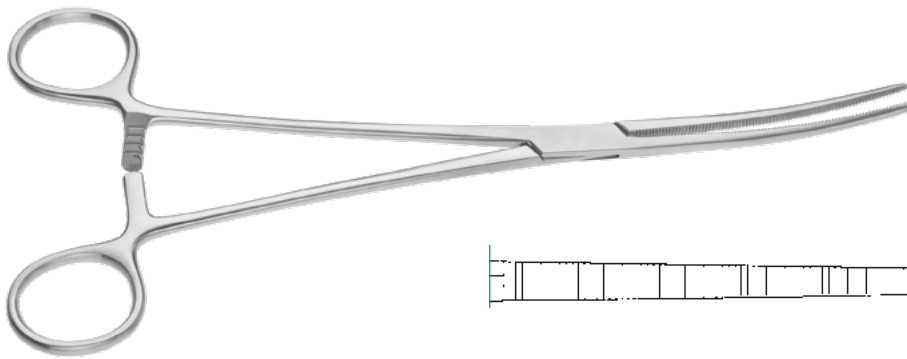

### SAROT

Hemostatic Forceps, 240mm, 9<sup>1</sup>/<sub>2</sub>"

straight	140-348-240
curved	140-349-240

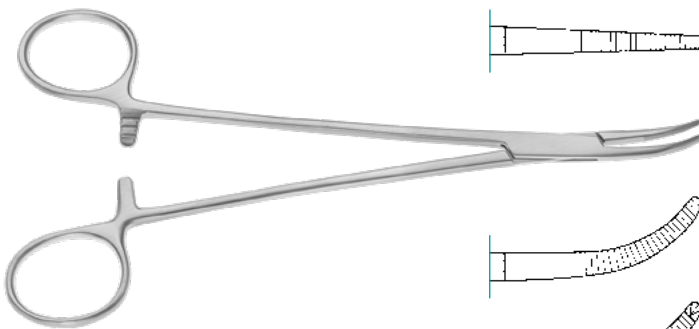
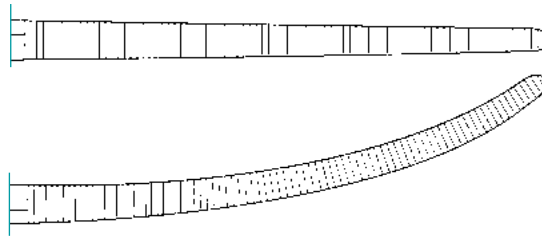

### ADSON

Hemostatic Forceps, 185mm, 7<sup>1</sup>/<sub>4</sub>"

serrated, straight	140-366-185
serrated, curved	140-367-185
straight, 1x2 teeth	140-372-185
curved, 1x2 teeth	140-373-185

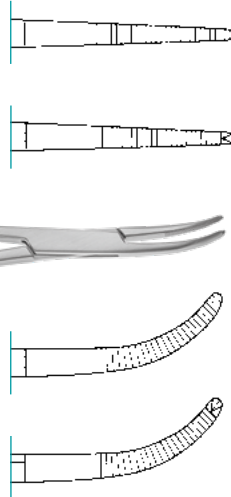

### BIRKETT

Hemostatic Forceps, serrated, 185mm, 7<sup>1</sup>/<sub>4</sub>"

straight	140-368-185
curved	140-369-185

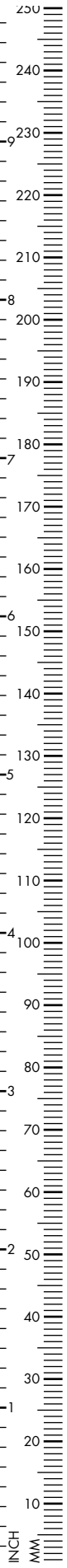
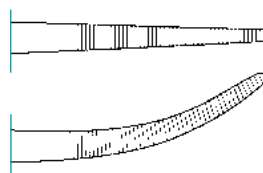



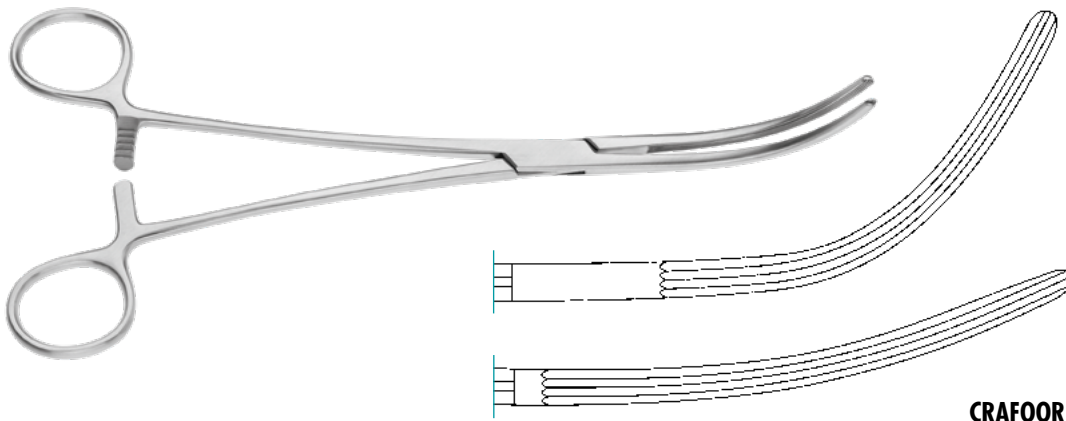

### CRAFOORD

Vascular Clamp, longitudinal serration, slightly curved, elastic jaw

230mm, 9"	140-383-230
-----------	-------------

medium curved

240mm, 9 <sup>1/2</sup> "	140-385-240
---------------------------	-------------

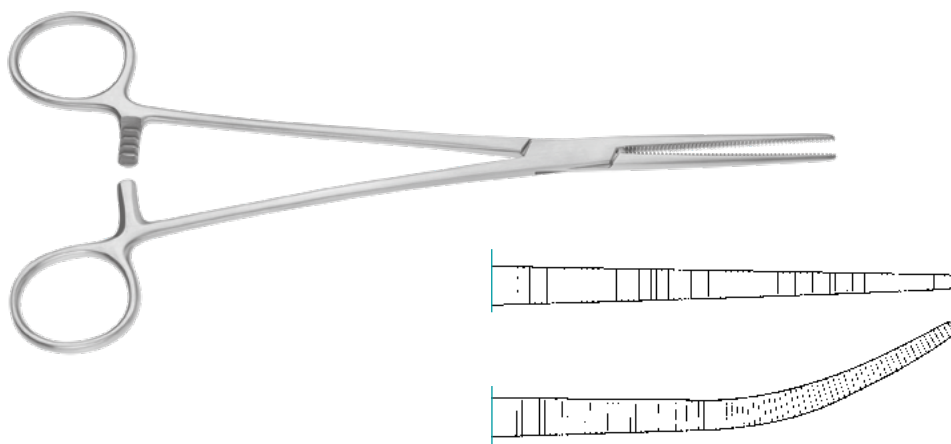

### ROBERTS

Hemostatic Forceps, 220mm, 8<sup>2/3</sup>"

straight	140-452-220
----------	-------------

curved	140-453-220
--------	-------------

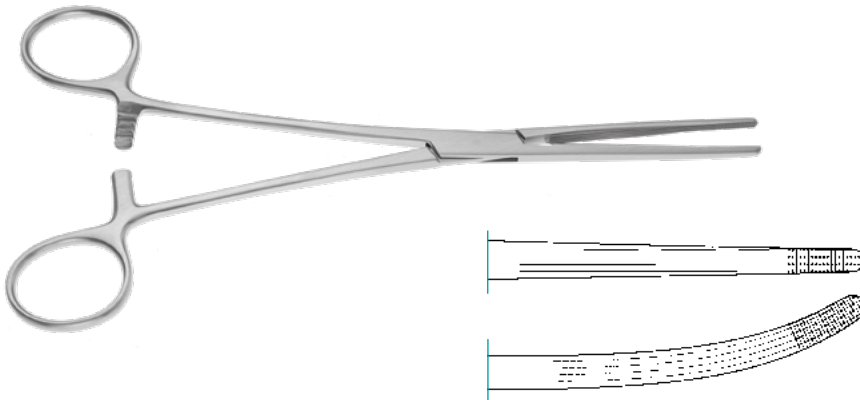
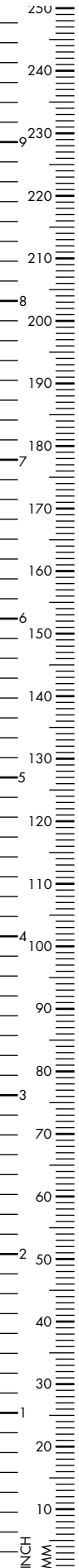

### ROCHESTER CARMALT

Hemostatic Forceps, longitudinal serration, cross-serrated tip, straight

160mm, 6<sup>1/4</sup>" 140-314-160

200mm, 8" 140-314-200

curved

160mm, 6<sup>1/4</sup>" 140-315-160

200mm, 8" 140-315-200

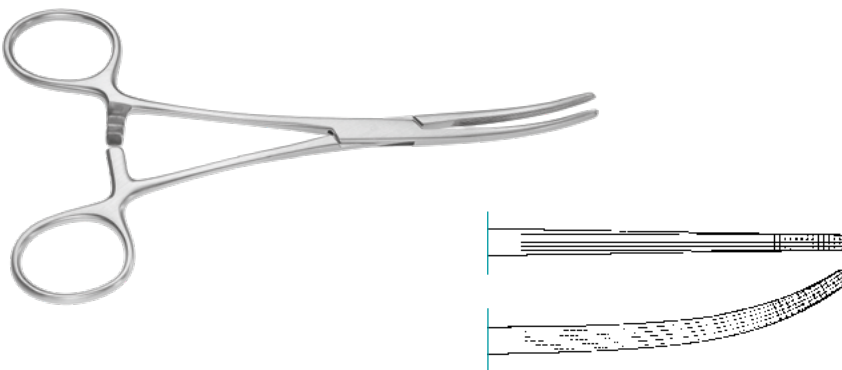

### BAINBRIDGE

Intestinal Forceps, longitudinal serration, cross-serrated tip, straight

150mm, 6" 140-442-150

185mm, 7<sup>1/4</sup>" 140-442-185

curved

150mm, 6" 140-443-150

185mm, 7<sup>1/4</sup>" 140-443-185

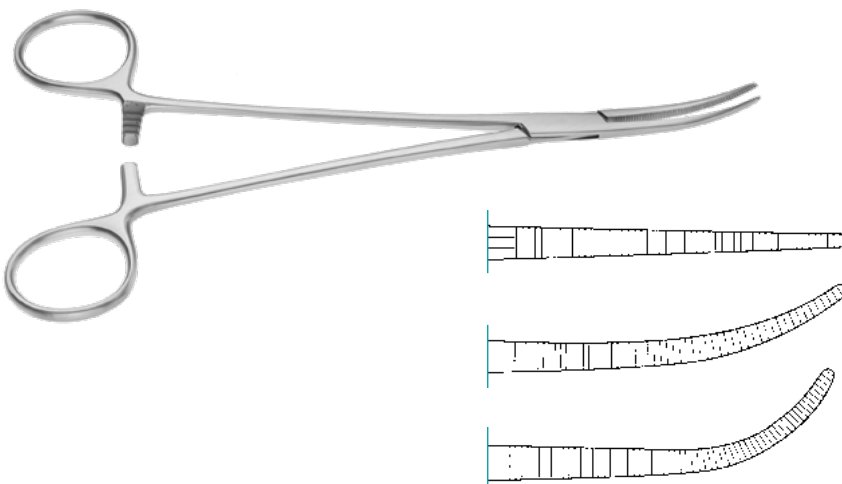

### HEISS

Dissecting and Ligature Forceps, straight, Fig. 1

200mm, 8" 140-340-200

slightly curved, Fig. 2

200mm, 8" 140-341-200

strongly curved, Fig. 3

200mm, 8" 140-343-200

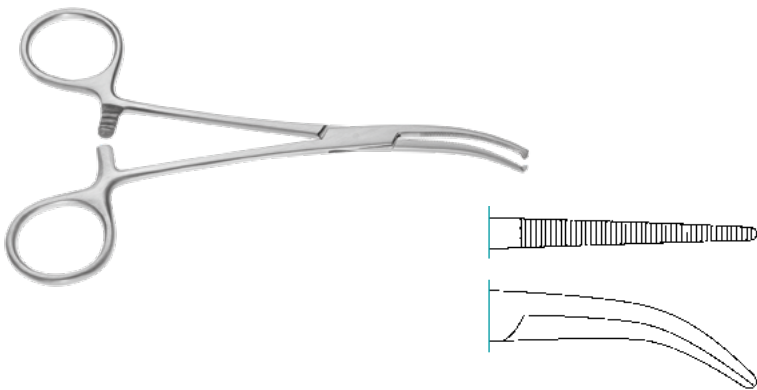

### DANDY

Hemostatic Forceps, laterally curved,  
140mm, 5<sup>1</sup>/<sub>2</sub>"

serrated	140-301-140
1x2 teeth	140-303-140

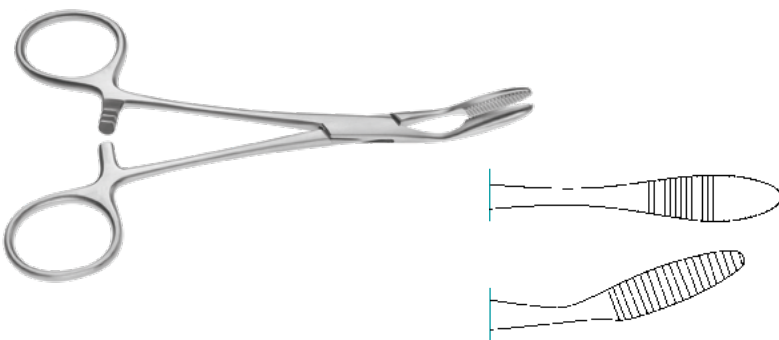

### PEAN

Hemostatic Forceps, serrated, straight

125mm, 4 <sup>3</sup> / <sub>4</sub> "	140-228-125
140mm, 5 <sup>1</sup> / <sub>2</sub> "	140-228-140
160mm, 6 <sup>1</sup> / <sub>4</sub> "	140-228-160
curved	
140mm, 5 <sup>1</sup> / <sub>2</sub> "	140-229-140

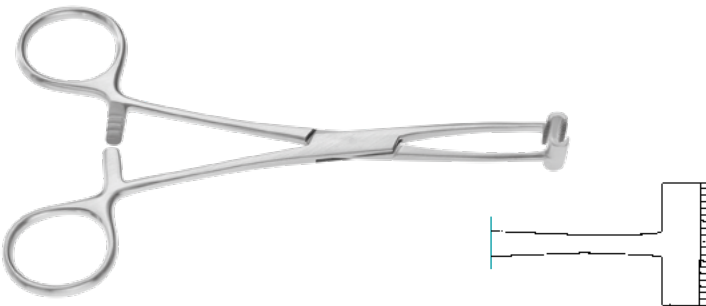

### PRATT

T-Clamp, straight

150mm, 6"	140-282-150
-----------	-------------

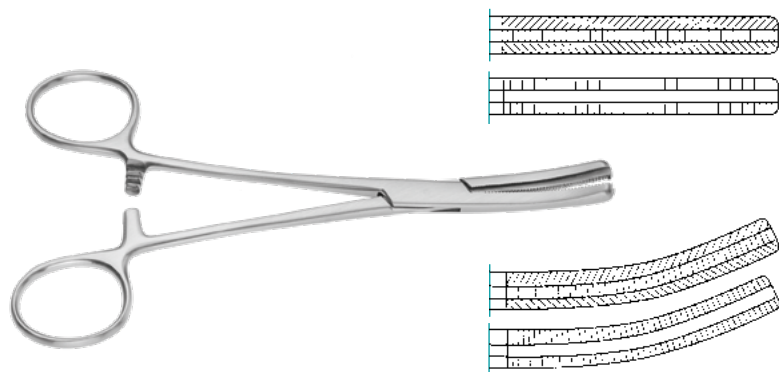

### FERGUSON

Pressure Clamp, straight

160mm, 6 <sup>1</sup> / <sub>4</sub> "	140-300-160
curved	
160mm, 6 <sup>1</sup> / <sub>4</sub> "	140-301-160

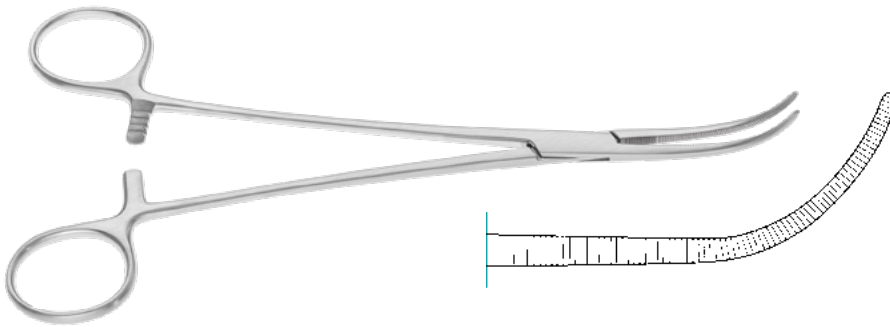

### OVERHOLT MIXER

Dissecting and Ligature Forceps, curved

210mm, 8<sup>1</sup>/<sub>4</sub>" 140-345-210

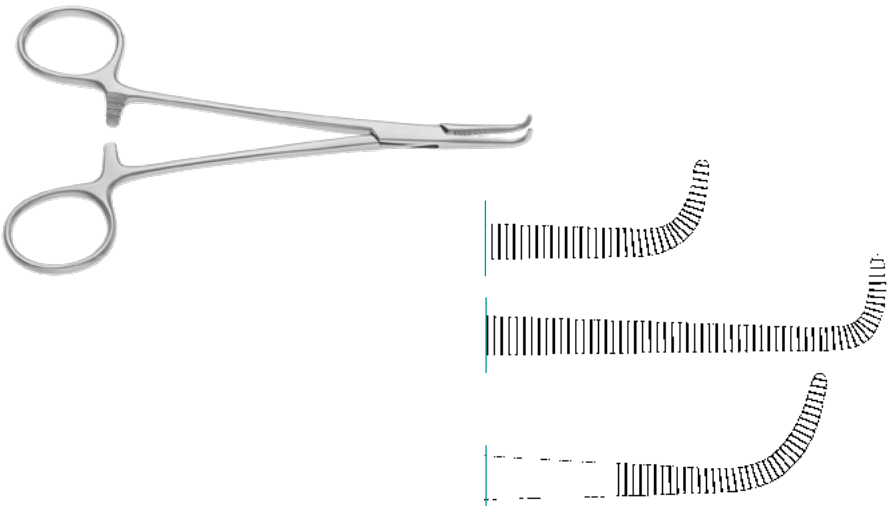

### DIETRICH

Clamp, serrated, right angled

125mm, 5" 140-401-125

140mm, 5<sup>1</sup>/<sub>2</sub>" 140-401-140

180mm, 7" 140-401-180

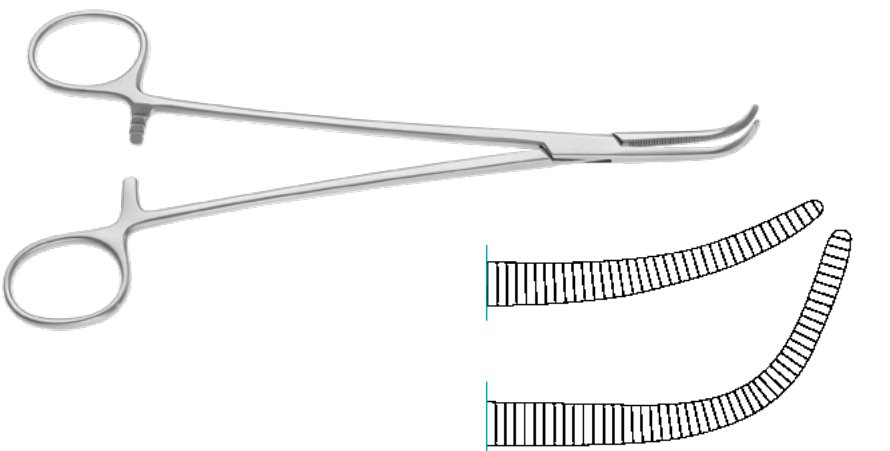

### VARCO

Gallbladder Forceps, slightly curved

190mm, 7<sup>1</sup>/<sub>2</sub>" 140-403-190

fully curved

200mm, 8" 140-403-200

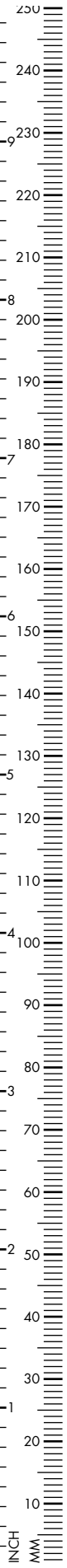

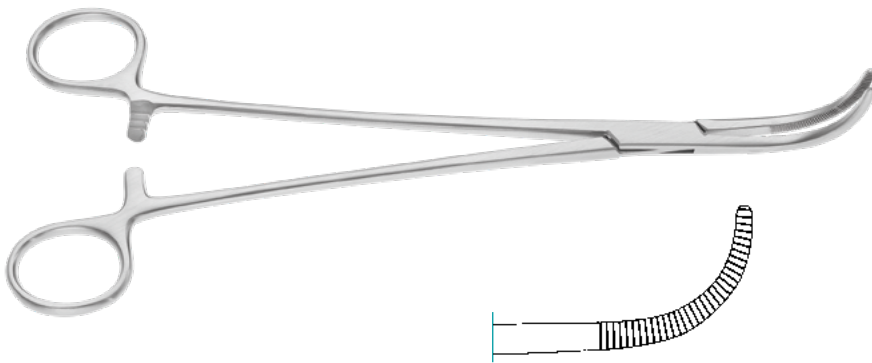

### MIXER

Dissecting and Ligature Forceps,  
partially serrated

220mm, 8 <sup>2</sup> / <sub>3</sub> "	140-427-220
230mm, 9"	140-429-230

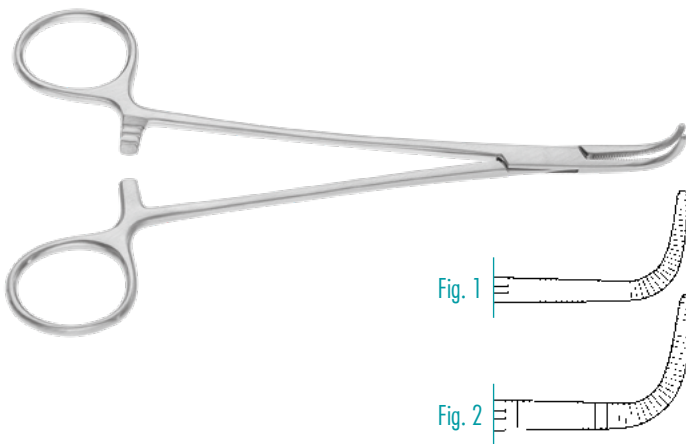

### MEEKER

Kidney Pedicle Clamp, curved,  
Fig. 1

180mm, 7"	140-619-180
-----------	-------------

Fig. 2

280mm, 11"	140-619-275
------------	-------------

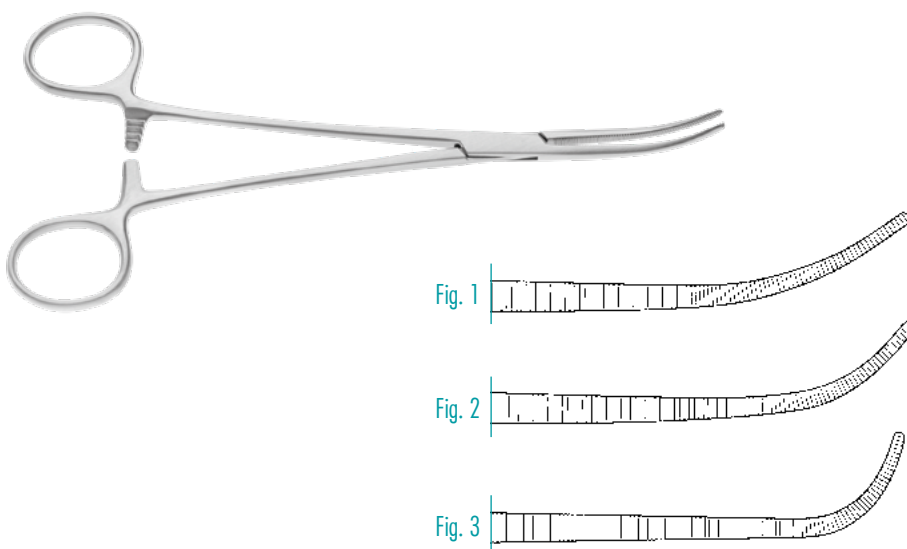

### KELLY

Dissecting Forceps, fully serrated,  
Fig. 1

190mm, 7 <sup>1</sup> / <sub>2</sub> "	140-633-190
220mm, 8 <sup>2</sup> / <sub>3</sub> "	140-633-220
240mm, 9 <sup>1</sup> / <sub>2</sub> "	140-633-240

Fig. 2

190mm, 7 <sup>1</sup> / <sub>2</sub> "	140-635-190
220mm, 8 <sup>2</sup> / <sub>3</sub> "	140-635-220
240mm, 9 <sup>1</sup> / <sub>2</sub> "	140-635-240

Fig. 3

190mm, 7 <sup>1</sup> / <sub>2</sub> "	140-637-190
220mm, 8 <sup>2</sup> / <sub>3</sub> "	140-637-220
240mm, 9 <sup>1</sup> / <sub>2</sub> "	140-637-240

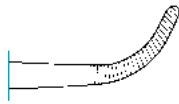

### BABY MIXTER

Dissecting and Ligature Forceps,  
serrated, curved

140mm, 5<sup>1</sup>/<sub>2</sub>"

140-421-140

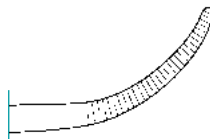
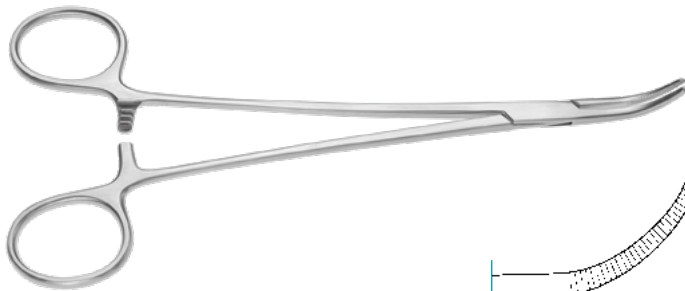

### BABY MIXTER

Dissecting and Ligature Forceps,  
serrated, curved

180mm, 7"

140-337-180

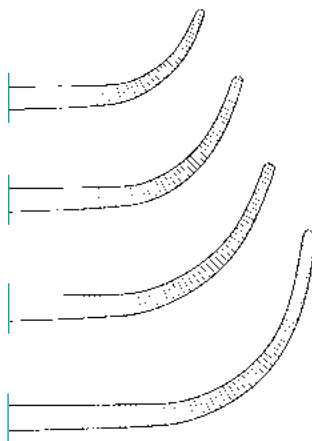
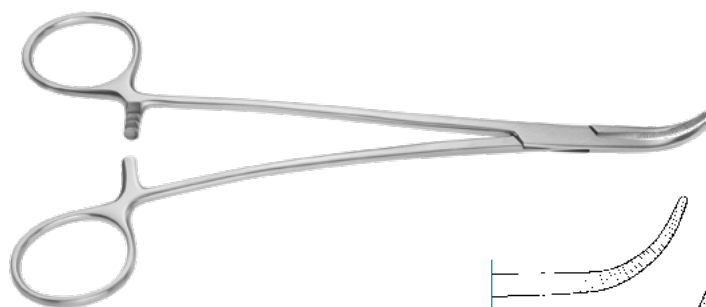

### OVERHOLT

Dissecting and Ligature Forceps,  
serrated, s-curved

185mm, 7<sup>1</sup>/<sub>2</sub>"

140-135-185

205mm, 8"

140-135-205

210mm, 8<sup>1</sup>/<sub>4</sub>"

140-135-210

215mm, 8<sup>1</sup>/<sub>2</sub>"

140-135-215

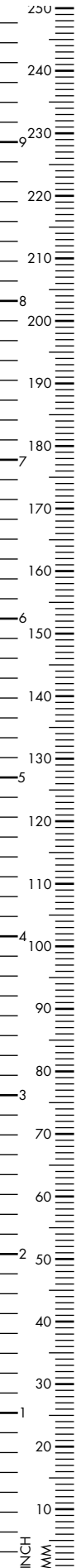

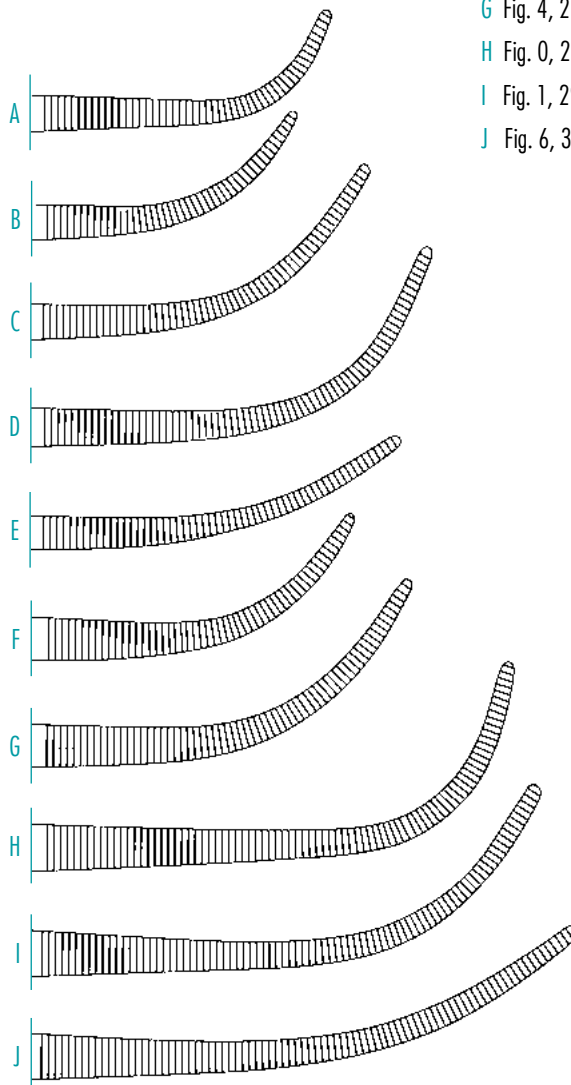

### OVERHOLT

Ligature Forceps, fully serrated jaw, curved

A	Fig. 0, 215mm, 8 <sup>1</sup> / <sub>2</sub> "	140-137-000
B	Fig. 1, 210mm, 8 <sup>1</sup> / <sub>4</sub> "	140-137-001
C	Fig. 2, 220mm, 8 <sup>2</sup> / <sub>3</sub> "	140-137-002
D	Fig. 3, 225mm, 8 <sup>7</sup> / <sub>8</sub> "	140-137-003
E	Fig. 6, 225mm, 8 <sup>7</sup> / <sub>8</sub> "	140-137-006
F	Fig. 1, 270mm, 10 <sup>2</sup> / <sub>3</sub> "	140-137-008
G	Fig. 4, 270mm, 10 <sup>2</sup> / <sub>3</sub> "	140-137-014
H	Fig. 0, 295mm, 11 <sup>2</sup> / <sub>3</sub> "	140-137-010
I	Fig. 1, 295mm, 11 <sup>2</sup> / <sub>3</sub> "	140-137-011
J	Fig. 6, 300mm, 11 <sup>7</sup> / <sub>8</sub> "	140-137-016

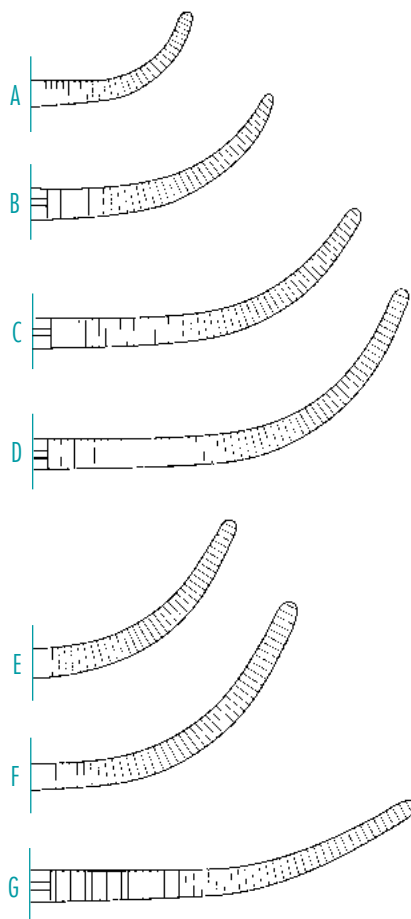

### OVERHOLT

Dissecting and Ligature Forceps,  
fully serrated, curved

A Fig. 0,	140-443-001
195mm, 7 <sup>3</sup> / <sub>4</sub> "	
B Fig. 1,	140-443-002
210mm, 8 <sup>1</sup> / <sub>4</sub> "	
C Fig. 2,	140-443-003
220mm, 8 <sup>2</sup> / <sub>3</sub> "	
D Fig. 3,	140-443-004
225mm, 8 <sup>7</sup> / <sub>8</sub> "	
E Fig. 4,	140-443-005
210mm, 8 <sup>1</sup> / <sub>4</sub> "	
F Fig. 5,	140-443-006
230mm, 9"	
G Fig. 6,	140-443-007
225mm, 8 <sup>7</sup> / <sub>8</sub> "	

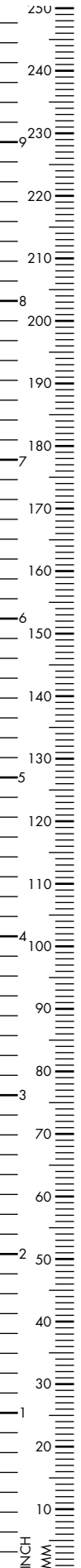





### **BABY OVERHOLT**

Hemostatic Forceps, fully serrated, curved

130mm, 5<sup>1</sup>/<sub>8</sub>" 140-285-135

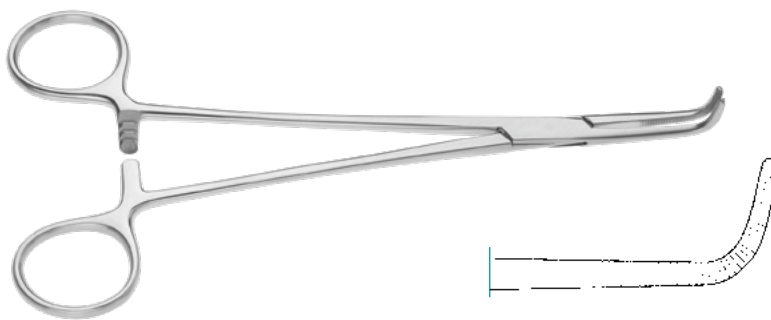

### **KANTROWITZ**

Thorax Forceps, serrated, curved

190mm, 7<sup>1</sup>/<sub>2</sub>" 140-417-190

240mm, 9<sup>1</sup>/<sub>2</sub>" 140-417-240

280mm, 11" 140-417-280

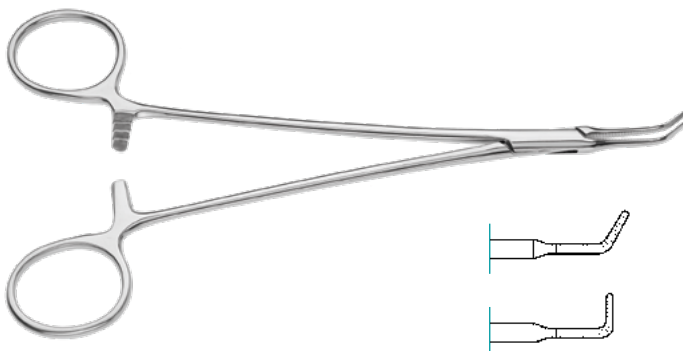

### **BAILEY**

Hemostatic Forceps, very fine jaw, serrated,  
60° angled, polished jaw

200mm, 8" 140-144-060

90° angled

180mm, 7" 140-144-090



### MICRO ADSON

Dissecting Forceps, curved

140mm, 5<sup>1/2</sup>"

140-338-140



### BABY ADSON

Dissecting Forceps, curved

140mm, 5<sup>1/2</sup>"

140-339-140

180mm, 7"

140-339-180

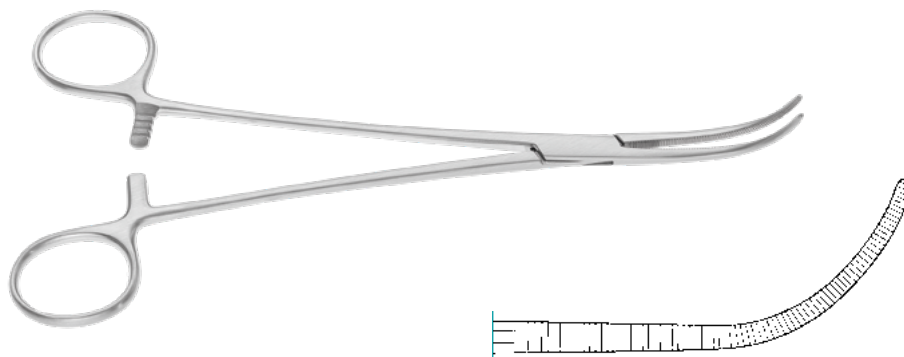

### OVERHOLT MIXTER

Ligature Forceps, curved

210mm, 8<sup>1/4</sup>"

140-345-210

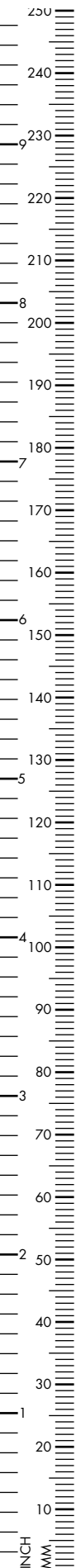

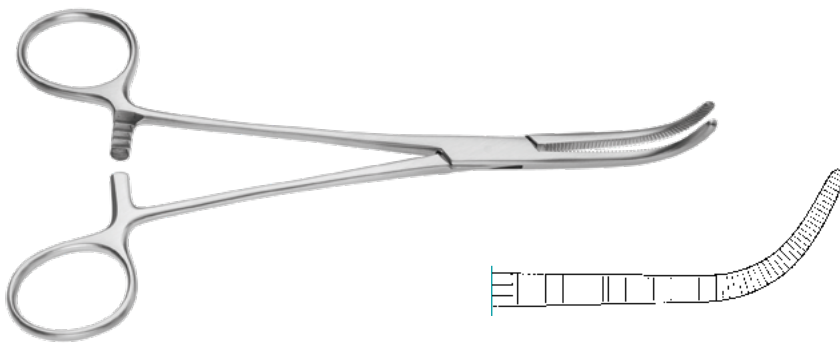

### MIXER O'SHAUGHNESSY

Hemostatic Forceps, curved

155mm, 6<sup>1</sup>/<sub>8</sub>" 140-425-155

190mm, 7<sup>1</sup>/<sub>2</sub>" 140-425-190

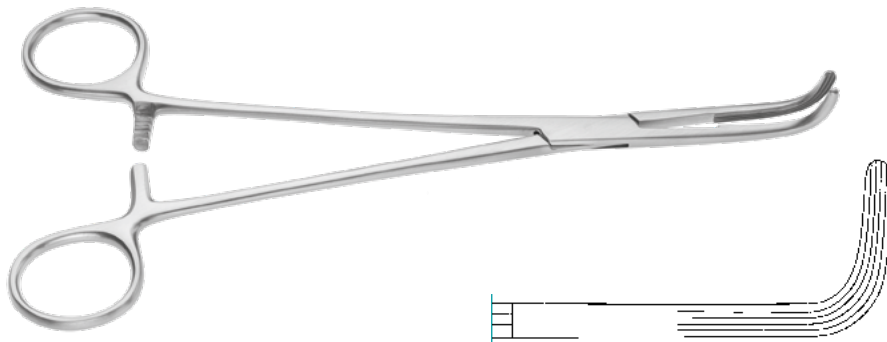

### MIXER

Gall Duct Clamp, longitudinal serrations

220mm, 8<sup>2</sup>/<sub>3</sub>" 140-433-220

250mm, 9<sup>7</sup>/<sub>8</sub>" 140-433-250

280mm, 11" 140-433-280

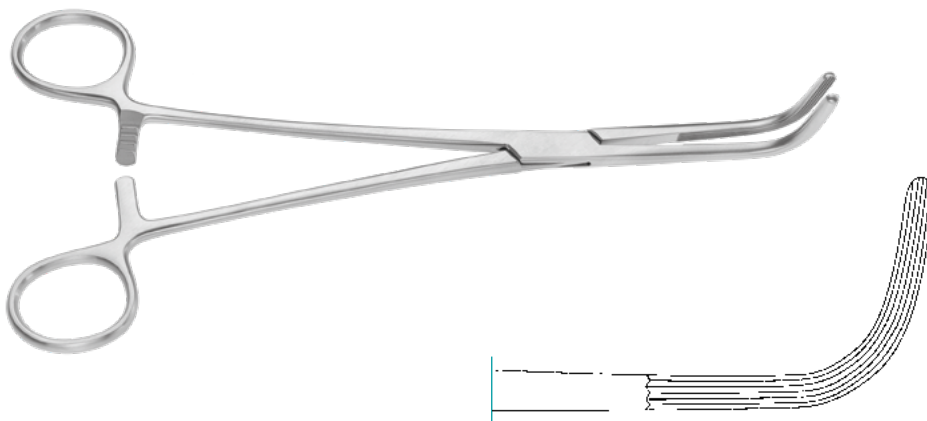

### MCQUIGG MIXER

Hemostatic Forceps, longitudinal serration

220mm, 8<sup>2</sup>/<sub>3</sub>" 140-435-220



### FINOCHIETTO

Ligature Forceps, longitudinal serrations, with hole

240mm, 9<sup>1</sup>/<sub>2</sub>"

140-440-240

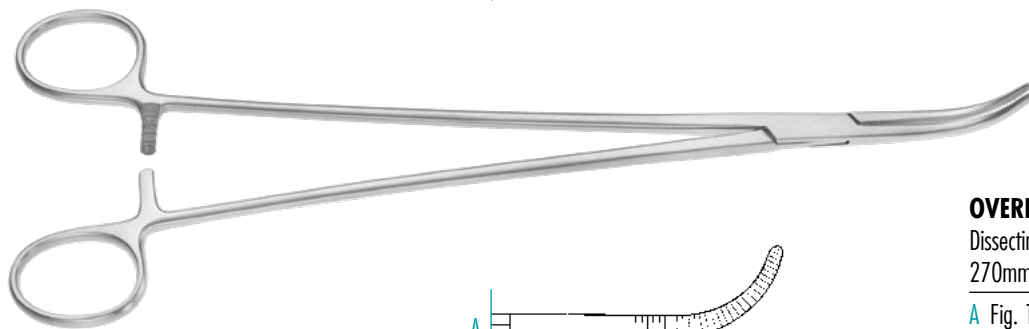
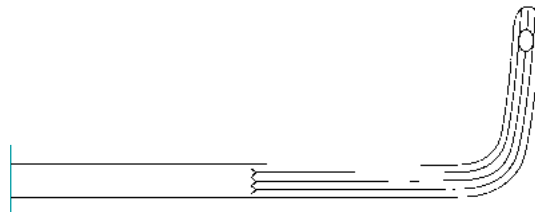

### OVERHOLT GEISENDOERFER

Dissecting - and Ligature Forceps

270mm, 10<sup>2</sup>/<sub>3</sub>"

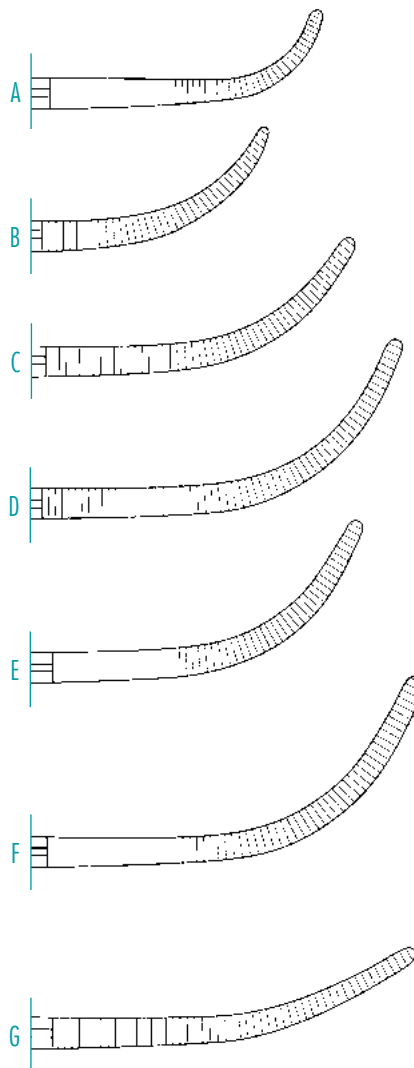

- |          |             |
|----------|-------------|
| A Fig. 1 | 140-447-001 |
| B Fig. 2 | 140-447-002 |
| C Fig. 3 | 140-447-003 |
| D Fig. 4 | 140-447-004 |
| E Fig. 5 | 140-447-005 |
| F Fig. 6 | 140-447-006 |
| G Fig. 7 | 140-447-007 |

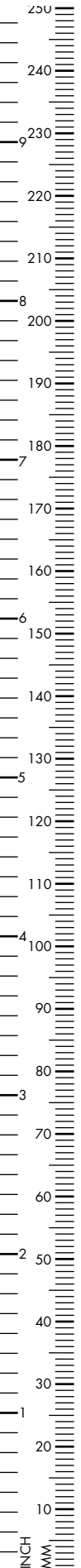

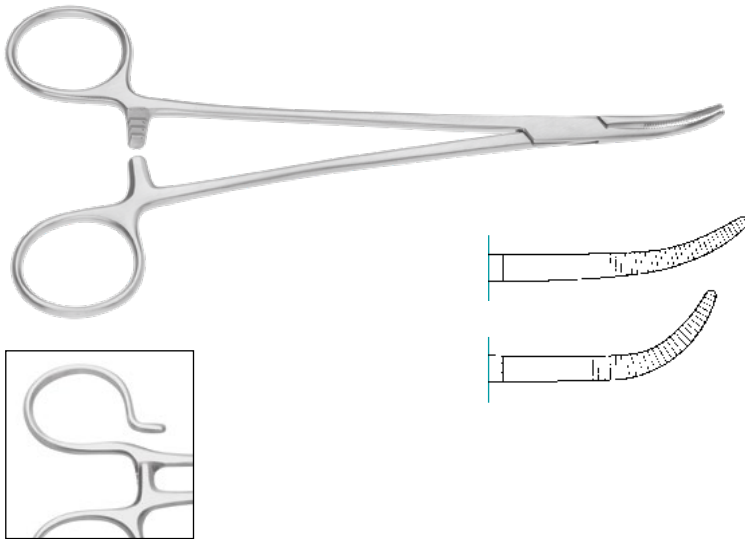

### SCHNIDT SAWTELL

Tonsil Seizing Forceps, slightly curved

190mm, 7<sup>1/2</sup>" 140-628-190

strongly curved

190mm, 7<sup>1/2</sup>" 140-629-190

slightly curved, with one open ring

190mm, 7<sup>1/2</sup>" 140-630-190

strongly curved, with one open ring

190mm, 7<sup>1/2</sup>" 140-631-190

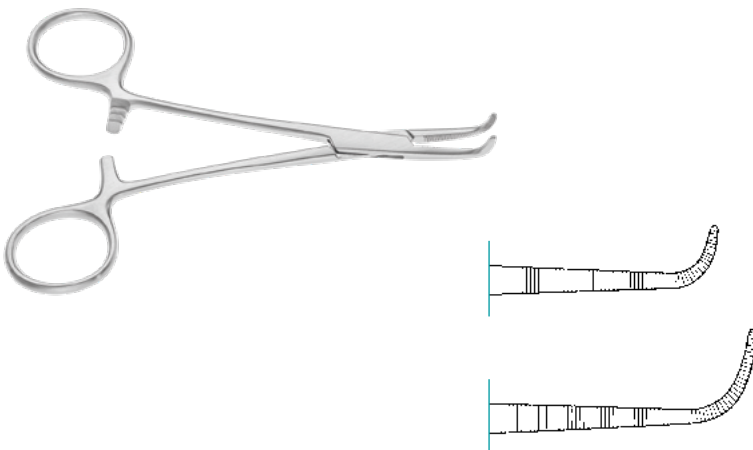

### MINI GEMINI

Dissecting Forceps, fully serrated, curved

130mm, 5<sup>1/8</sup>" 140-359-130

160mm, 6<sup>1/4</sup>" 140-359-160

180mm, 7" 140-359-180

200mm, 8" 140-359-200

220mm, 8<sup>2/3</sup>" 140-359-220

230mm, 9" 140-359-230

250mm, 9<sup>7/8</sup>" 140-359-250

280mm, 11" 140-359-280

### GEMINI

Dissecting Forceps, fully serrated, curved

130mm, 5<sup>1/8</sup>" 140-361-130

160mm, 6<sup>1/4</sup>" 140-361-160

180mm, 7" 140-361-180

200mm, 8" 140-361-200

220mm, 8<sup>2/3</sup>" 140-361-220

230mm, 9" 140-361-230

250mm, 9<sup>7/8</sup>" 140-361-250

280mm, 11" 140-361-280

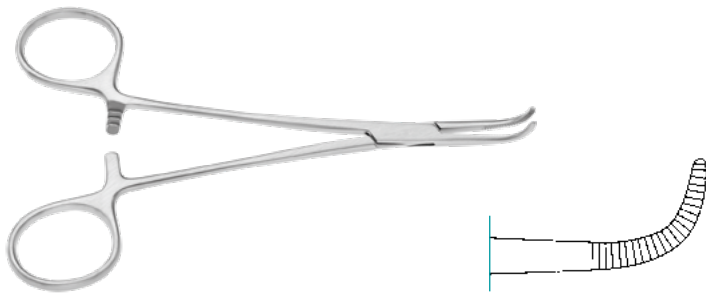

### PETIT POINT MIXER

Artery Forceps, 90° angled

140mm, 5<sup>1</sup>/<sub>2</sub>" 140-373-140

180mm, 7" 140-373-180

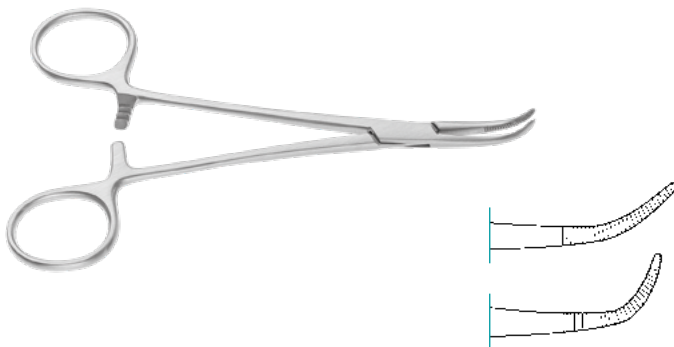

### BABY MIXER

Artery Forceps, slightly curved

140mm, 5<sup>1</sup>/<sub>2</sub>" 140-244-140

strongly curved

140mm, 5<sup>1</sup>/<sub>2</sub>" 140-245-140

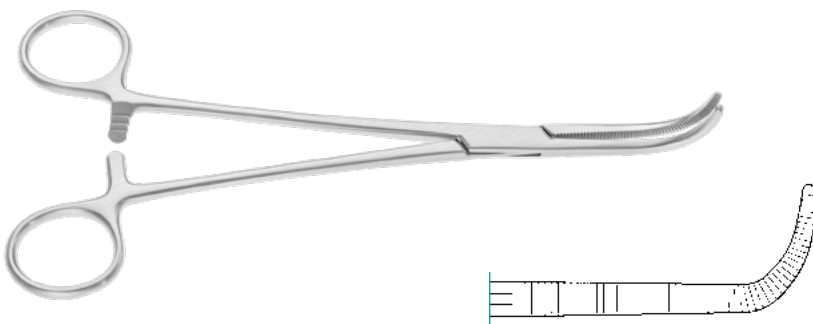

### MIXER

Forceps, fully serrated

155mm, 6<sup>1</sup>/<sub>8</sub>" 140-423-155

190mm, 7<sup>1</sup>/<sub>2</sub>" 140-423-190

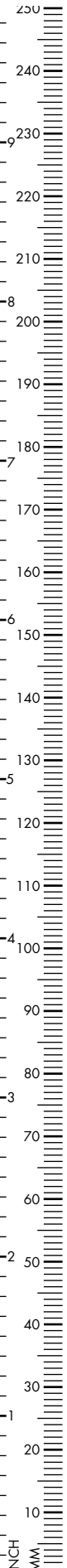

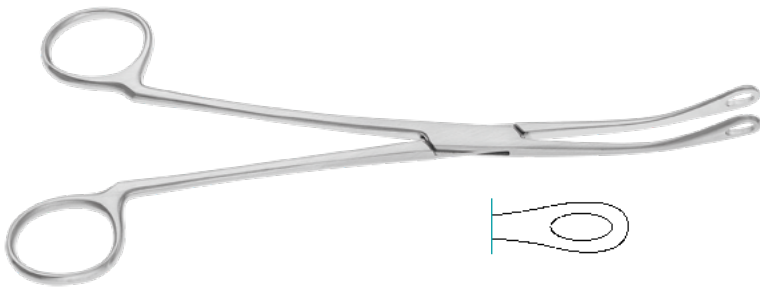

### BLAKE

Gall Stone Forceps, 200mm, 8"

straight	320-117-200
curved	320-116-200

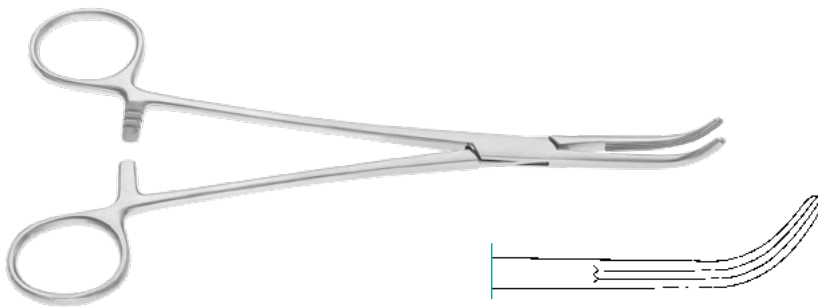

### LAHEY

Gall Duct Forceps, curved, longitudinal serration

190mm, 7 <sup>1</sup> / <sub>2</sub> "	140-439-190
190mm, 7 <sup>1</sup> / <sub>2</sub> ", fine tip	140-432-190
230mm, 9"	140-439-230

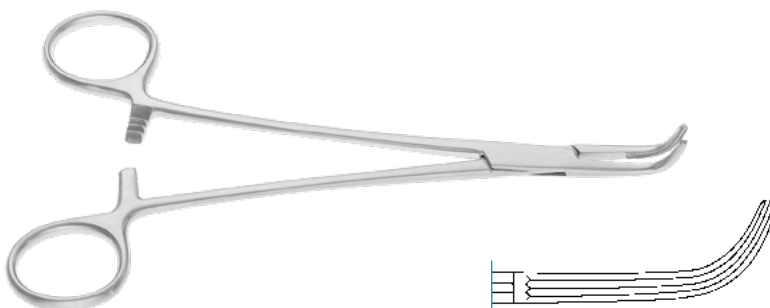

### LOWER

Gall Duct Forceps, curved, longitudinal serration

185mm, 7 <sup>1</sup> / <sub>4</sub> "	140-437-180
--	-------------



### PETIT ALLIS

Tissue Forceps, 2x3 teeth

120mm, 4 <sup>3</sup> / <sub>4</sub> "	310-008-120
--	-------------

150mm, 6"	310-008-150
-----------	-------------

3x4 teeth

120mm, 4 <sup>3</sup> / <sub>4</sub> "	310-009-120
--	-------------

150mm, 6"	310-009-150
-----------	-------------

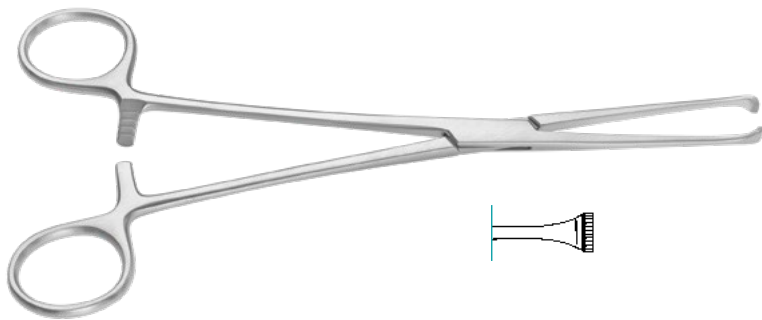

### ALLIS

Tissue Forceps, 5mm wide, 4x5 teeth

200mm, 8"	310-031-200
-----------	-------------



### BABY ALLIS

Tissue Forceps, 4x5 teeth

120mm, 4 <sup>3</sup> / <sub>4</sub> "	310-010-120
--	-------------

150mm, 6"	310-010-150
-----------	-------------

190mm, 7 <sup>1</sup> / <sub>2</sub> "	310-010-190
--	-------------





### ALLIS

Tissue Forceps, 7mm wide, 5x6 teeth

150mm, 6"	310-014-150
190mm, 7 <sup>1</sup> / <sub>2</sub> "	310-014-190
220mm, 8 <sup>2</sup> / <sub>3</sub> "	310-014-220
250mm, 9 <sup>7</sup> / <sub>8</sub> "	310-014-250



### ALLIS ATRAUMA

Tissue Forceps, 7.3mm wide

160mm, 6 <sup>1</sup> / <sub>4</sub> "	310-020-160
200mm, 8"	310-020-200
250mm, 9 <sup>7</sup> / <sub>8</sub> "	310-020-250



### JUDD ALLIS

Tissue Forceps, 3x4 teeth, 4mm wide

150mm, 6"	310-028-150
4.3mm wide	
190mm, 7 <sup>1</sup> / <sub>2</sub> "	310-026-190

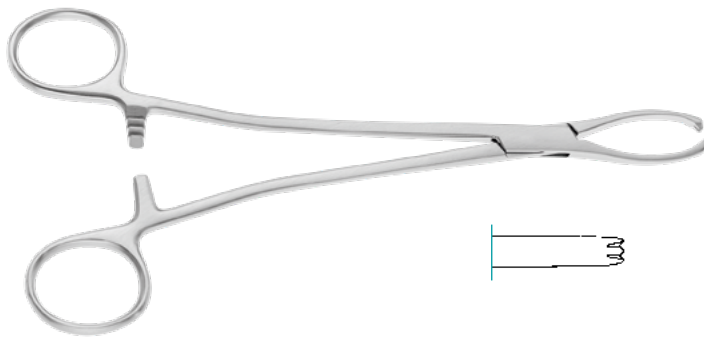

### LITTLEWOOD

Tissue Forceps, 2x3 teeth

185mm, 7<sup>1</sup>/<sub>4</sub>"

310-025-185



### ALLIS ADAIR

Tissue Forceps, 9x10 teeth, 10mm wide

155mm, 6<sup>1</sup>/<sub>8</sub>"

310-027-155

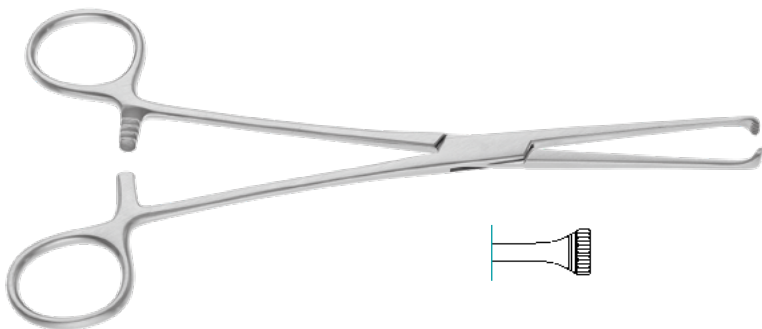

### THOMS ALLIS

Tissue Forceps, 6x7 teeth, 7.25mm wide

200mm, 8"

310-030-200

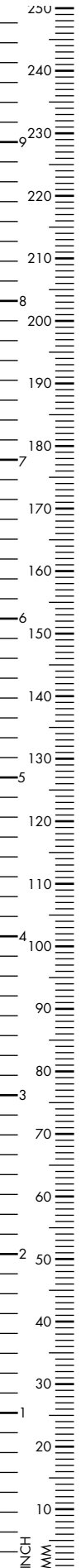



### BOYS ALLIS

Tissue Grasping Forceps, 5x6 teeth,  
5.2mm wide

155mm, 6<sup>1/8</sup>" 310-029-155

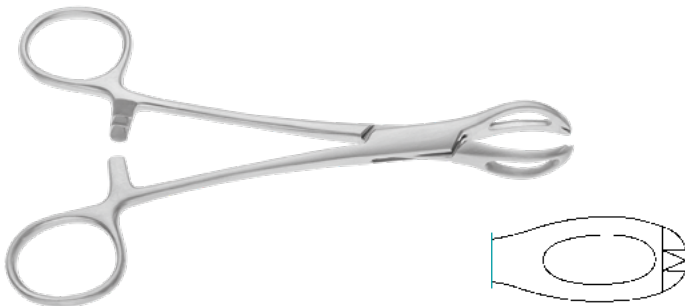

### LANE

Grasping Forceps, 1x2 teeth

150mm, 6" 310-030-150

195mm, 7<sup>3/4</sup>" 310-030-195

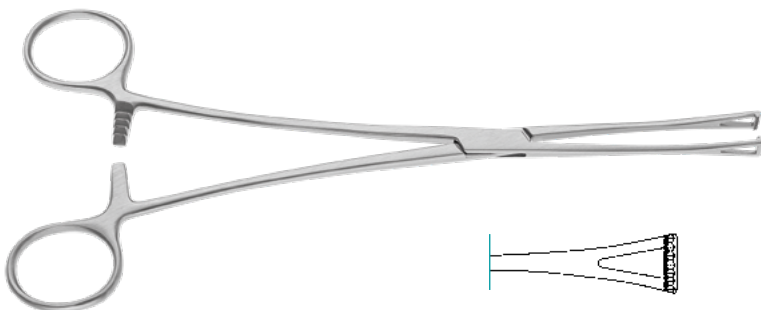

### LOCKWOOD

Intestinal Grasping Forceps, 6mm wide

200mm, 8" 310-100-200

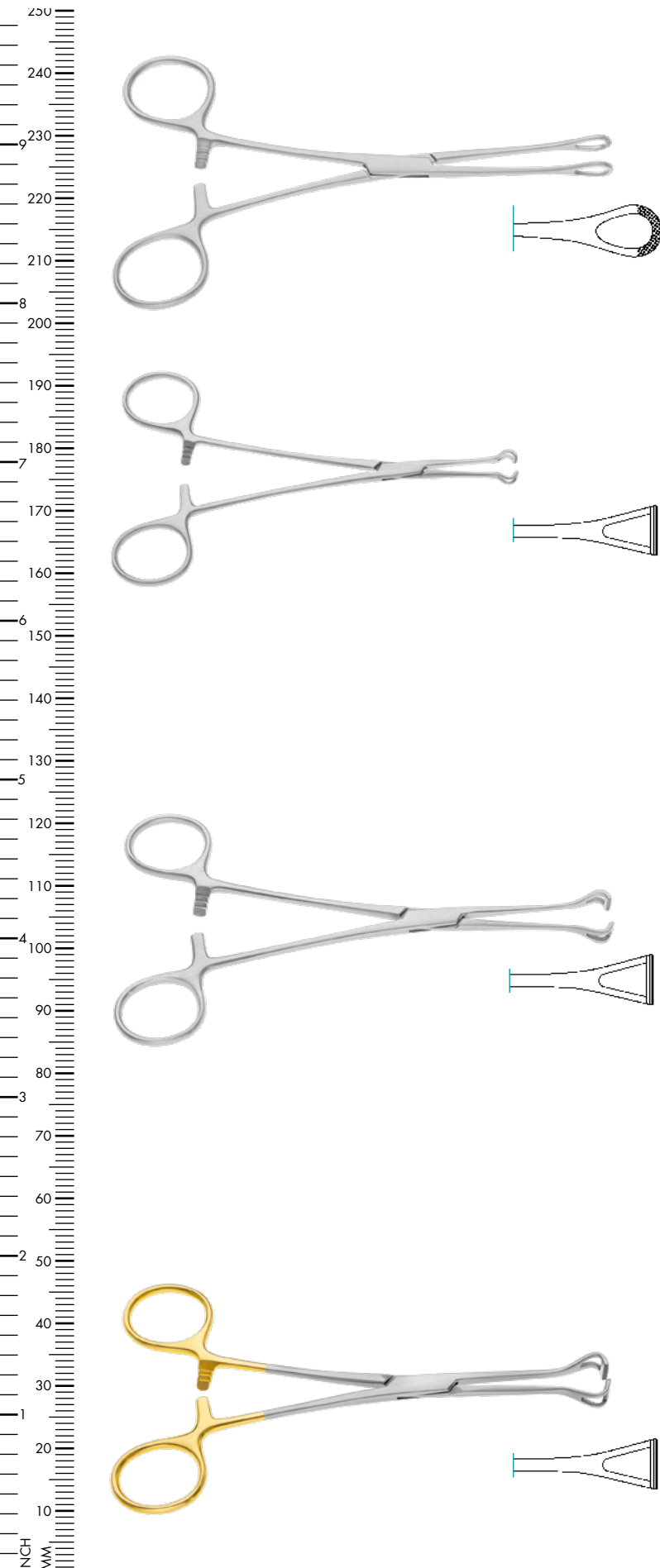

### **WILLIAMS**

Intestinal Grasping Forceps, cross-serrated jaw  
160mm, 6<sup>1/4</sup>" 310-115-160

### **PETIT BABCOCK**

Intestinal Grasping Forceps, 5mm wide  
130mm, 5<sup>1/8</sup>" 310-105-130

5.6mm wide  
150mm, 6" 310-105-150

7.5mm wide  
155mm, 6<sup>1/8</sup>" 310-105-155

### **BABCOCK**

Tissue Forceps, 8mm wide  
160mm, 6<sup>1/4</sup>" 310-110-160

10.5mm wide  
180mm, 7" 310-110-180

11mm wide  
200mm, 8" 310-110-200

11.8mm wide  
240mm, 9<sup>1/2</sup>" 310-110-240

11.5mm wide  
300mm, 11<sup>7/8</sup>" 310-110-300

12mm wide  
355mm, 14" 310-110-355

### **TC BABCOCK**

Tissue Forceps, 8.5mm wide  
160mm, 6<sup>1/4</sup>" 310-118-160

10.5mm wide  
200mm, 8" 310-118-200



### BABCOCK ATRAUMA

Tissue Forceps

160mm, 6 <sup>1/4</sup> "	310-111-160
200mm, 8"	310-111-200

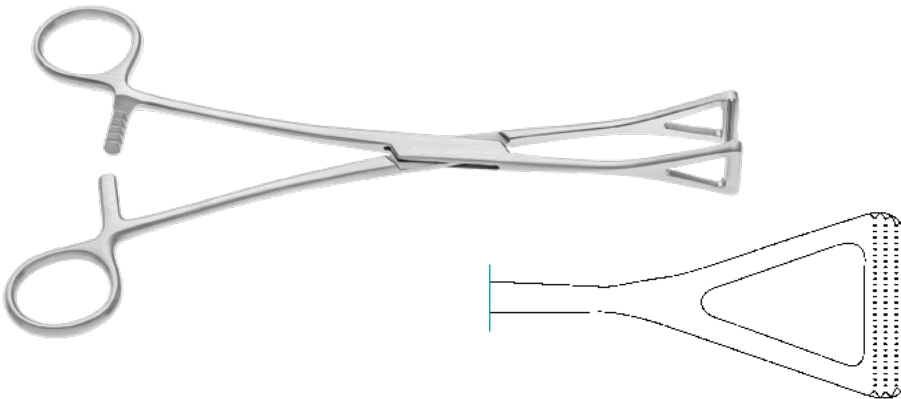

### COLLIN ATRAUMA

Tissue Forceps

195mm, 7 <sup>3/4</sup> "	310-295-195
230mm, 9"	310-295-230

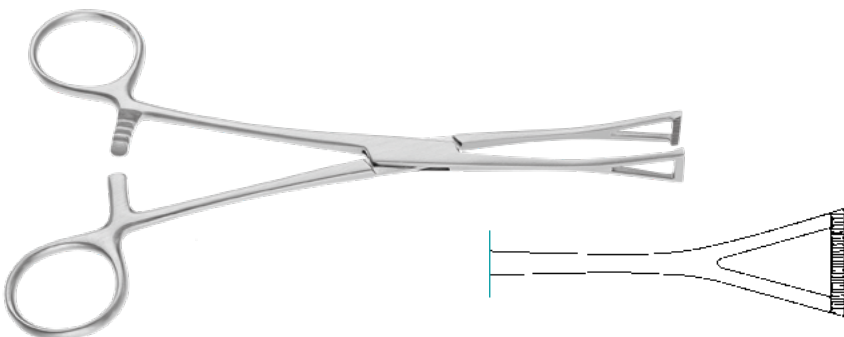

### DUVAL

Tissue Forceps, 16mm wide

180mm, 7"	310-112-180
200mm, 8"	310-112-200

26mm wide

200mm, 8"	310-114-200
230mm, 9"	310-114-230

### TC DUVAL

200mm, 8"	310-113-200
-----------	-------------

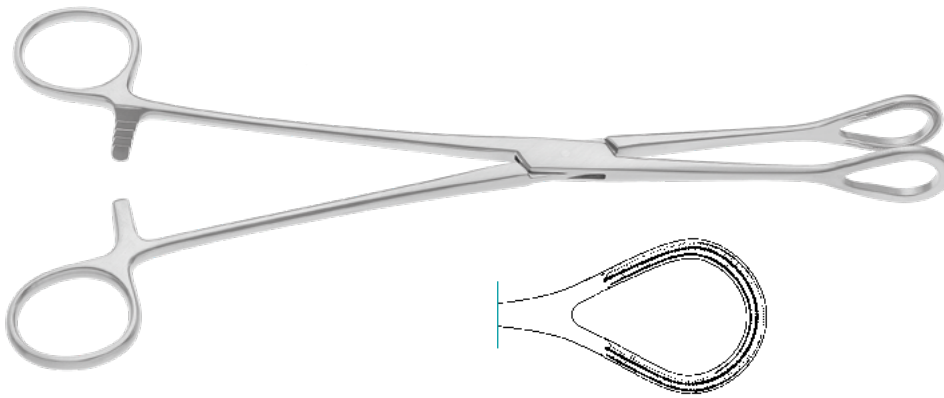
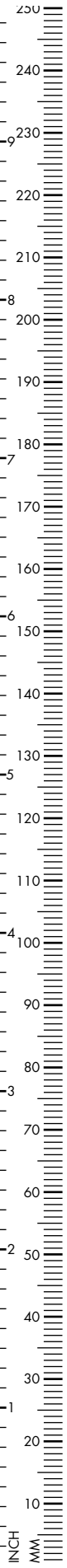

### DEBAKEY ATRAUMA

Intestinal and Organ Grasping Forceps,  
atraumatic serrations, small ring

250mm, 9<sup>7</sup>/<sub>8</sub>" 140-220-250

large ring

260mm, 10<sup>1</sup>/<sub>4</sub>" 140-220-260



Tobacco Pouch  
Colon Rectal Clamp

280mm, 11" 310-500-280



### BENSON

Polyrus Spreader

155mm, 6<sup>1</sup>/<sub>8</sub>" 310-116-140

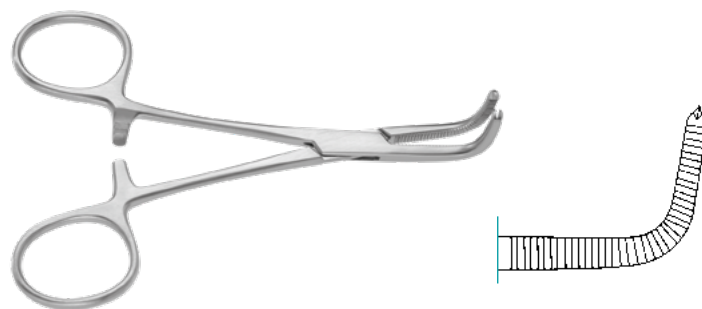

### KLEINSCHMIDT

Appendectomy Clamp, 90° angled jaw

130mm, 5<sup>1</sup>/<sub>8</sub>" 140-397-130

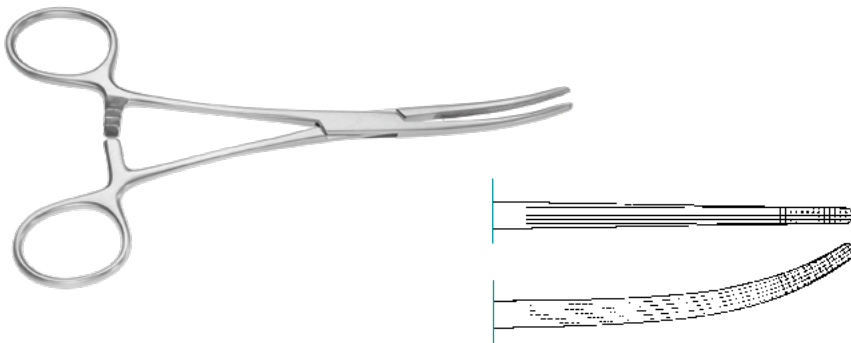

### BAINBRIDGE

longitudinal serrations, cross-serrated tip,  
straight

150mm, 6" 140-442-150

185mm, 7<sup>1/4</sup>" 140-442-185

curved

150mm, 6" 140-443-150

185mm, 7<sup>1/4</sup>" 140-443-185

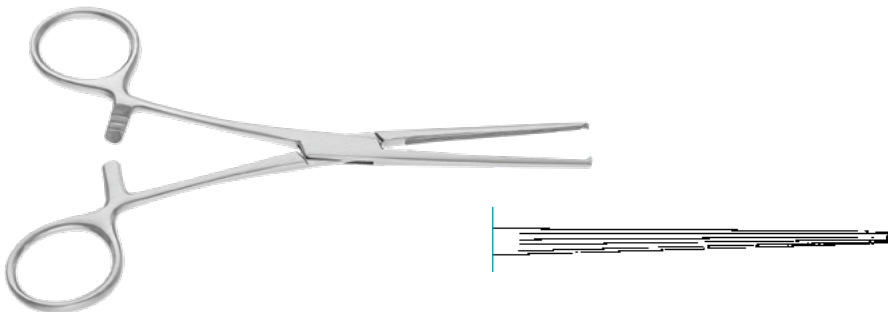

### ALLEN

Intestinal Clamp, longitudinal serrations,  
for children, 1x2 teeth

155mm, 6<sup>1/8</sup>" 310-116-155

200mm, 8" 310-116-200

230mm, 9" 310-116-230

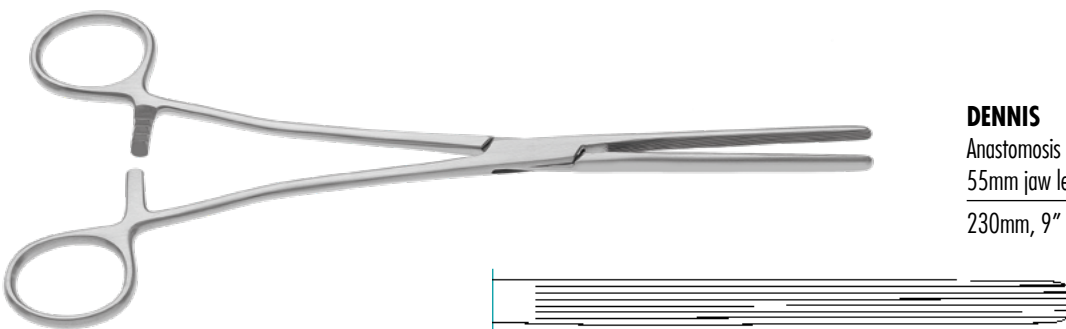

### DENNIS

Anastomosis Clamp, longitudinal serrations,  
55mm jaw length

230mm, 9" 310-117-230

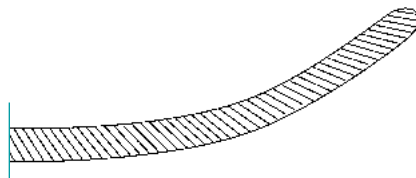
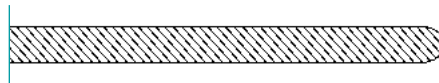
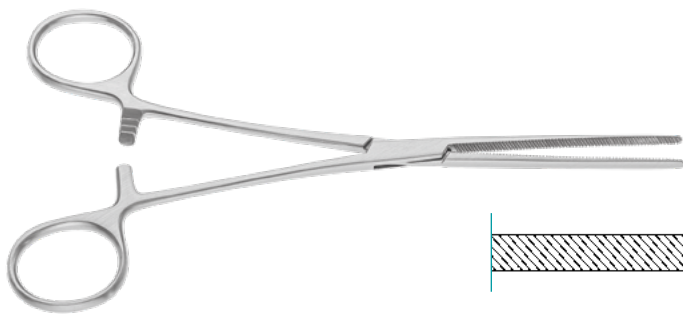

### BABY DOYEN

Intestinal Clamp, diagonal serrations, elastic  
180mm, 7"

straight	310-290-180
curved	310-291-180

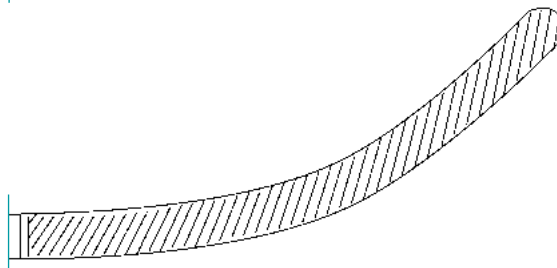
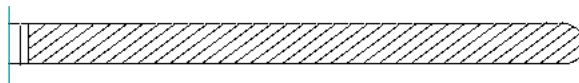
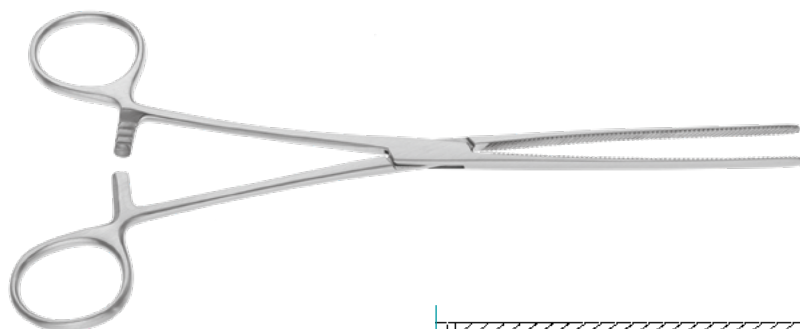

### DOYEN

Intestinal Clamp, diagonal serrations, elastic,  
straight

210mm, 8 <sup>1</sup> / <sub>4</sub> "	310-290-210
230mm, 9"	310-290-230

curved	
210mm, 8 <sup>1</sup> / <sub>4</sub> "	310-291-210
230mm, 9"	310-291-230

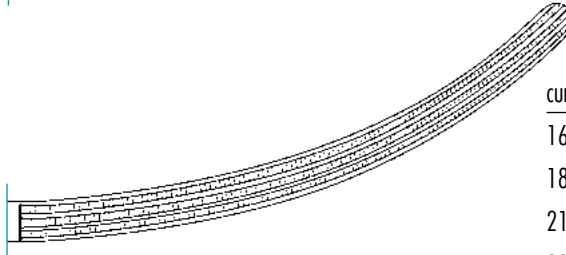
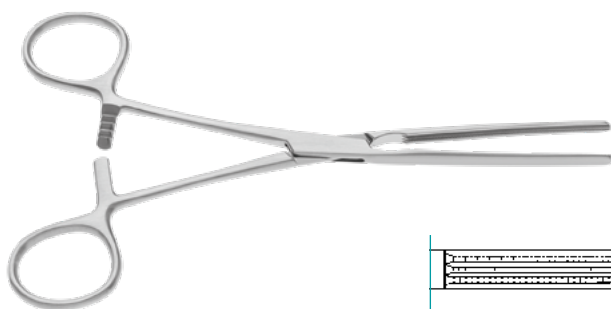

### DOYEN ATRAUMATIC

Intestinal Clamp, atraumatic elastic serrations,  
straight

160mm, 6 <sup>1</sup> / <sub>4</sub> "	310-550-160
180mm, 7"	310-550-180
210mm, 8 <sup>1</sup> / <sub>4</sub> "	310-550-210
230mm, 9"	310-550-230

curved	
160mm, 6 <sup>1</sup> / <sub>4</sub> "	310-551-160
180mm, 7"	310-551-180
210mm, 8 <sup>1</sup> / <sub>4</sub> "	310-551-210
230mm, 9"	310-551-230

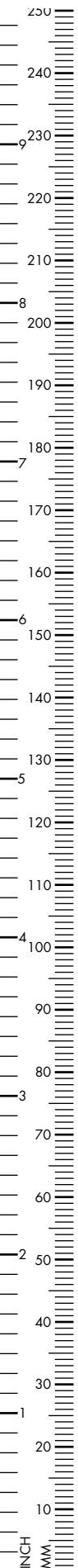



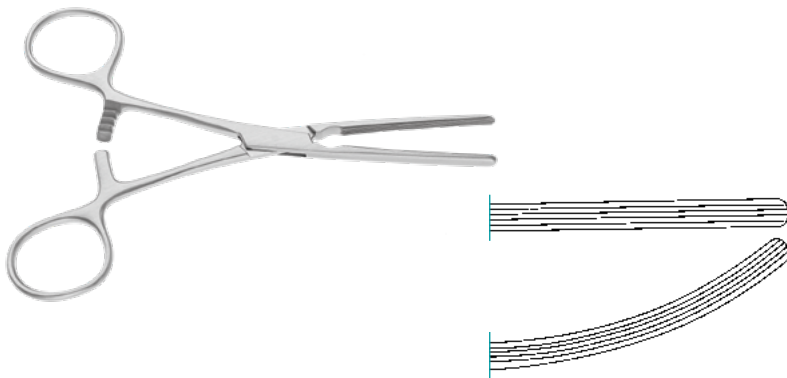

### BABY KOCHER

Intestinal Clamp, longitudinal serrations  
130mm, 5<sup>1/8</sup>"

straight	310-124-130
curved	310-125-130

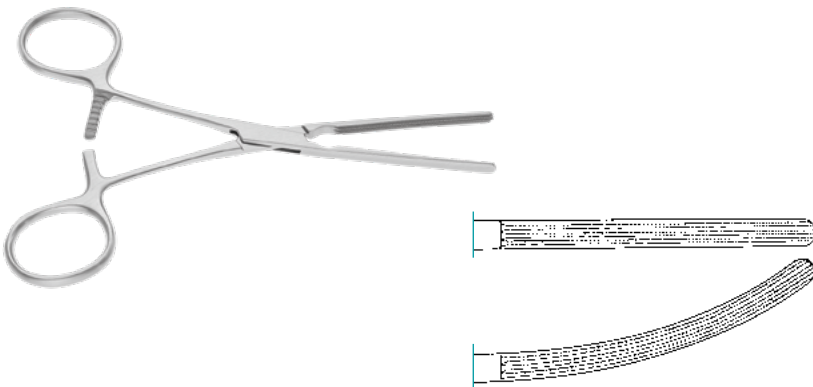

### BABY KOCHER

Intestinal Clamp, atraumatic elastic serrations,  
130mm, 5<sup>1/8</sup>"

straight	310-200-130
curved	310-201-130

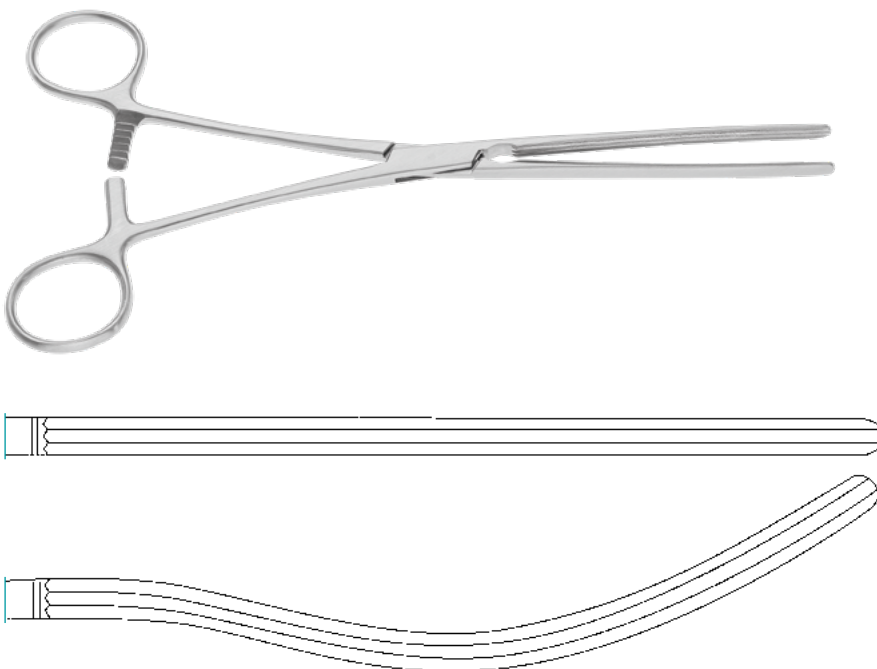

### KOCHER

Intestinal Clamp, longitudinal serrations, elastic,  
straight

220mm, 8 <sup>2/3</sup> "	310-124-220
250mm, 9 <sup>7/8</sup> "	310-124-250
280mm, 11"	310-124-280

curved	
220mm, 8 <sup>2/3</sup> "	310-125-220
250mm, 9 <sup>7/8</sup> "	310-125-250
280mm, 11"	310-125-280

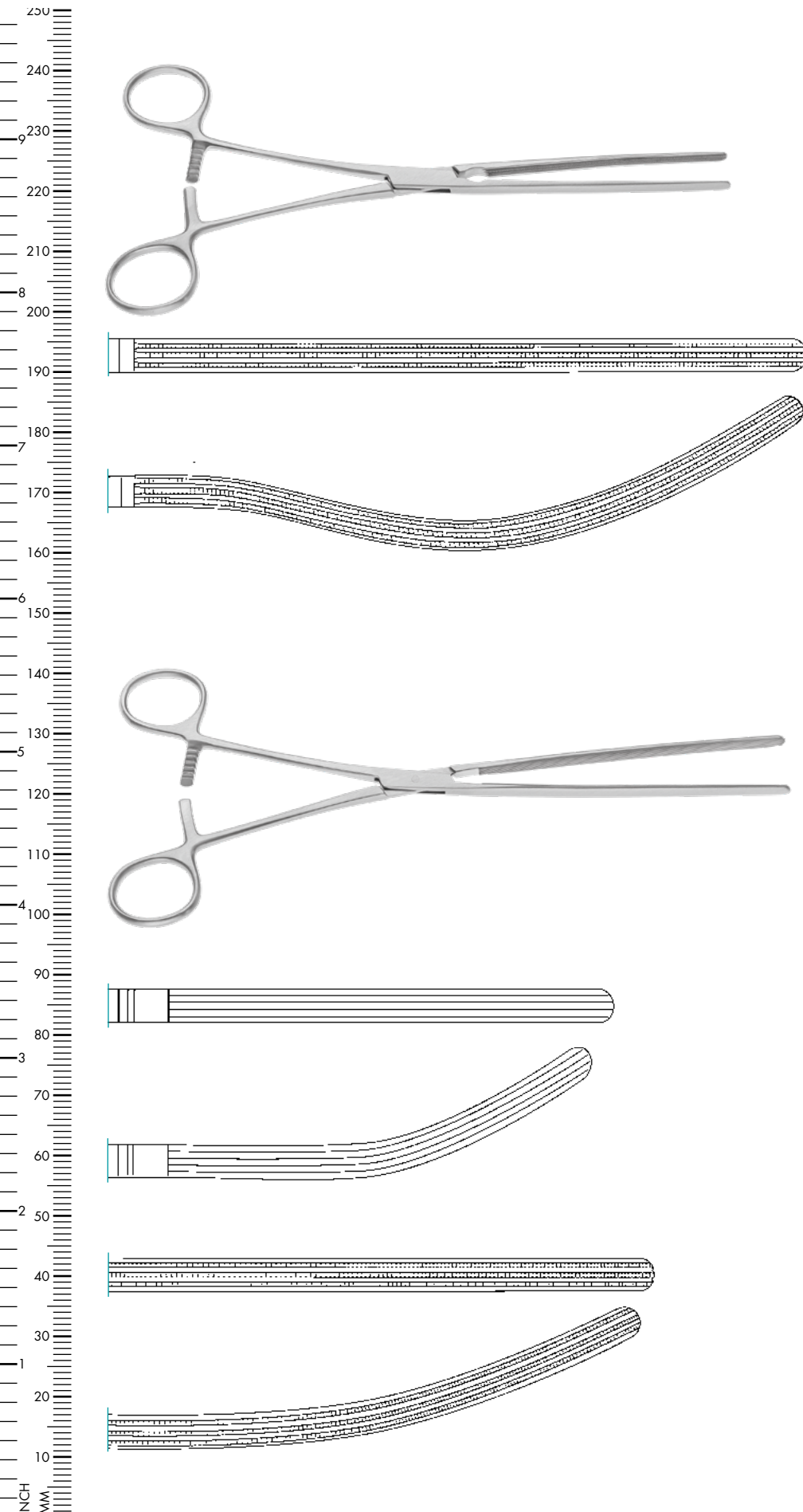

### KOCHER ATRAUMATIC

Intestinal Clamp, atraumatic, elastic serrations, straight

220mm, 8 <sup>2</sup> / <sub>3</sub> "	310-126-220
250mm, 9 <sup>7</sup> / <sub>8</sub> "	310-126-250
280mm, 11"	310-126-280

curved

220mm, 8 <sup>2</sup> / <sub>3</sub> "	310-127-220
250mm, 9 <sup>7</sup> / <sub>8</sub> "	310-127-250
280mm, 11"	310-127-280

### MAYO ROBSON

Intestinal Clamp, longitudinal serrations straight

210mm, 8 <sup>1</sup> / <sub>4</sub> "	310-130-210
230mm, 9"	310-130-230
250mm, 9 <sup>7</sup> / <sub>8</sub> "	310-130-250

curved

210mm, 8 <sup>1</sup> / <sub>4</sub> "	310-131-210
230mm, 9"	310-131-230
250mm, 9 <sup>7</sup> / <sub>8</sub> "	310-131-250

### MAYO ROBSON ATRAUMATIC

Intestinal Clamp, atraumatic, elastic serrations straight

210mm, 8 <sup>1</sup> / <sub>4</sub> "	310-140-210
230mm, 9"	310-140-230
250mm, 9 <sup>7</sup> / <sub>8</sub> "	310-140-250

curved

210mm, 8 <sup>1</sup> / <sub>4</sub> "	310-141-210
230mm, 9"	310-141-230
250mm, 9 <sup>7</sup> / <sub>8</sub> "	310-141-250

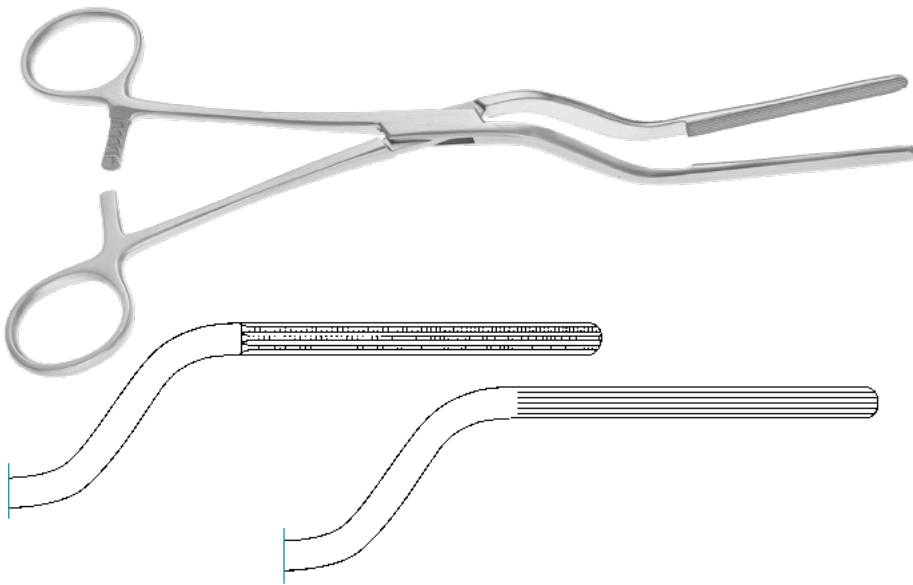

### BRUNNER

Intestinal Clamp, bayonet shaped,  
240mm, 9<sup>1/2</sup>"

atraumatic serrations	310-151-240
longitudinal serrations	310-150-240

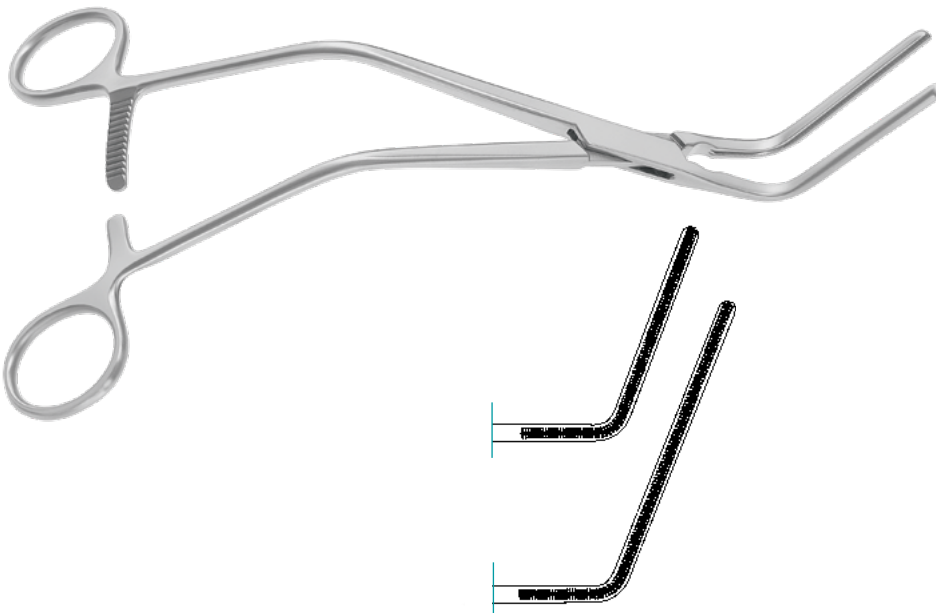

### HAYES ATRAUMATIC

Intestinal Clamp, 60mm jaw

270mm, 10 <sup>2/3</sup> "	310-310-260
85mm jaw	
280mm, 11"	310-310-280

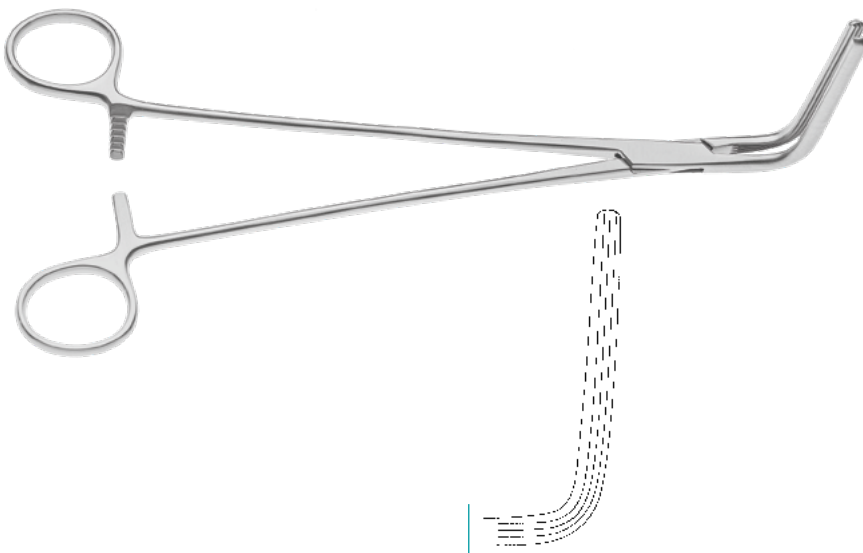

### ZUBROD

Intestinal Clamp, longitudinal serrations,  
60mm jaw, 90° angled

230mm, 9"	310-710-230
-----------	-------------

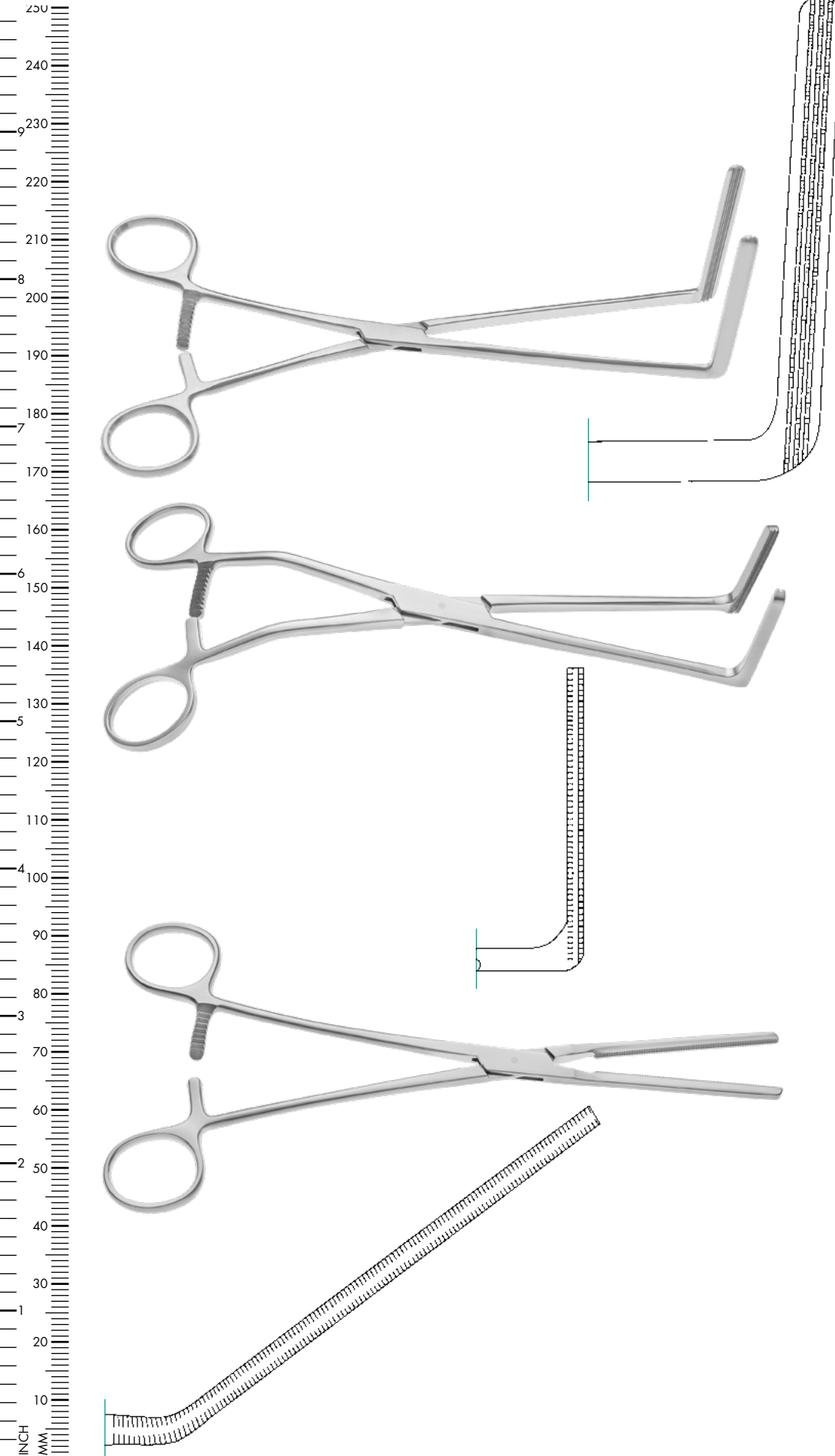

### FEHLAND

Intestinal Clamp, atraumatic serrations

250mm, 9<sup>7</sup>/<sub>8</sub>"

310-584-240

### GLASSMAN

Intestinal Clamp, atraumatic serrations,  
235mm, 9<sup>1</sup>/<sub>4</sub>"

25mm jaw

310-199-235

50mm jaw

310-201-235

75mm jaw

310-203-235

### GLASSMAN

Intestinal Clamp, atraumatic serrations,  
65mm jaw length, straight

235mm, 9<sup>1</sup>/<sub>4</sub>"

310-200-235

115mm jaw length, straight

280mm, 11"

310-200-290

65mm jaw length, 25° angled

229mm, 9"

310-200-229

115mm jaw length, 45° angled

280mm, 11"

310-201-290

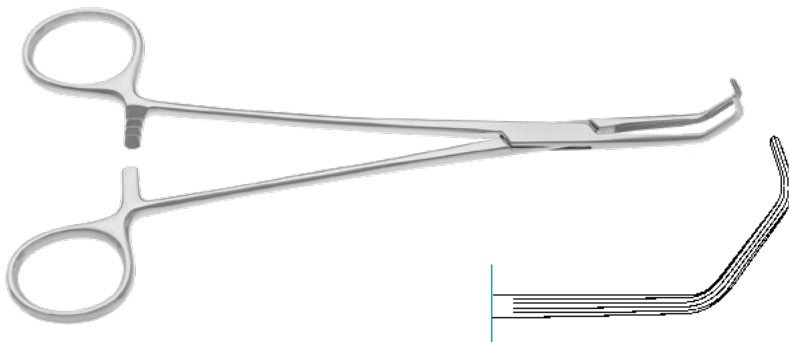

### HAUSMANN

Intestinal Clamp, straight shanks,  
1.9mm jaw width, 190mm, 7<sup>1</sup>/<sub>2</sub>"

22 x 8mm	310-233-190
----------	-------------

195mm, 7 <sup>3</sup> / <sub>4</sub> "	
--	--

30 x 8mm	310-233-195
----------	-------------

205mm, 8 <sup>1</sup> / <sub>8</sub> "	
--	--

33 x 8mm	310-233-205
----------	-------------

38 x 8mm	310-243-205
----------	-------------

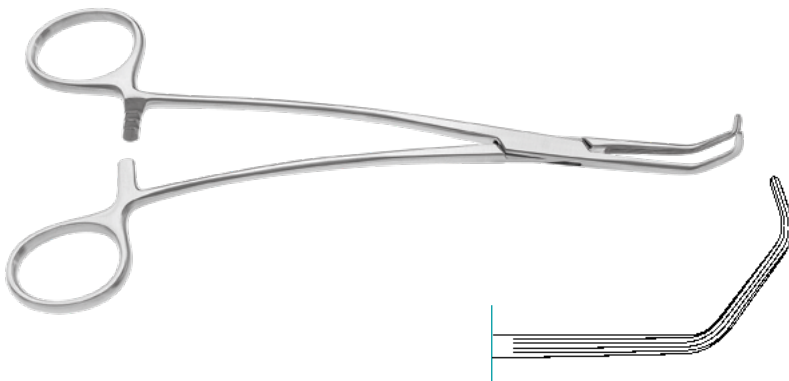

### HAUSMANN

Intestinal Clamp, angled shanks,  
1.9mm jaw width, 190mm, 7<sup>1</sup>/<sub>2</sub>"

22 x 8mm	310-231-190
----------	-------------

195mm, 7 <sup>3</sup> / <sub>4</sub> "	
--	--

30 x 8mm	310-231-195
----------	-------------

205mm, 8 <sup>1</sup> / <sub>8</sub> "	
--	--

33 x 8mm	310-231-205
----------	-------------

38 x 8mm	310-241-205
----------	-------------

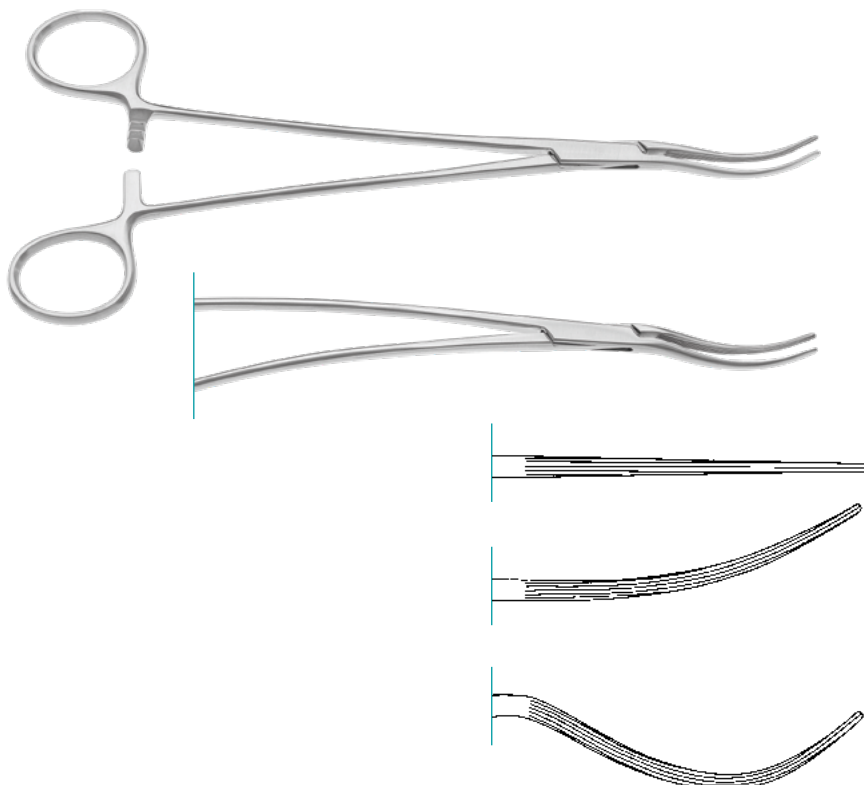

### HAUSMANN

Intestinal Clamp, straight shanks, 1.9mm jaw  
width, 215mm, 8<sup>1</sup>/<sub>2</sub>"

straight jaw	310-230-215
--------------	-------------

curved jaw	310-233-215
------------	-------------

strongly curved jaw	310-234-215
---------------------	-------------

angled shanks, 205mm, 8 <sup>1</sup> / <sub>8</sub> "	
---	--

straight jaw	310-250-205
--------------	-------------

angled shanks, 215mm, 8 <sup>1</sup> / <sub>2</sub> "	
---	--

curved jaw	310-253-215
------------	-------------

strongly curved jaw	310-254-215
---------------------	-------------

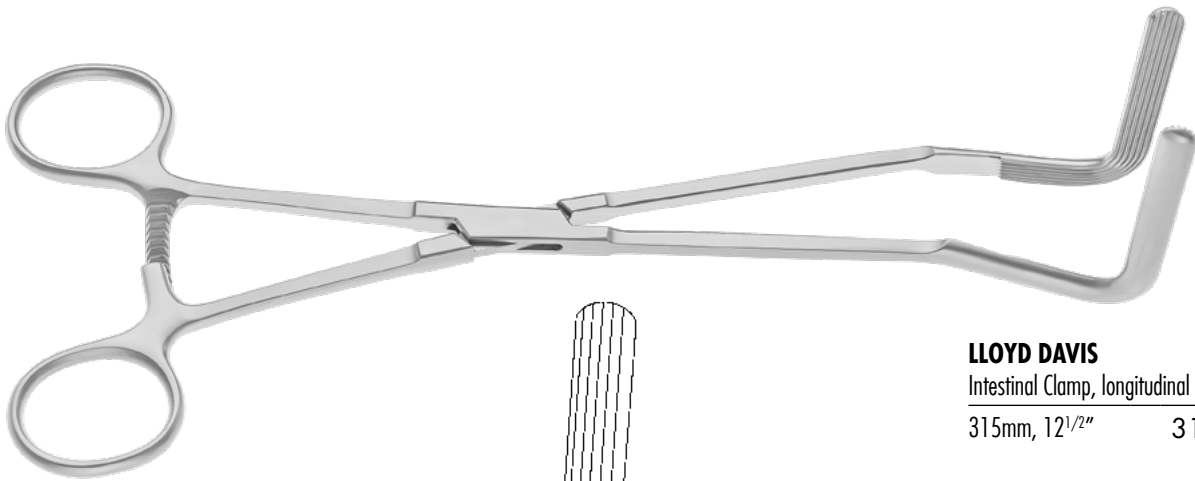

**LLOYD DAVIS**

Intestinal Clamp, longitudinal serrations

315mm, 12<sup>1/2</sup>"

310-154-315

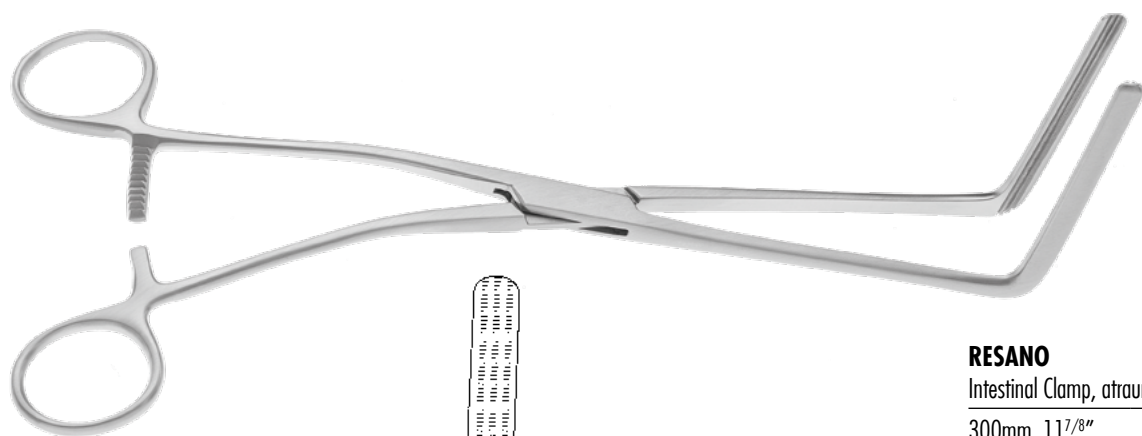
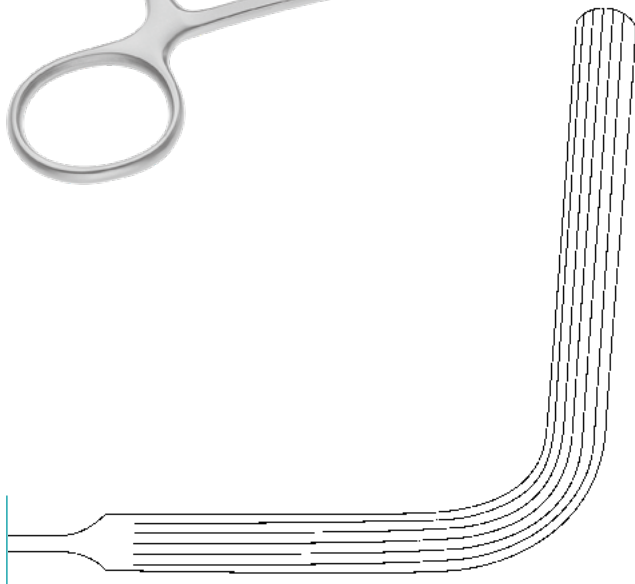

**RESANO**

Intestinal Clamp, atraumatic serrations

300mm, 11<sup>7/8</sup>"

310-580-300

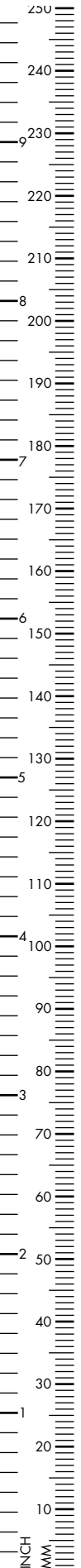
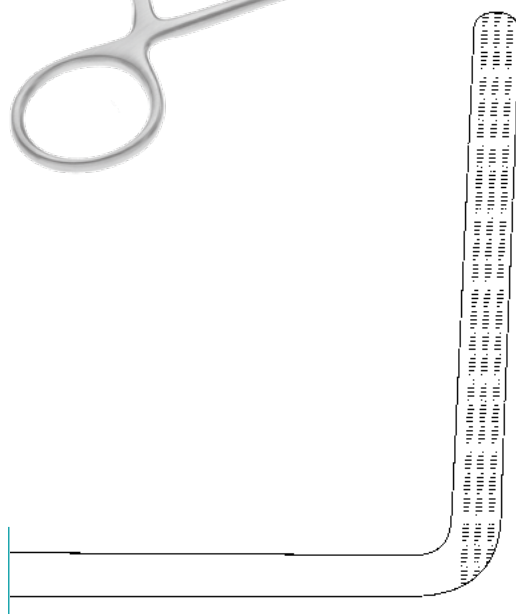



### DEMARTEL WOLFSON

Anastomosis Clamp

Set of 3 clamps

50mm	310-400-005
70mm	310-400-007
100mm	310-400-010



### DEMARTEL WOLFSON

Clamp Holder

85mm	310-410-085
225mm	310-410-225



### DEMARTEL WOLFSON

Closing Forceps

260mm	310-412-260
-------	-------------



**PAYR**

Pylorus Clamp, light model for children,  
with pin, 57mm jaw length

150mm, 6"

310-032-150

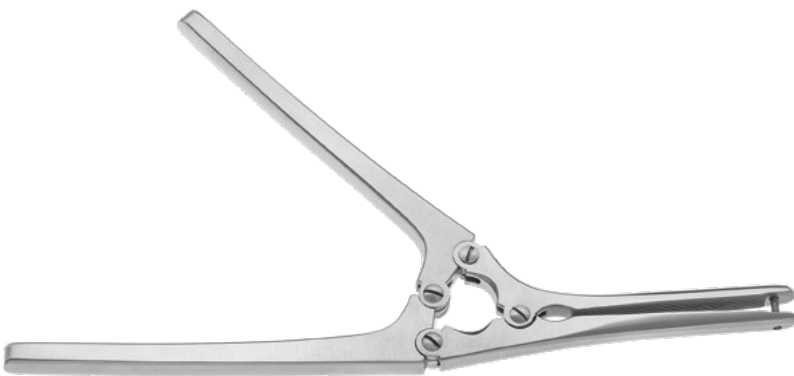
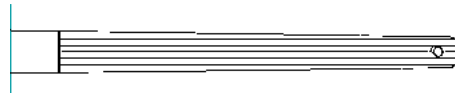

**PAYR**

Pylorus Clamp, with pin

210mm, 8<sup>1</sup>/<sub>4</sub>"

310-033-210

65mm jaw length

290mm, 11<sup>1</sup>/<sub>2</sub>"

310-033-290

105mm jaw length

315mm, 12<sup>1</sup>/<sub>2</sub>"

310-033-315

146mm jaw length

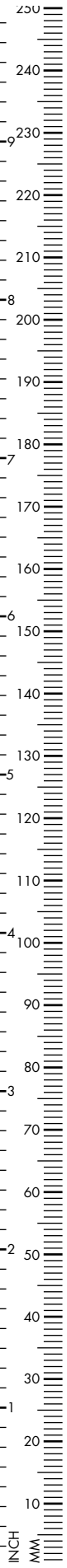
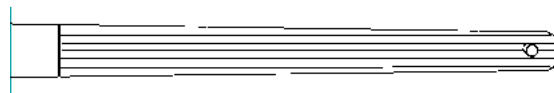



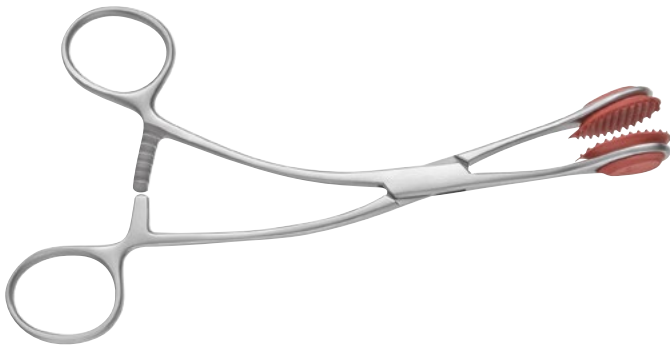

### YOUNG

Tongue Holding Forceps

170mm, 6<sup>2</sup>/<sub>3</sub>"

430-467-170

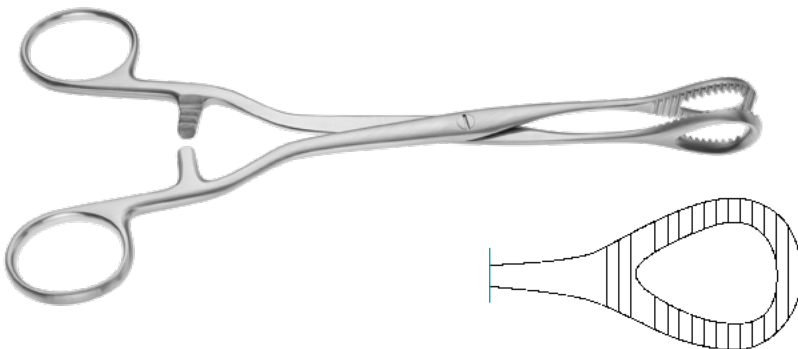

### HEYWOOD SMITH

Hemorrhoidal Forceps  
fenestrated serrated jaws

200mm, 8"

340-150-200

210mm, 8<sup>1</sup>/<sub>4</sub>"

340-160-210

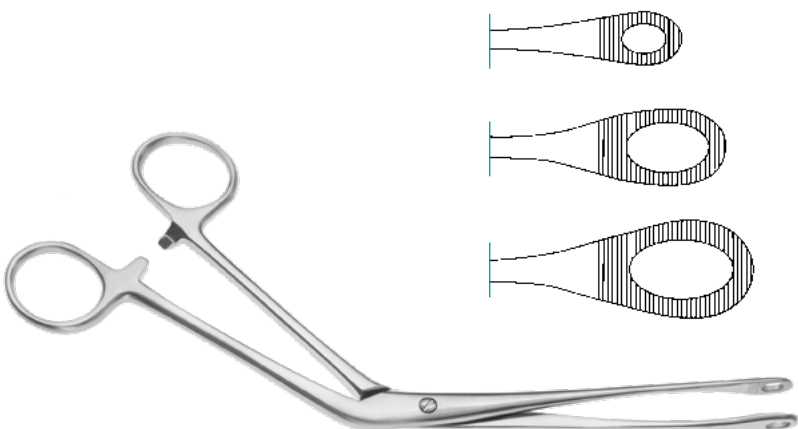

### TOENNIS

Tumor Grasping Forceps

Fig. 1

250-066-341

Fig. 2

250-066-342

Fig. 3

250-066-343

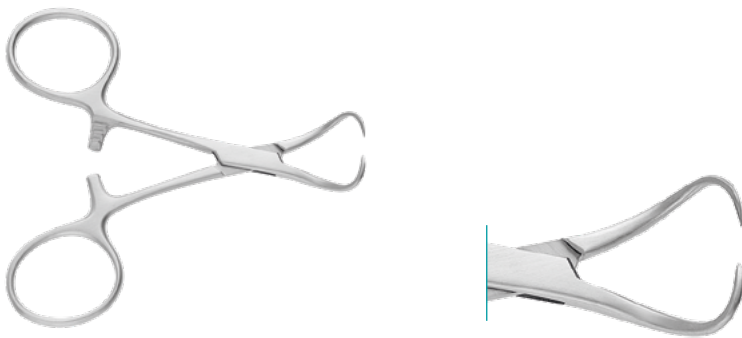
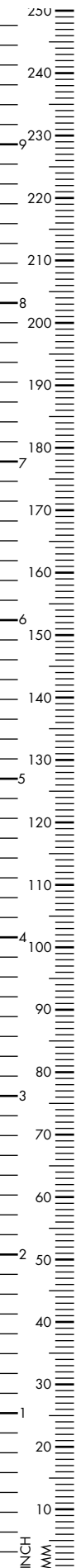

### BACKHAUS

Towel Forceps

90mm, 3 <sup>1</sup> / <sub>2</sub> "	140-573-090
110mm, 4 <sup>1</sup> / <sub>3</sub> "	140-573-110
130mm, 5 <sup>1</sup> / <sub>8</sub> "	140-573-130
150mm, 6"	140-573-150

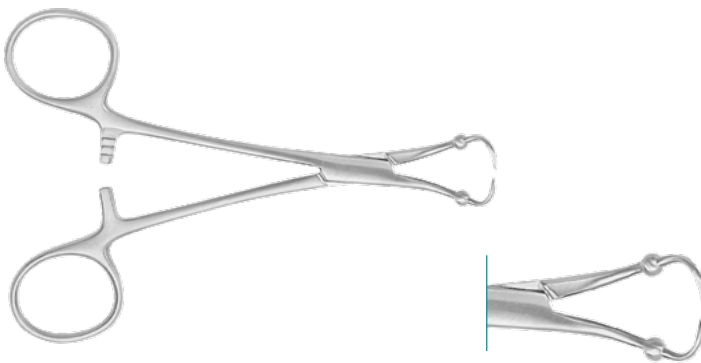

### ROEDER

Towel Forceps

130mm, 5 <sup>1</sup> / <sub>8</sub> "	140-579-130
--	-------------

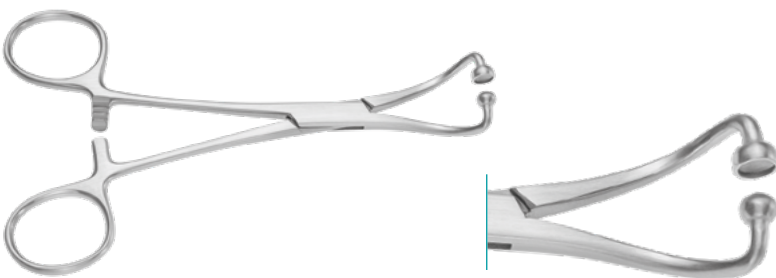

### Ball & Socket Towel Forceps

110mm, 4 <sup>1</sup> / <sub>3</sub> "	140-580-115
130mm, 5 <sup>1</sup> / <sub>8</sub> "	140-580-130

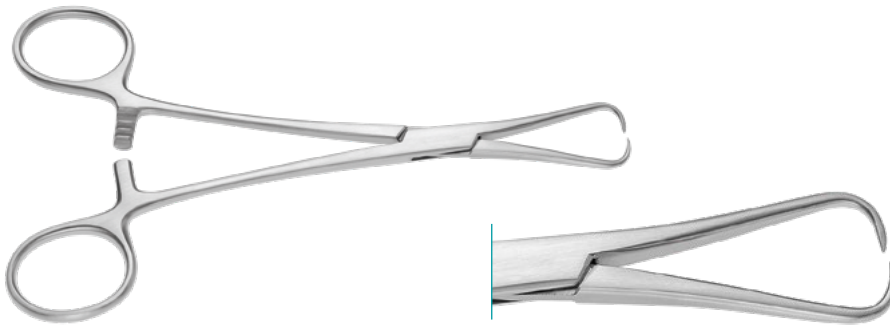

### BERNHARD

Towel Forceps

165mm, 6<sup>1</sup>/<sub>2</sub>"

140-579-165

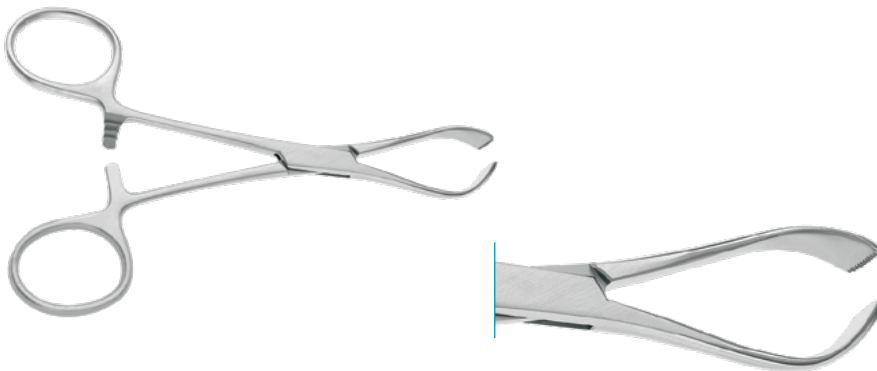

### LORNA

Towel Forceps

100mm, 4"

140-578-100

130mm, 5<sup>1</sup>/<sub>8</sub>"

140-578-130

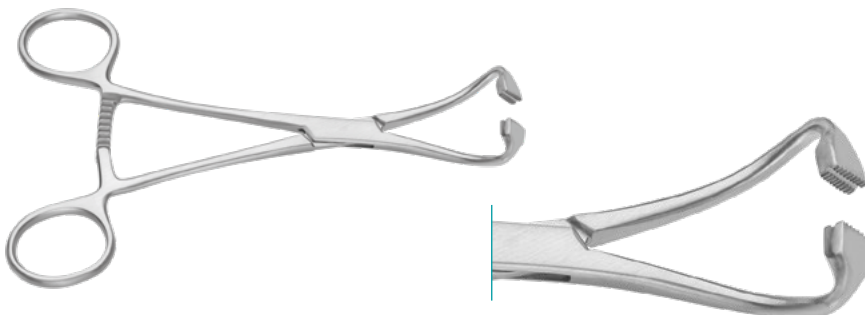

### PEERS

Towel Forceps, non-perforating

145mm, 5<sup>3</sup>/<sub>4</sub>"

140-595-145



### Non-Perforating Towel Forceps

100mm, 4"	140-597-100
135mm, 5 <sup>1</sup> / <sub>3</sub> "	140-597-135



### JONES

#### Towel Clip

60mm, 2 <sup>1</sup> / <sub>3</sub> "	140-561-050
90mm, 3 <sup>1</sup> / <sub>2</sub> "	140-561-090



### TOHOKU

#### Towel Clamp

100mm, 4"	140-590-100
130mm, 5 <sup>1</sup> / <sub>8</sub> "	140-590-130

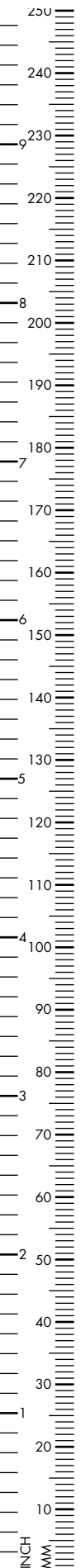

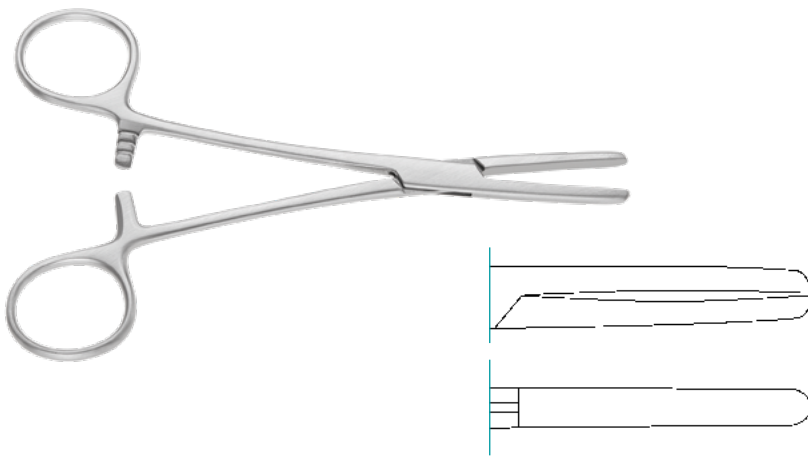

### PRESBYTERIAN HOSPITAL

Tubing Clamp

165mm, 6 <sup>1/2</sup> "	140-601-165
---------------------------	-------------

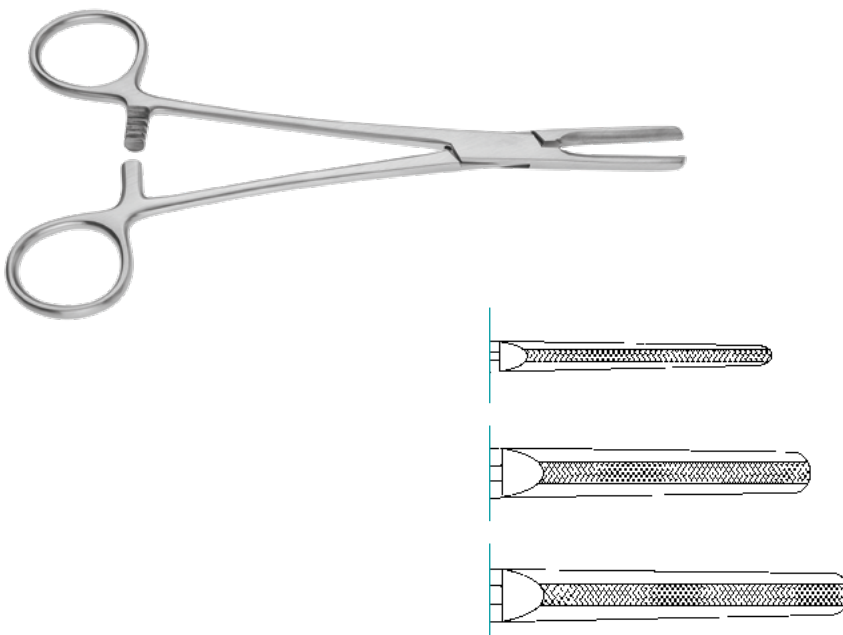

### VORSE

Tubing Clamp, serrated jaws

150mm, 6"	140-603-150
180mm, 7"	140-603-180
200mm, 8"	140-603-200



### VORSE

Tubing Clamp, serrated jaws, with safety guard

150mm, 6"	140-605-150
180mm, 7"	140-605-180
200mm, 8"	140-605-200

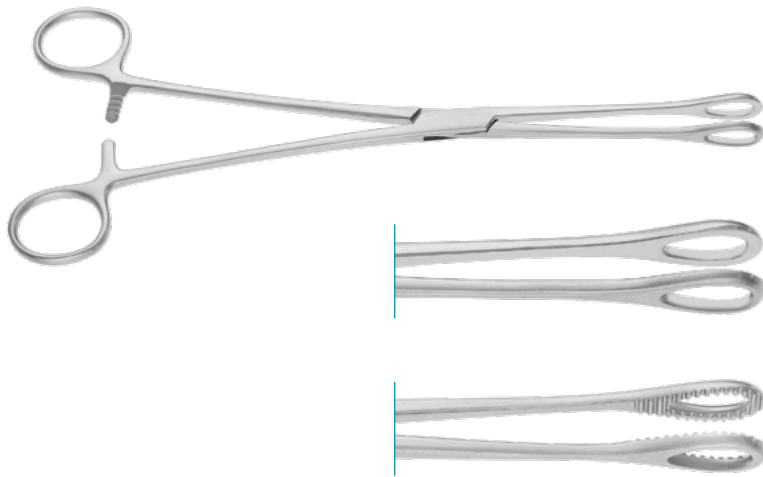

### FOERSTER

Sponge Forceps, smooth, straight

180mm, 7"	150-050-180
200mm, 8"	150-050-200
250mm, 9 <sup>7</sup> / <sub>8</sub> "	150-050-250

smooth, curved

180mm, 7"	150-053-180
200mm, 8"	150-053-200
250mm, 9 <sup>7</sup> / <sub>8</sub> "	150-053-250

serrated, straight

180mm, 7"	150-052-180
200mm, 8"	150-052-200
250mm, 9 <sup>7</sup> / <sub>8</sub> "	150-052-250
355mm, 14"	150-052-355
410mm, 16"	150-052-410

serrated, curved

180mm, 7"	150-055-180
200mm, 8"	150-055-200
250mm, 9 <sup>7</sup> / <sub>8</sub> "	150-055-250

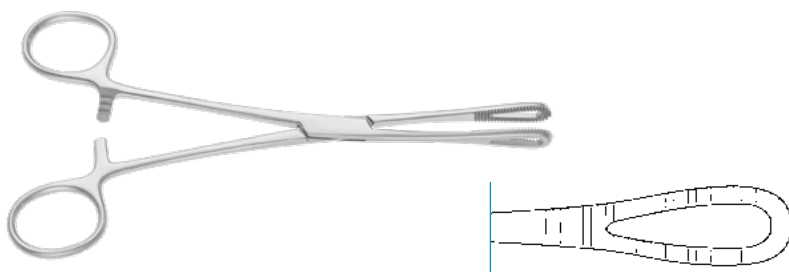

### RAMPLEY

Sponge Forceps, straight, serrated

180mm, 7"	150-070-180
200mm, 8"	150-070-200
250mm, 9 <sup>7</sup> / <sub>8</sub> "	150-070-250

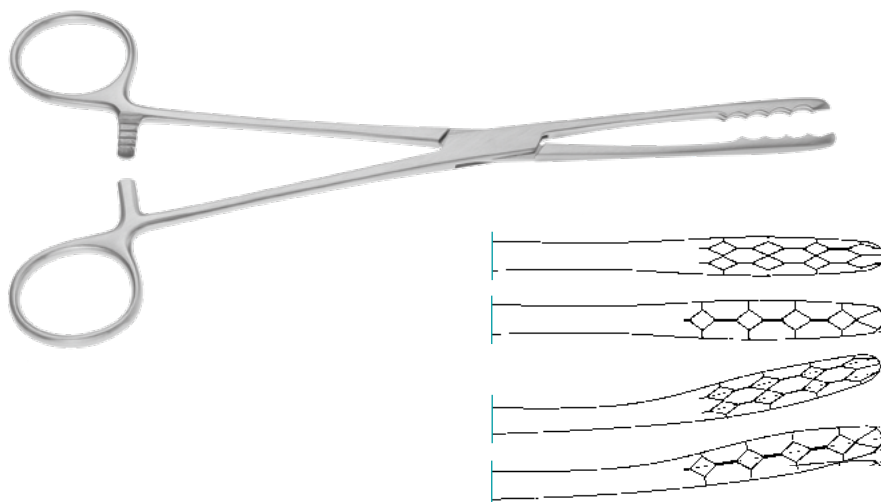

### ULRICH

Swab Forceps, straight

220mm, 8 <sup>2</sup> / <sub>3</sub> "	150-010-220
250mm, 9 <sup>7</sup> / <sub>8</sub> "	150-010-250
270mm, 10 <sup>2</sup> / <sub>3</sub> "	150-010-270

curved

220mm, 8 <sup>2</sup> / <sub>3</sub> "	150-011-220
250mm, 9 <sup>7</sup> / <sub>8</sub> "	150-011-250
270mm, 10 <sup>2</sup> / <sub>3</sub> "	150-011-270

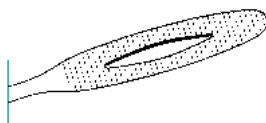
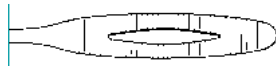
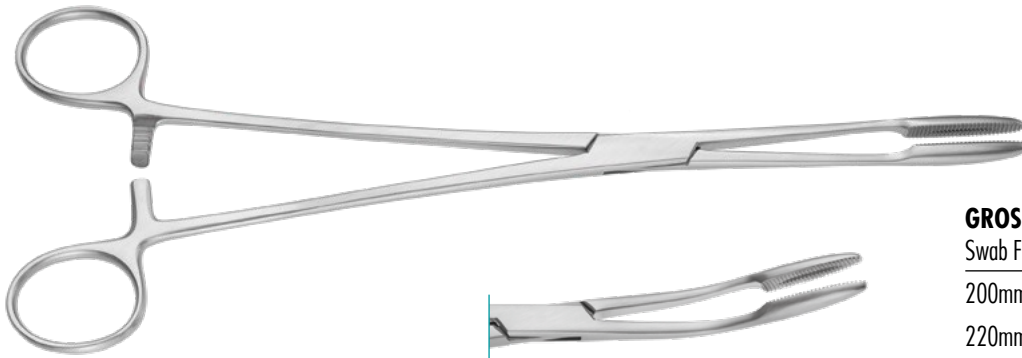

### GROSS MAIER

Swab Forceps, serrated, straight

200mm, 8" 150-030-200

220mm, 8<sup>2</sup>/<sub>3</sub>" 150-030-220

250mm, 9<sup>7</sup>/<sub>8</sub>" 150-030-250

270mm, 10<sup>2</sup>/<sub>3</sub>" 150-030-270

curved

200mm, 8" 150-031-200

220mm, 8<sup>2</sup>/<sub>3</sub>" 150-031-220

250mm, 9<sup>7</sup>/<sub>8</sub>" 150-031-250

270mm, 10<sup>2</sup>/<sub>3</sub>" 150-031-270

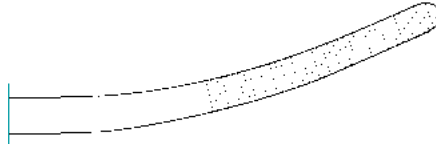
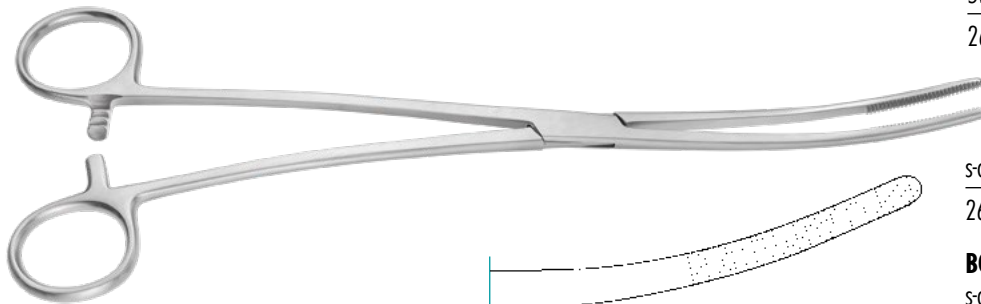

### BOZEMANN

Swab Forceps, serrated, straight

260mm, 10<sup>1</sup>/<sub>4</sub>" 150-040-260

s-curved

260mm, 10<sup>1</sup>/<sub>4</sub>" 150-041-260

### BOZEMANN DOUGLAS

s-curved, one large ring

260mm, 10<sup>1</sup>/<sub>4</sub>" 150-043-260

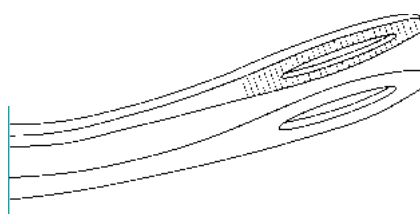
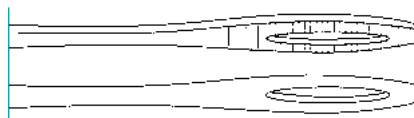
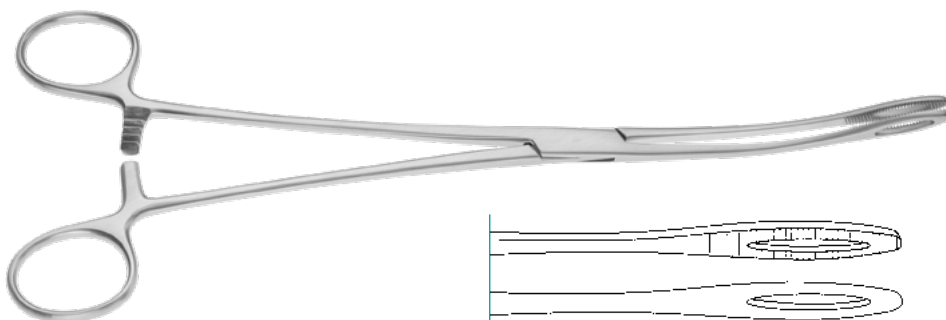

### FOERSTER BONNEY

Swab Forceps, serrated, narrow, straight

250mm, 9<sup>7</sup>/<sub>8</sub>" 150-060-250

curved

250mm, 9<sup>7</sup>/<sub>8</sub>" 150-061-250

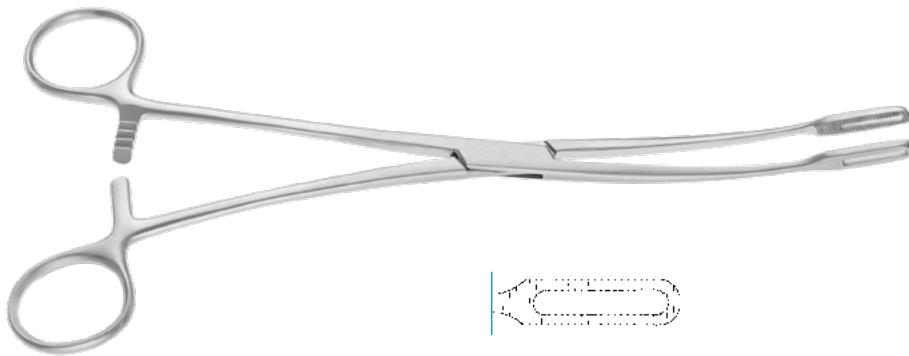

### FLETCHER

Sponge Forceps, 240mm, 9<sup>1</sup>/<sub>2</sub>"

straight	150-046-240
s-curved	150-047-240



### LISTER

Dressing Forceps

130mm, 5 <sup>1</sup> / <sub>8</sub> "	150-080-130
160mm, 6 <sup>1</sup> / <sub>4</sub> "	150-080-160
180mm, 7"	150-080-180



### BRYANT

Dressing Forceps

130mm, 5 <sup>1</sup> / <sub>8</sub> "	150-035-130
--	-------------

