

NEEDLE HOLDERS



Needle Holders
TC Needle Holders
Ligature Needles
Michel Clips

Needle Holders *without* Tungsten Carbide inserts



Standard serration for an optimal grip of the needle.

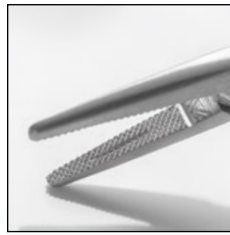

Standard serration with additional groove



Standard Ring Handle

Needle Holders *with* Tungsten Carbide inserts



Normal serration of 0.5 for use with sutures up to size 4-0



Fine serration of 0.4 for use with sutures up to size 5-0 / 6-0



Mirror gold finished ring handle



Extra fine serration of 0.3 for use with sutures up to size 10-0



Smooth serration for use with sutures up to size 7-0 to 10-0

Needle Holders with Diamond Dusted jaw



Diamond dusted coating of the jaw hardens the working surface, improves the durability and guarantees a tight grip of fine needles



Mirror finished ring handle

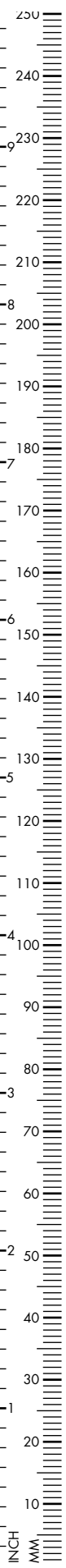



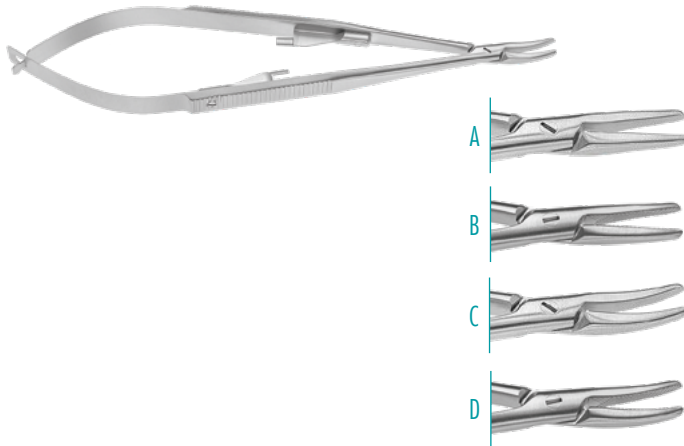
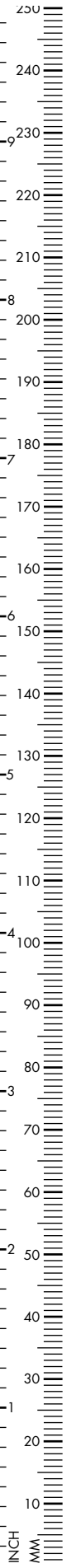

CASTROVIEJO

Micro Needle Holder, with catch, flat handle

A straight, smooth

145mm, 5³/₄" 180-219-145

180mm, 7" 180-219-180

B straight, serrated

145mm, 5³/₄" 180-220-145

180mm, 7" 180-220-180

C curved, smooth

145mm, 5³/₄" 180-221-145

180mm, 7" 180-221-180

D curved, serrated

145mm, 5³/₄" 180-222-145

180mm, 7" 180-222-180



Vascular Micro Needle Holder, 0.4mm tip,
flat handle, 140mm, 5¹/₂"
straight, smooth

with catch 250-064-153

without catch 250-064-149

curved, smooth

with catch 250-064-151

without catch 250-064-150



Vascular Micro Needle Holder, 0.4mm tip,
straight, smooth, round handle, without catch

130mm, 5¹/₈" 250-064-138

180mm, 7" 250-064-244

curved

130mm, 5¹/₈" 250-064-142

180mm, 7" 250-064-248



BARRAQUER

Micro Needle Holder, curved, smooth,

0.5mm tip, without lock,

Ø 8mm round handle

110mm, 4¹/₃" 400-345-110

130mm, 5¹/₈" 400-348-135

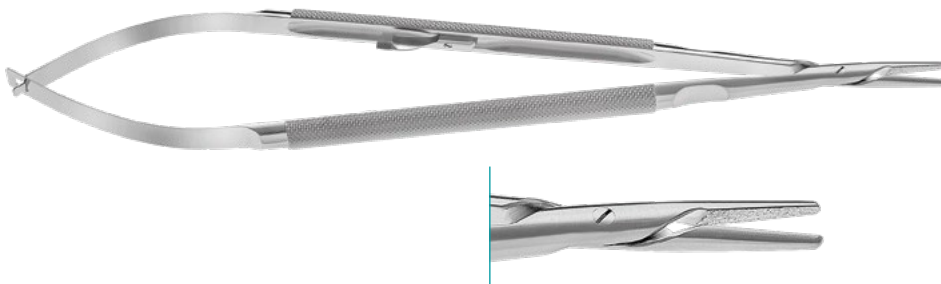

JACOBSON

Needle Holder, streamline, heavy pattern, 2mm jaw, 10mm round handle, with catch, straight

190mm, 7^{1/2}" 250-018-190

230mm, 9" 250-018-230

250mm, 9^{7/8}" 250-018-250

curved

230mm, 9" 250-019-230



CASTROVIEJO

Micro Needle Holder, with catch, 1mm jaw, flat handle, 140mm, 5^{1/2}"

straight 250-220-563

curved 250-220-564



LÖFFLER

Needle Holder, delicate, short jaw ring handle, straight

150mm, 6" 180-755-150

180mm, 7" 180-755-180

200mm, 8" 180-755-200

230mm, 9" 180-755-230

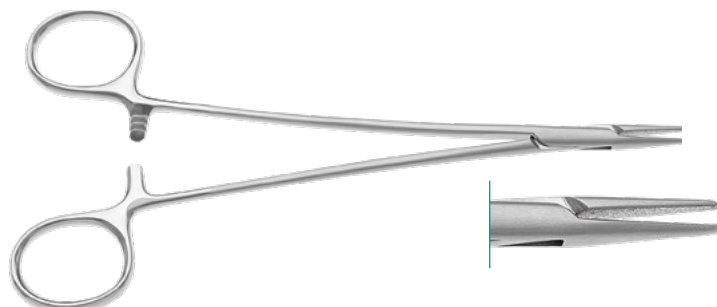

DEBAKEY

Needle Holder, ring handle, 1mm jaw, straight

180mm, 7" 180-648-180

200mm, 8" 180-648-200

230mm, 9" 180-648-230



YANG

Very delicate, straight, smooth

110mm, 4¹/₃"

180-318-110



YANG

Very delicate, straight

110mm, 4¹/₃"

180-320-110



WEBSTER

Straight, smooth

130mm, 5¹/₈"

180-318-130

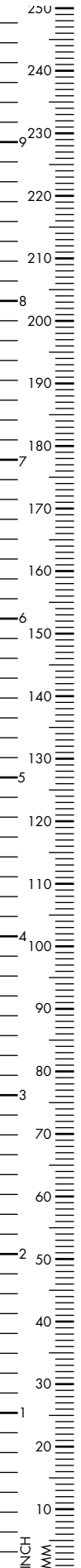

**NEIVERT**

Off-set ring, smooth, straight

130mm, 5^{1/8}"

180-322-130

**CONVERSE**

Longitudinal serrated jaw, straight

125mm, 5"

180-310-125

**DERF**

Grooved serrated jaw, straight

120mm, 4^{3/4}"

180-310-120

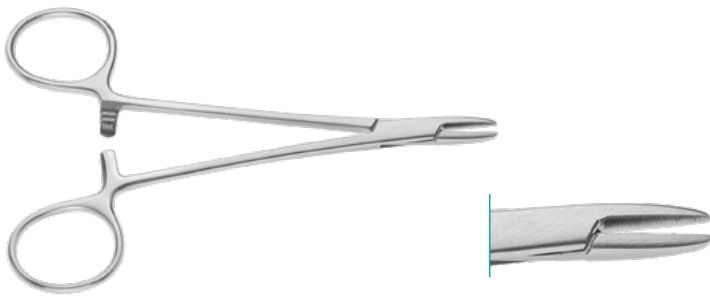
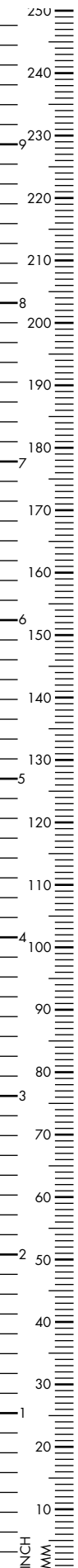

BROWN

Serrated, rounded jaw, straight

130mm, 5^{1/8}"

180-326-130

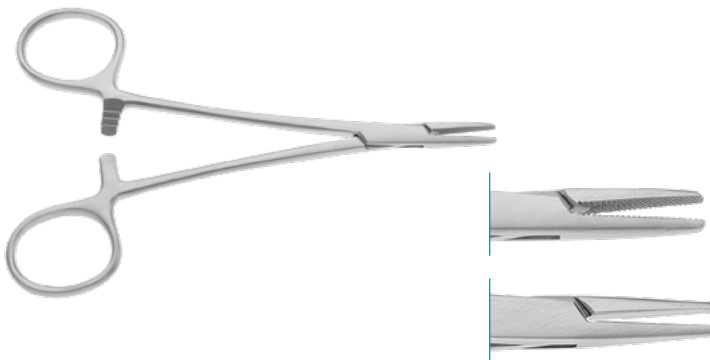

HALSEY

Cross serrated jaw, straight

130mm, 5^{1/8}"

180-321-130

Smooth

130mm, 5^{1/8}"

180-320-130

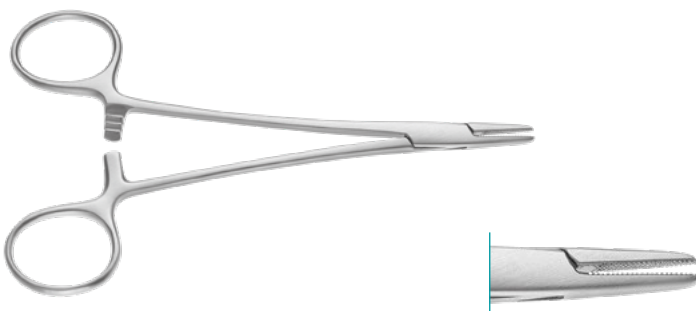

BAUMGARTNER

Serrated jaw, straight

125mm, 5"

180-324-125

140mm, 5^{1/2}"

180-324-140

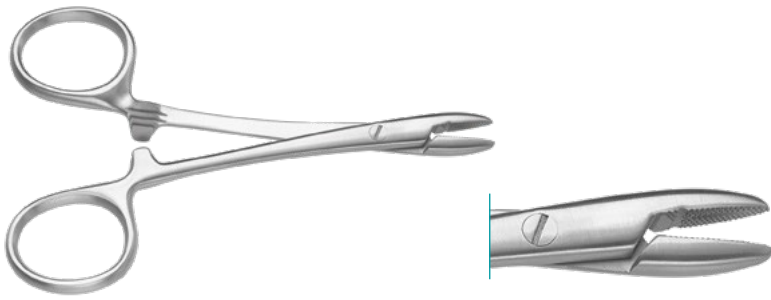

DOYEN

Serrated jaw, straight

130mm, 5¹/₈"

180-317-130



COLLIER

Cross serrated jaw, fenestrated, straight

125mm, 5"

180-314-125

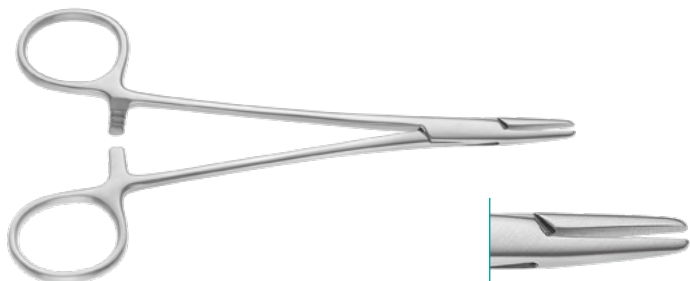

LAWRENCE

Smooth, delicate jaw, straight

150mm, 6"

180-381-150

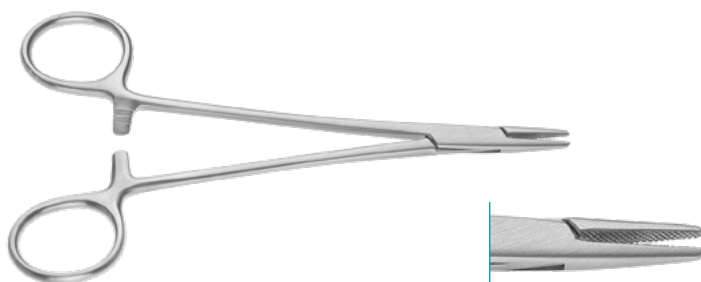

CRILE MURRAY

Serrated jaw, straight

150mm, 6"

180-330-150

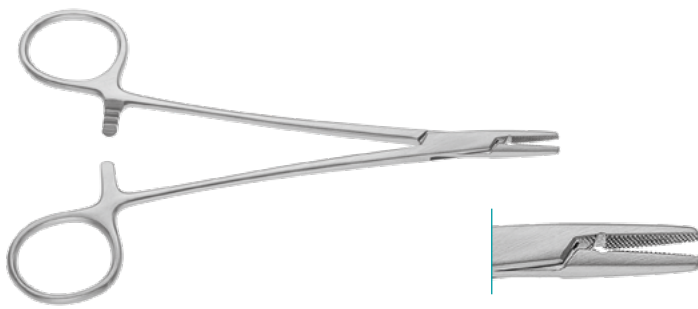

CRILE WOOD

Serrated jaw, straight

150mm, 6"	180-332-150
180mm, 7"	180-332-180
200mm, 8"	180-332-200

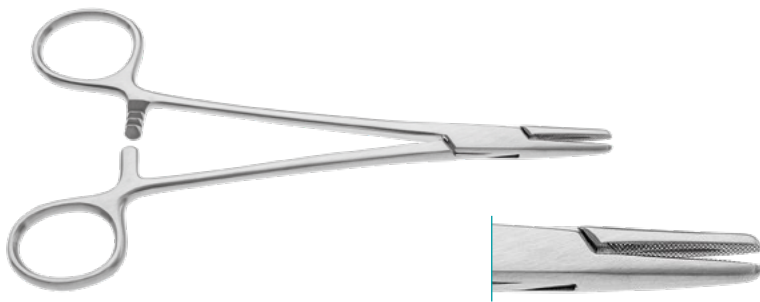

MAYO HEGAR

Grooved serrated jaw, straight

140mm, 5 ¹ / ₂ "	180-354-140
160mm, 6 ¹ / ₄ "	180-354-160
180mm, 7"	180-354-180
200mm, 8"	180-354-200
240mm, 9 ¹ / ₂ "	180-354-240
260mm, 10 ¹ / ₄ "	180-354-260
300mm, 11 ⁷ / ₈ "	180-354-300

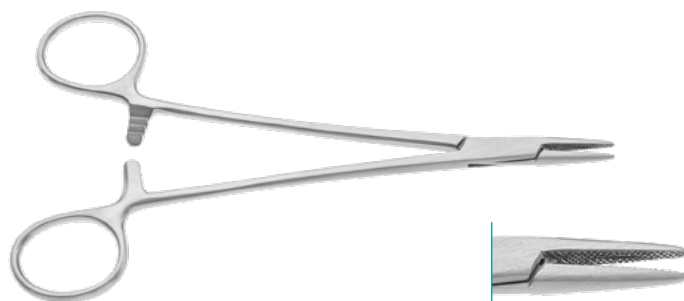

MAYO HEGAR FINO

Delicate Pattern, serrated, straight

140mm, 5 ¹ / ₂ "	180-356-140
160mm, 6 ¹ / ₄ "	180-356-160
180mm, 7"	180-356-180
200mm, 8"	180-356-200

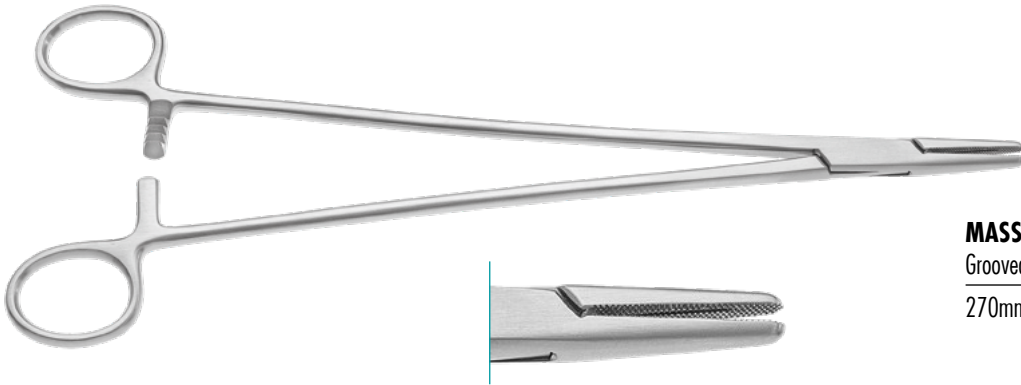

MASSON

Grooved, serrated jaw, straight

270mm, 10²/₃"

180-364-270

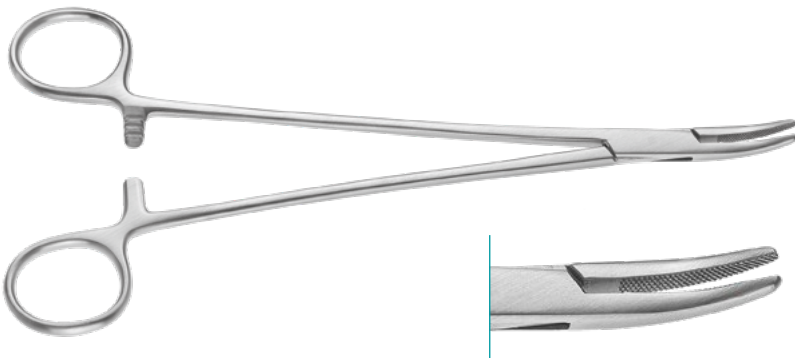

HEANEY

Serrated jaw, curved

210mm, 8¹/₄"

180-361-210

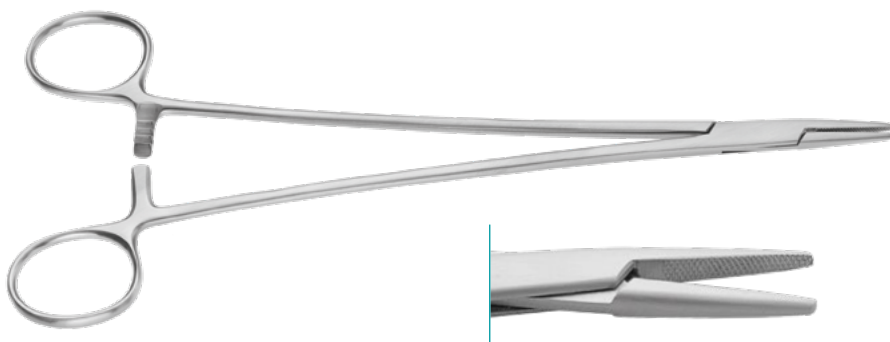

JAMISON

Serrated jaw, straight

235mm, 9¹/₄"

180-362-235

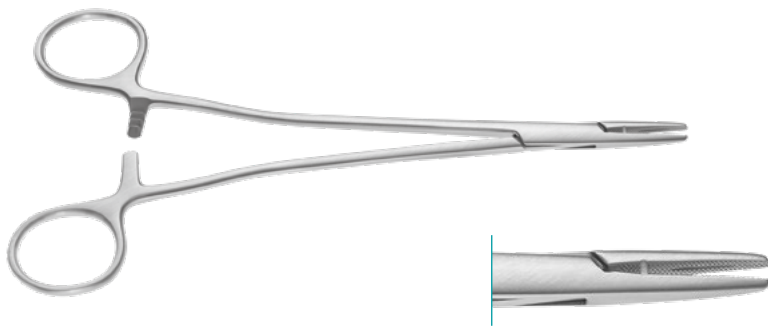

SAROT

Grooved serrated jaw, straight

180mm, 7"	180-342-180
-----------	-------------



OLSEN HEGAR

Serrated jaw, straight

140mm, 5 ¹ / ₂ "	180-382-140
--	-------------

170mm, 6 ² / ₃ "	180-382-170
--	-------------

180mm, 7"	180-382-180
-----------	-------------

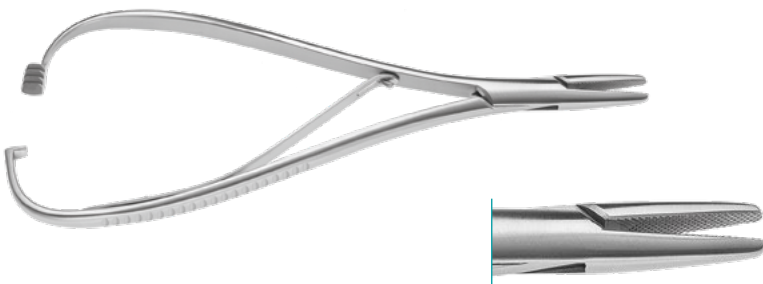

MATHIEU

Serrated jaw, straight

140mm, 5 ¹ / ₂ "	180-420-140
--	-------------

170mm, 6 ² / ₃ "	180-420-170
--	-------------

200mm, 8"	180-420-200
-----------	-------------

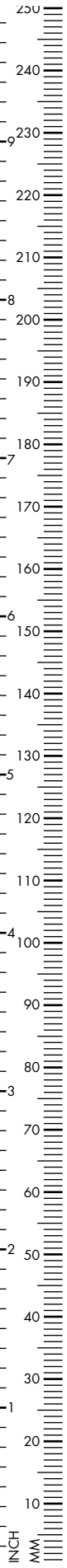

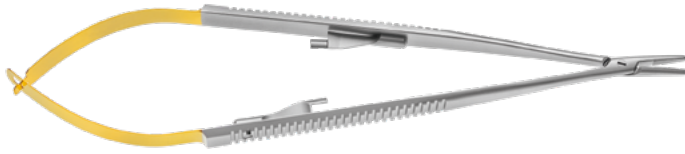

CASTROVIEJO

Micro Needle Holder, serrated jaw, flat handle, with catch

145mm, 5 ³ / ₄ "	180-520-145
180mm, 7"	180-520-180
210mm, 8 ¹ / ₄ "	180-520-210

without catch

145mm, 5 ³ / ₄ "	180-524-140
180mm, 7"	180-524-180
210mm, 8 ¹ / ₄ "	180-524-210

smooth jaw, with catch

145mm, 5 ³ / ₄ "	180-519-145
180mm, 7"	180-519-180
210mm, 8 ¹ / ₄ "	180-519-210

without catch

145mm, 5 ³ / ₄ "	180-522-145
180mm, 7"	180-522-180
210mm, 8 ¹ / ₄ "	180-522-210



CASTROVIEJO

Smooth jaw, curved, without catch

145mm, 5 ³ / ₄ "	180-526-145
180mm, 7"	180-526-180
210mm, 8 ¹ / ₄ "	180-526-210

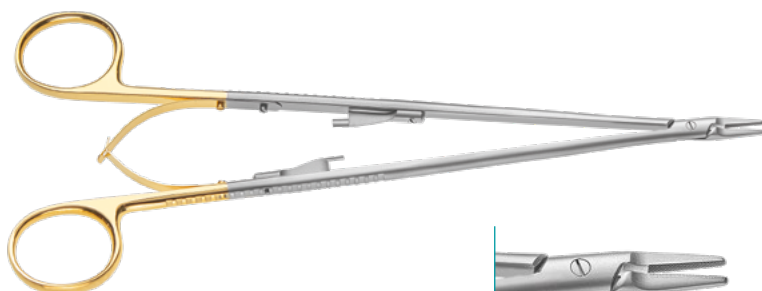

DIETRICH RYDER

Microvascular, bead blusted, 2mm jaw, straight, serrated

180mm, 7"	180-530-180
200mm, 8"	180-530-200
230mm, 9"	180-530-230
260mm, 10 ¹ / ₄ "	180-530-260

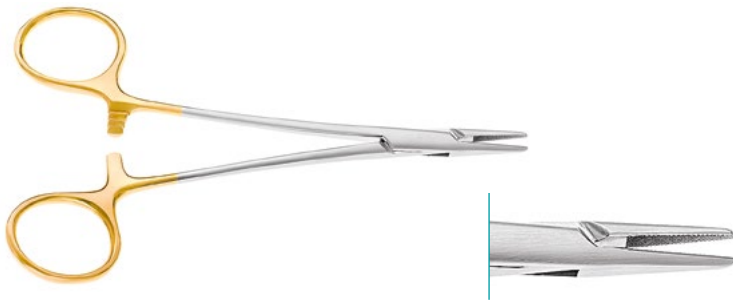

NEIVERT

Fine serrated jaw, upturned thumb ring

130mm, 5^{1/8}"

180-533-130

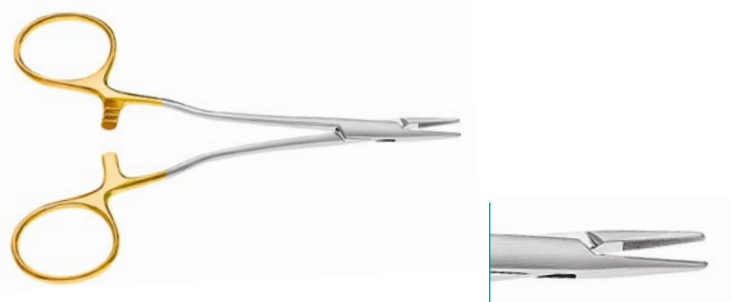

CONVERSE

Cross-serrated jaw, straight

120mm, 4^{3/4}"

180-544-120

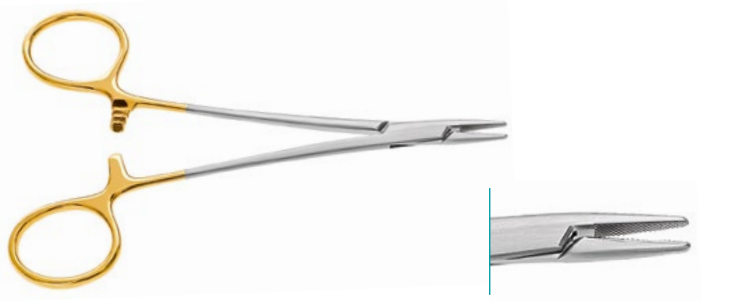

DERF

Serrated jaw, straight

120mm, 4^{3/4}"

180-532-120

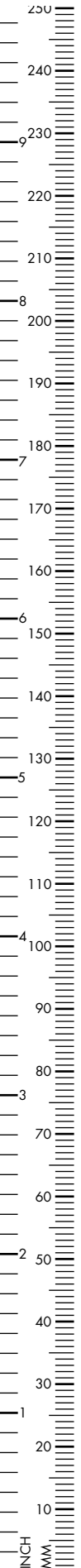

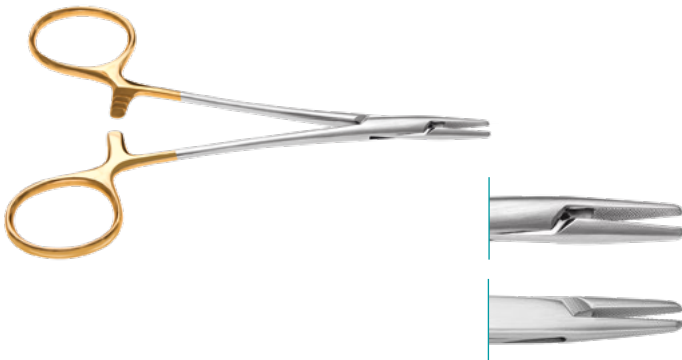

PAR

Serrated, very delicate jaw, straight

115mm, 4¹/₂" 180-555-115

delicate, serrated jaw

120mm, 4³/₄" 180-558-120

135mm, 5¹/₃" 180-558-135

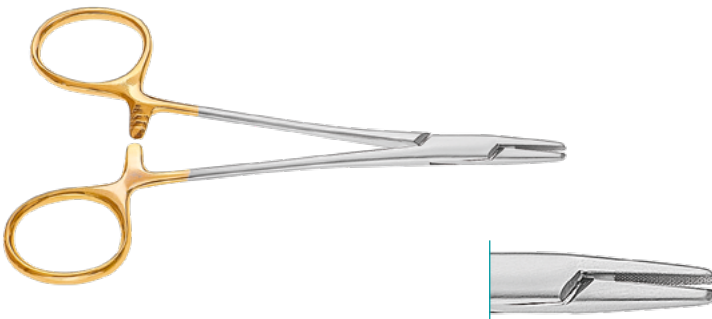

HEGAR BAUMGARTNER

Serrated jaw, straight

125mm, 5" 180-534-125

140mm, 5¹/₂" 180-534-140



YANG

Smooth jaw, delicate pattern, straight

115mm, 4¹/₂" 180-536-115

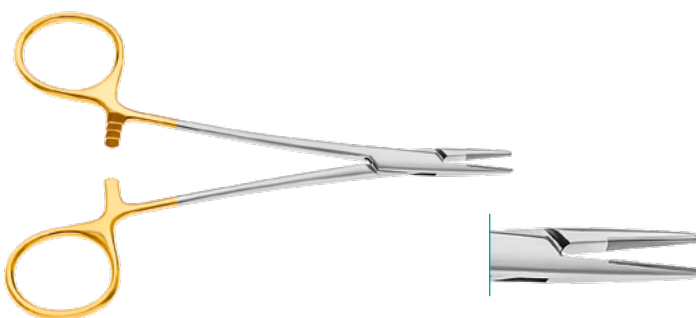

WEBSTER

Smooth jaw, delicate pattern, straight

130mm, 5¹/₈" 180-538-130

serrated jaw

130mm, 5¹/₈" 180-539-130



HALSEY

Serrated jaw, straight

130mm, 5^{1/8}" 180-537-130

smooth jaw

130mm, 5^{1/8}" 180-536-130



BABY CRILE WOOD

Serrated jaw, straight

150mm, 6" 180-542-150

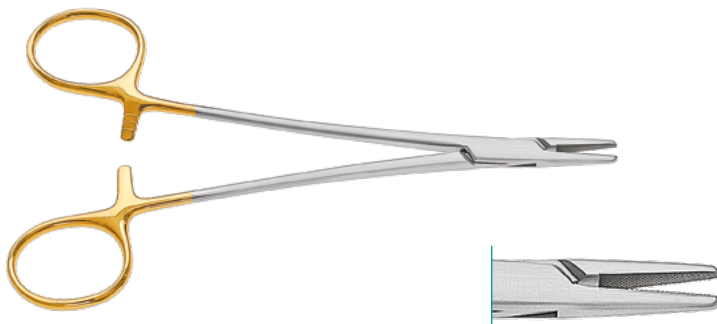

CRILE WOOD

Serrated jaw, straight

150mm, 6" 180-540-150

180mm, 7" 180-540-180

200mm, 8" 180-540-200

230mm, 9" 180-540-230

260mm, 10^{1/4}" 180-540-260

300mm, 11^{7/8}" 180-540-300

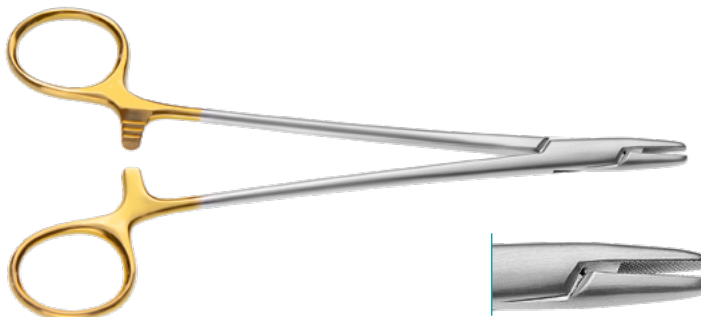

NEW ORLEANS

Grooved, serrated jaw, straight

180mm, 7" 180-553-180

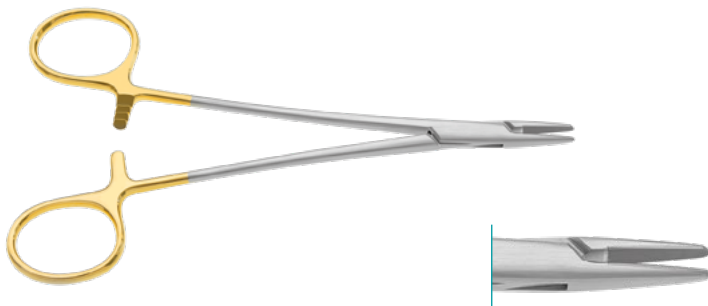

CRILE WOOD

Smooth jaw, straight

150mm, 6"	180-541-150
180mm, 7"	180-541-180
200mm, 8"	180-541-200
230mm, 9"	180-541-230

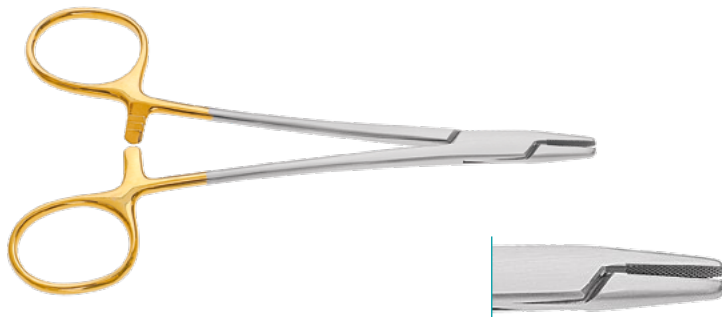

MAYO HEGAR

Serrated jaw, straight

125mm, 5"	180-550-125
140mm, 5 ¹ / ₂ "	180-550-140
160mm, 6 ¹ / ₄ "	180-550-160
180mm, 7"	180-550-180
200mm, 8"	180-550-200
240mm, 9 ¹ / ₂ "	180-550-240
260mm, 10 ¹ / ₄ "	180-550-260
300mm, 11 ⁷ / ₈ "	180-550-300
355mm, 14"	180-550-355
400mm, 15 ³ / ₄ "	180-550-400

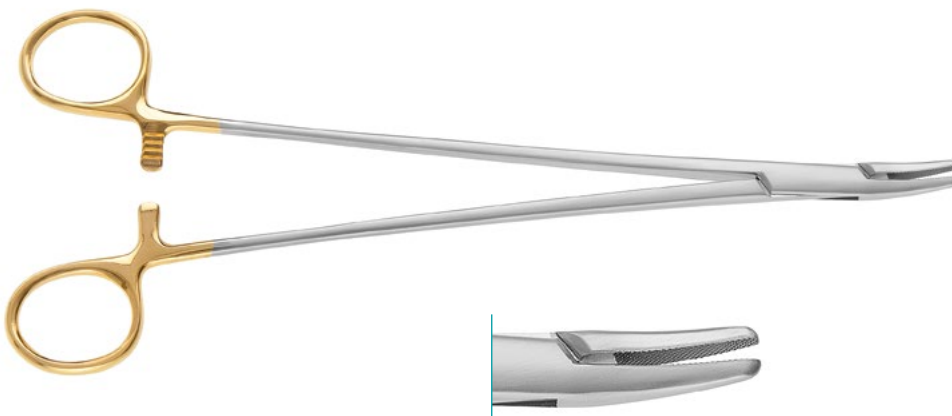

HEANEY

Serrated jaw, curved

200mm, 8"	180-547-200
240mm, 9 ¹ / ₂ "	180-547-240
260mm, 10 ¹ / ₄ "	180-547-260
305mm, 12"	180-547-305
410mm, 16 ¹ / ₄ "	180-547-410

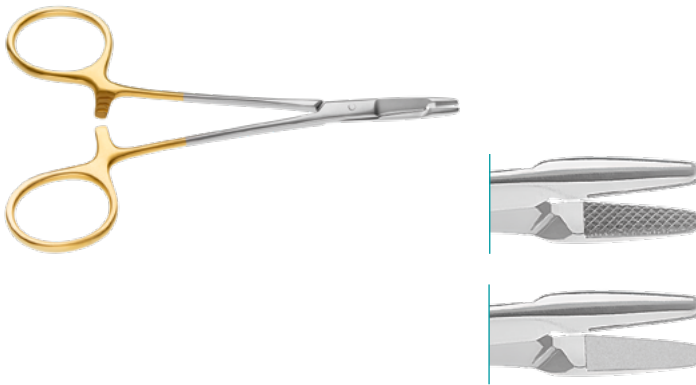
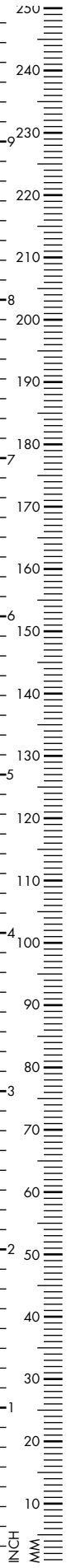

MINI OLSEN HEGAR

Serrated jaw, straight

120mm, 4^{3/4}" 180-568-120

smooth jaw

120mm, 4^{3/2}" 180-569-120



OLSEN HEGAR

Serrated jaw, straight

140mm, 5^{1/2}" 180-568-140

170mm, 6^{2/3}" 180-568-170

180mm, 7" 180-568-180

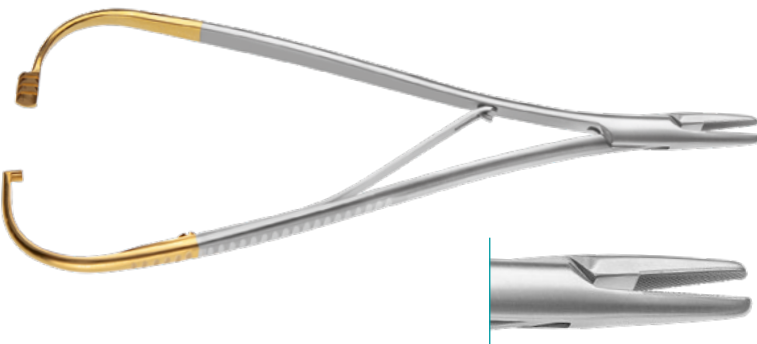

MATHIEU

Serrated jaw, straight

140mm, 5^{1/2}" 180-576-140

170mm, 6^{2/3}" 180-576-170

200mm, 8" 180-576-200



GILLIES

Upturned thumb ring, serrated jaw, curved

160mm, 5^{1/4}" 180-570-160

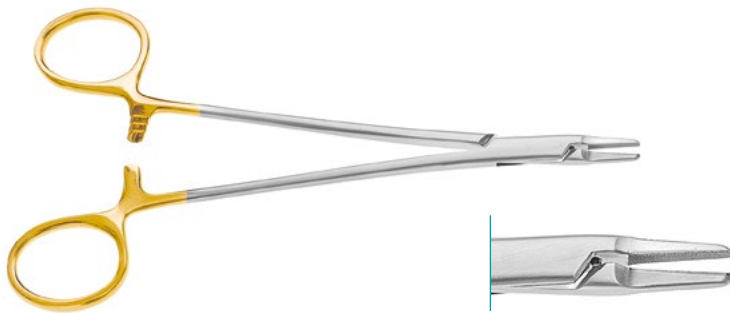

RYDER

2.0mm tip, serrated jaw, straight

130mm, 5 ¹ / ₈ "	180-560-130
160mm, 6 ¹ / ₄ "	180-560-160
180mm, 7"	180-560-180
200mm, 8"	180-560-200
230mm, 9"	180-560-230
260mm, 10 ¹ / ₄ "	180-560-260

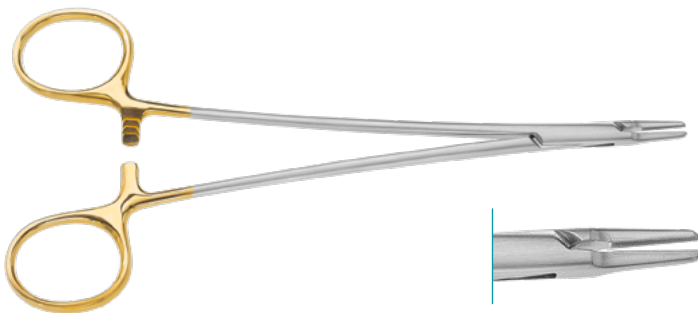

RYDER

1.5mm vascular tip, serrated jaw, straight

130mm, 5 ¹ / ₈ "	180-561-130
160mm, 6 ¹ / ₄ "	180-561-150
180mm, 7"	180-561-180
200mm, 8"	180-561-200
230mm, 9"	180-561-230

1.0mm smooth jaw

140mm, 5 ¹ / ₂ "	180-565-140
160mm, 6 ¹ / ₄ "	180-565-160

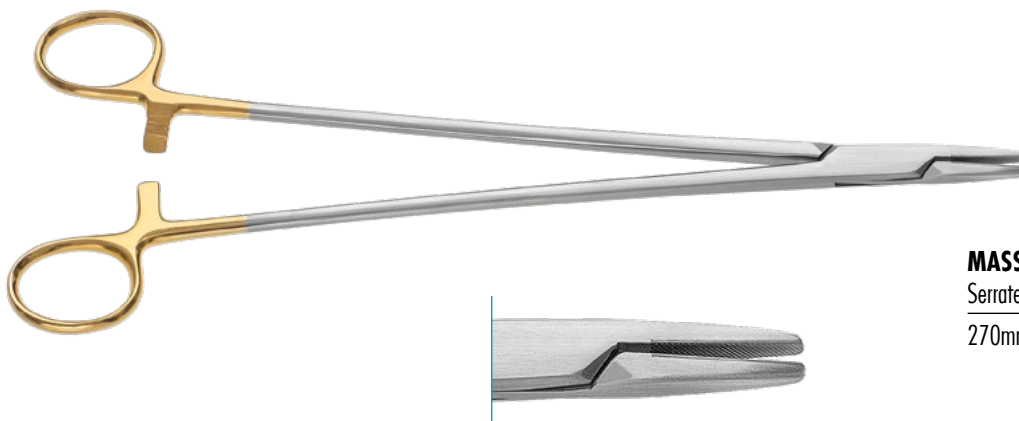

MASSON

Serrated, heavy pattern, straight

270mm, 10 ² / ₃ "	180-556-270
---	-------------

NEEDLE HOLDERS

TC Needle Holders

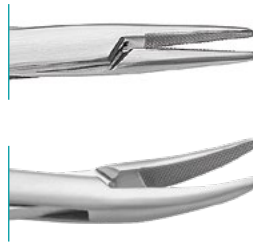
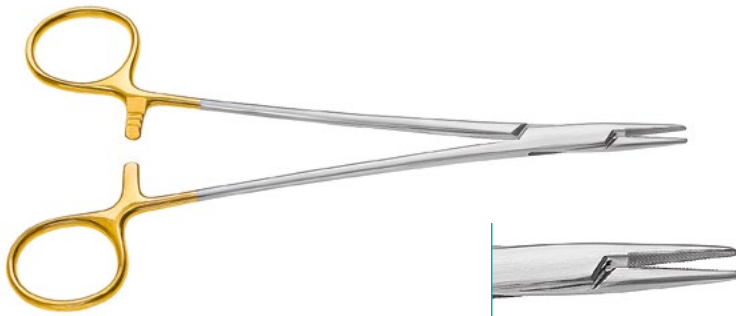
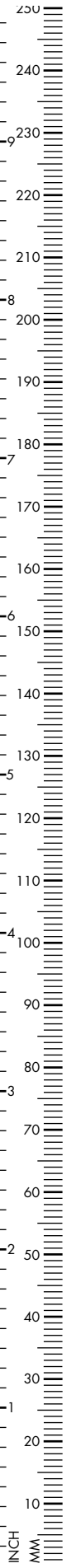

DEBAKEY

Vascular, serrated, straight

150mm, 6"	180-548-150
180mm, 7"	180-548-180
200mm, 8"	180-548-200
230mm, 9"	180-548-230
260mm, 10 ¹ / ₄ "	180-548-260
310mm, 12 ¹ / ₄ "	180-548-310
370mm, 14 ¹ / ₂ "	180-548-370

curved

150mm, 6"	180-549-150
180mm, 7"	180-549-180
200mm, 8"	180-549-200
230mm, 9"	180-549-230
260mm, 10 ¹ / ₄ "	180-549-260

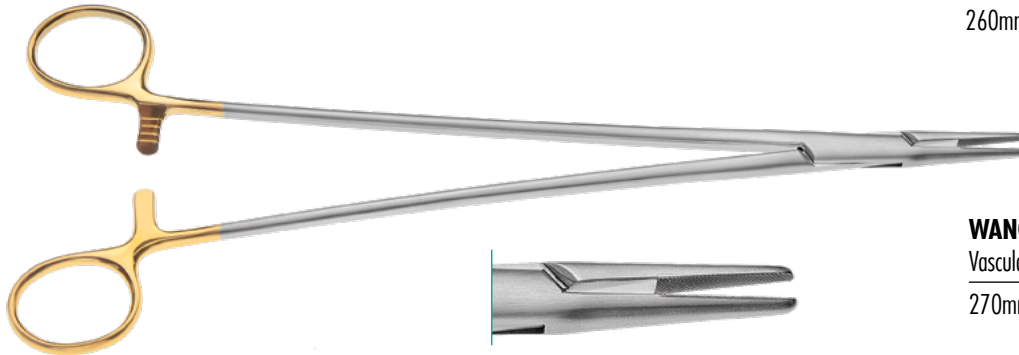

WANGENSTEEN

Vascular, serrated jaw, straight

270mm, 10 ² / ₃ "	180-562-270
---	-------------

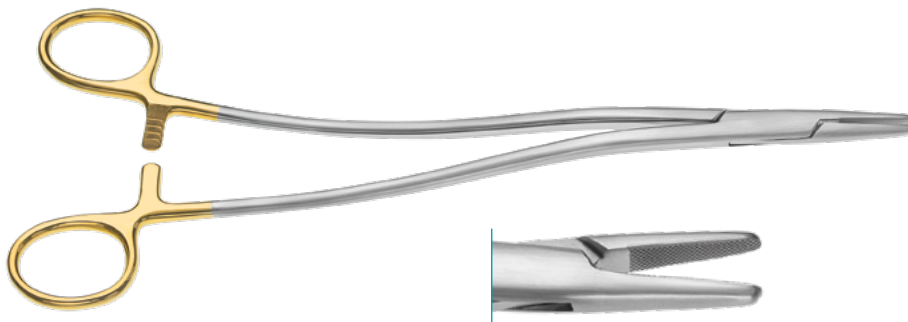

WERTHEIM

S-curved, serrated, straight jaw

200mm, 8"	180-574-200
240mm, 9 ¹ / ₂ "	180-574-240
300mm, 11 ⁷ / ₈ "	180-574-300

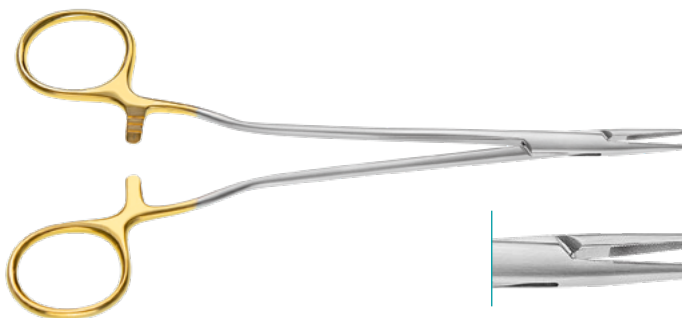

HEGAR

Vascular, micro profile, straight

140mm, 5 ¹ / ₂ "	180-590-140
180mm, 7"	180-590-180
200mm, 8"	180-590-200
230mm, 9"	180-590-230



FINOCHIETTO

Serrated, angled jaw

200mm, 8"	180-558-200
270mm, 10 ² / ₃ "	180-558-270

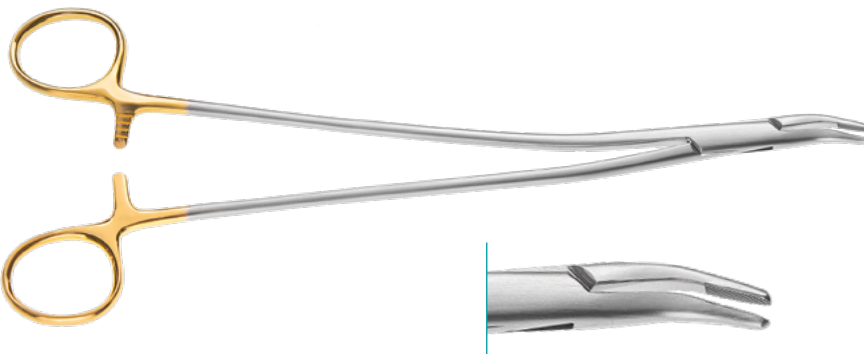

STRATTE

Laterally s-curved, serrated

200mm, 8"	180-567-200
230mm, 9"	180-567-230

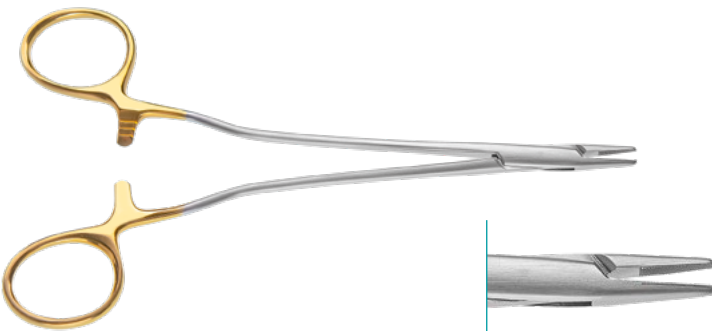

SWEDISH PATTERN

Straight, serrated jaw

150mm, 6"	180-555-150
170mm, 6 ² / ₃ "	180-555-170
200mm, 8"	180-555-200
250mm, 9 ⁷ / ₈ "	180-555-250

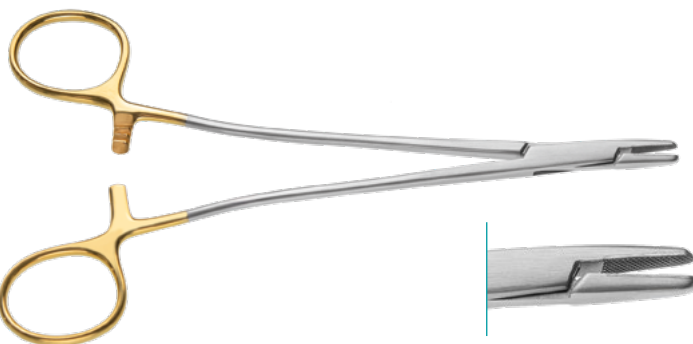

SAROT

Serrated jaw, straight

180mm, 7"	180-545-180
200mm, 8"	180-545-200
260mm, 10 ¹ / ₄ "	180-545-260

NEEDLE HOLDERS

Wire TC Needle Holders

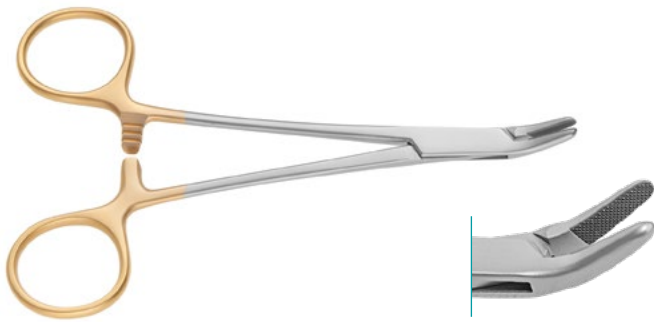

Wire Twister, serrated, curved jaws

150mm, 6"

180-501-150



CORWIN

Wire Tightener, straight

150mm, 6"

180-810-150

185mm, 7^{1/4}"

180-810-185



BERRY

Wire Tightener, straight

180mm, 7"

180-309-180

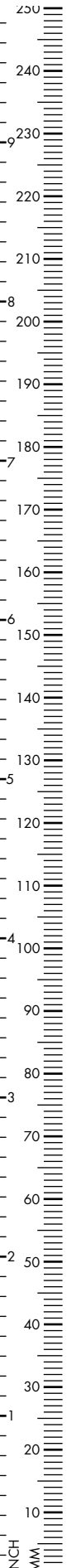

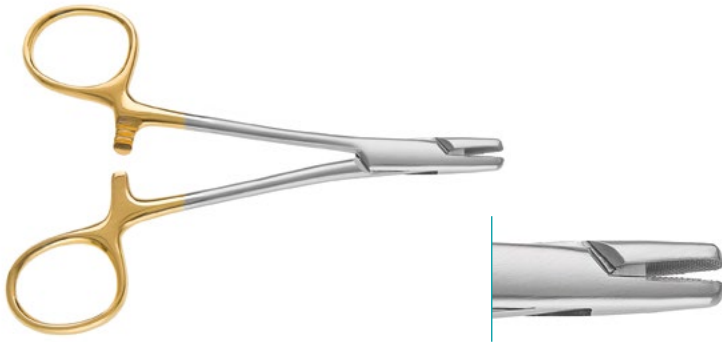

TC Wire Holding Forceps, rounded jaw, straight
130mm, 5¹/₈" 180-569-130

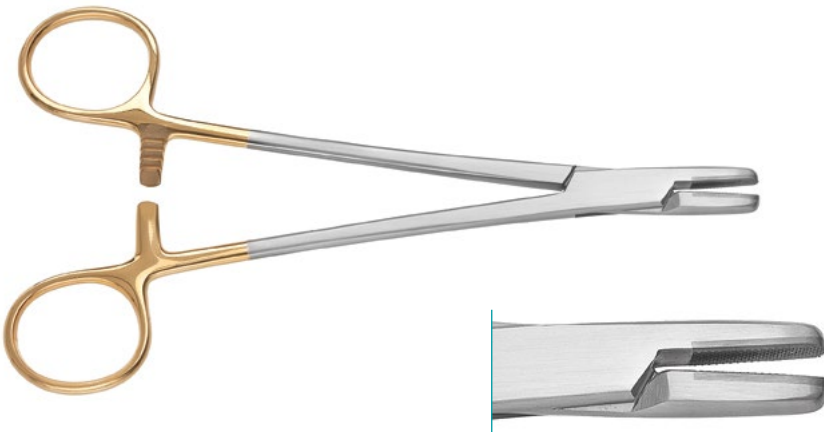

BERRY
TC Heavy Sternal Forceps, square jaw, straight
150mm, 6" 180-307-150
180mm, 7" 180-307-180
200mm, 8" 180-307-200
rounded jaw
150mm, 6" 180-308-150
180mm, 7" 180-307-180
200mm, 8" 180-308-200

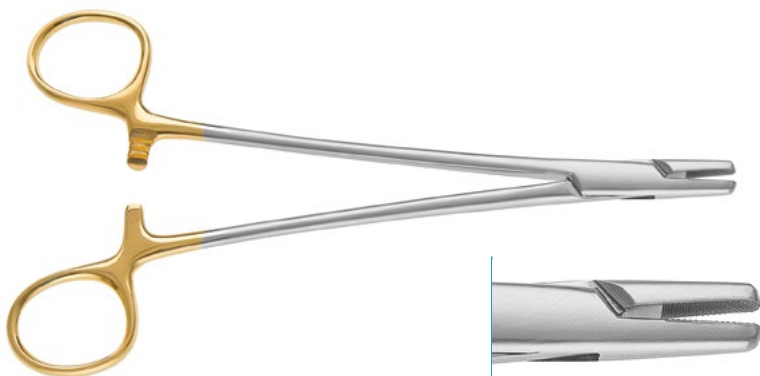

Sternum Wire Holding Forceps, rounded jaw
180mm, 7" 180-569-180

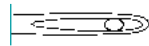
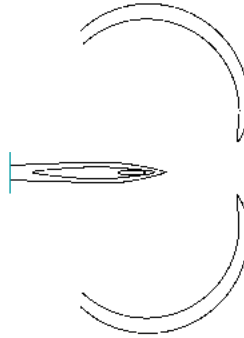

DESCHAMPS

Ligature Needles, sharp

left curved, for right hand 180-724-200

right curved, for left hand 180-728-200

blunt

left curved, for right hand 180-726-210

right curved, for left hand 180-727-210

COOPER

Ligature Needle

190mm, 7¹/₂" 180-732-190

200mm, 8" 180-732-200

HURD

Ligature Needle, 210mm, 8¹/₄"

right 180-719-210

left 180-718-210



HEGENBARTH

Clip Applying Forceps

125mm, 5"

180-920-125



WACHENFELDT

Clip Applying Forceps

125mm, 5"

180-922-125



MICHEL

Clip Applying & Removal Forceps

120mm, 4³/₄"

180-916-120

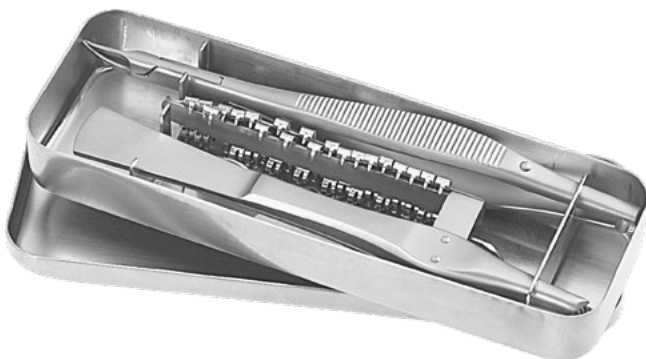

MICHEL

Clip Set, complete in metal case

180-950-000



MICHEL

Clip Removal Forceps

120mm, 4^{3/4}"

180-920-120

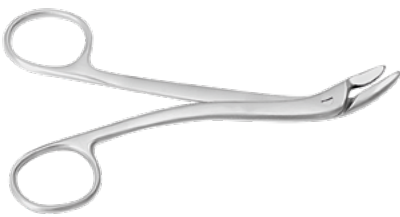

RICHTER-HEATH

Clip Removal Forceps

140mm, 5^{1/2}"

180-936-140



MICHEL

Suture Clips, package of 100 pcs.

7.5mm x 1.75mm	180-940-075
11.0mm x 2.0mm	180-940-110
12.0mm x 3.0mm	180-940-120
14.0mm x 3.0mm	180-940-140
16.0mm x 3.0mm	180-940-160
18.0mm x 3.0mm	180-940-180
20.0mm x 3.0mm	180-940-200
22.0mm x 3.0mm	180-940-220

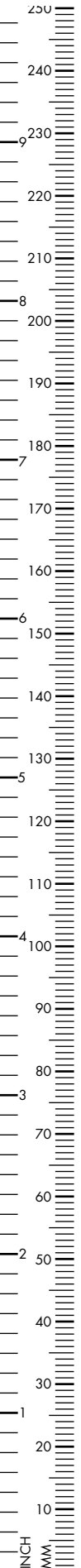

NEEDLE HOLDERS

