

MICROSURGICAL INSTRUMENTS

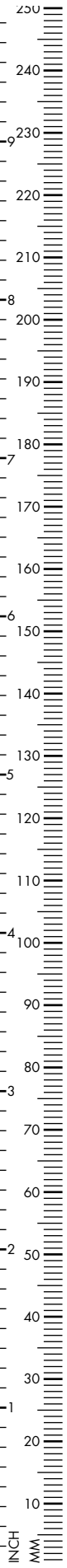

Titanium Forceps
Micro Forceps
Titanium Needle Holder
Micro Needle Holder
Micro Scissors



Titanium Micro Suture Tying Forceps
6mm platform, 8mm round handle
straight

120mm, 4 ³ / ₄ "	250-364-280
150mm, 6"	250-364-284



Titanium Micro Ring Tip Forceps
8mm round handle with counter balance
1mm ring tip

150mm, 6"	250-764-715
180mm, 7"	250-764-718
210mm, 8 ¹ / ₄ "	250-764-721
230mm, 9"	250-764-723
254mm, 10"	250-764-725



Titanium Micro Ring Tip Forceps
8mm round handle
1mm ring tip

150mm, 6"	250-364-705
180mm, 7"	250-364-704
2mm ring tip	
150mm, 6"	250-364-703
180mm, 7"	250-364-706
210mm, 8 ¹ / ₄ "	250-364-707



Titanium Micro Forceps
6mm platform, 8mm round handle
straight

180mm, 7" 250-364-286

210mm, 8¹/₄" 250-364-276

230mm, 9" 250-364-270

curved

180mm, 7" 250-364-287

210mm, 8¹/₄" 250-364-277

230mm, 9" 250-364-271



Titanium Micro Forceps
6mm platform, 8mm round handle
with counter balance, 0.8mm jaw, straight

180mm, 7" 250-364-250

210mm, 8¹/₄" 250-364-252

curved

180mm, 7" 250-364-251

210mm, 8¹/₄" 250-364-253



Titanium DeBakey Micro Forceps
1.2mm jaw, 8mm round handle, straight

150mm, 6" 250-164-699

180mm, 7" 250-164-701

210mm, 8¹/₄" 250-164-703

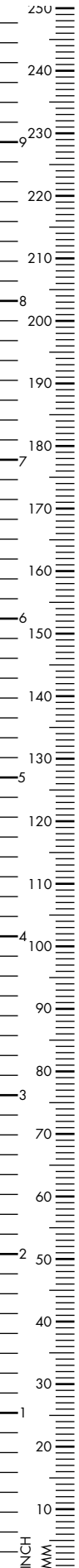

GERALD

Titanium Micro Ring Tip Forceps
1.0mm ring, flat handle

180mm, 7"	130-734-180
200mm, 8"	130-734-200



GERALD

Titanium Forceps, 6mm platform
1.0mm tip, flat handle

180mm, 7"	130-735-180
200mm, 8"	130-735-200
1x2 teeth, delicate	
180mm, 7"	130-728-180



GERALD

Titanium DeBaKey Forceps
1.2mm tip, flat handle

180mm, 7"	130-726-180
200mm, 8"	130-726-200



Ti

Titanium DeBaKey Vascular Forceps
wide flat handle, 1.0mm tip

160mm, 6^{1/4}" 130-881-160

200mm, 8" 130-881-200

240mm, 9^{1/2}" 130-881-240

1.5mm tip

160mm, 6^{1/4}" 130-882-160

200mm, 8" 130-882-200

240mm, 9^{1/2}" 130-882-240

2.0mm tip

160mm, 6^{1/4}" 130-884-160

200mm, 8" 130-884-200

240mm, 9^{1/2}" 130-884-240



Ti

CUSHING

Titanium Forceps, serrated, fluted handle
1.0mm tip

175mm, 6^{7/8}" 130-736-180

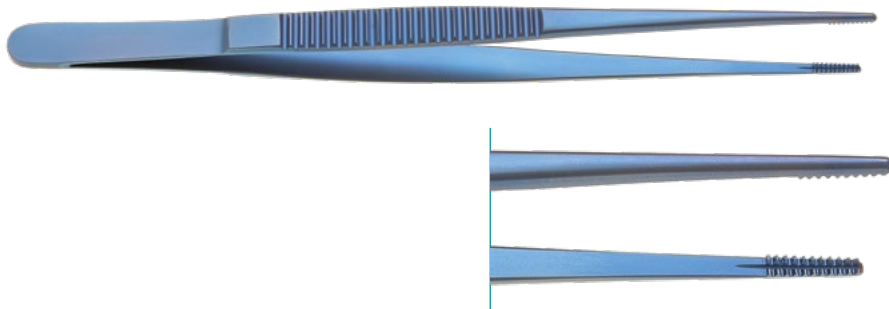

Ti

RESANO

Titanium Valve Forceps, multiple teeth,
wide flat handle

230mm, 9" 130-830-230

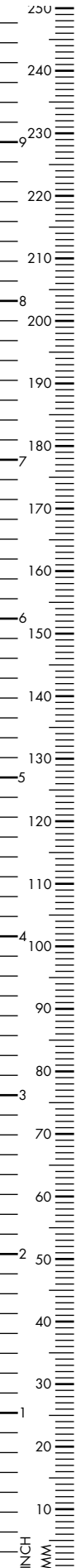

Micro Ring Tip Forceps
8mm round handle,
1mm straight ring tip

150mm, 6"	250-264-705
180mm, 7"	250-264-709
210mm, 8 ^{1/4} "	250-264-708

2mm straight ring tip

180mm, 7"	250-264-706
210mm, 8 ^{1/4} "	250-264-707

1mm straight ring tip, 10mm tying platform

180mm, 7"	250-264-701
-----------	-------------

1mm curved ring tip

210mm, 8 ^{1/4} "	250-264-703
---------------------------	-------------

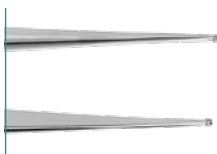

Micro Ring Tip Forceps
8mm round handle with counter balance,
1mm straight ring tip

150mm, 6"	251-655-145
180mm, 7"	251-655-180
210mm, 8 ^{1/4} "	251-655-210
230mm, 9"	251-655-230

2mm straight ring tip

180mm, 7"	251-655-182
-----------	-------------

1mm curved ring tip

180mm, 7"	251-655-181
230mm, 9"	251-655-231



Micro Suture Tying Forceps
6mm platform, 8mm round handle
straight tip

120mm, 4 ³ / ₄ "	250-264-280
140mm, 5 ¹ / ₂ "	250-264-284
curved tip	
120mm, 4 ³ / ₄ "	250-264-281
140mm, 5 ¹ / ₂ "	250-264-285



Micro Suture Tying Forceps,
6mm platform, 8mm round handle
0.8mm straight tip

180mm, 7"	250-265-180
210mm, 8 ¹ / ₄ "	250-267-210
straight tip with 1x2 teeth	
180mm, 7"	250-265-182
curved tip	
180mm, 7"	250-265-181
210mm, 8 ¹ / ₄ "	250-267-211



Micro Vascular Forceps, 9mm round handle
6mm platform tip with counter balance
straight tip

150mm, 6"	251-657-150
180mm, 7"	251-657-180
210mm, 8 ¹ / ₄ "	251-657-210
250mm, 9 ⁷ / ₈ "	251-657-250
straight tip with 1x2 teeth	
180mm, 7"	251-657-182
curved tip	
180mm, 7"	251-657-181
210mm, 8 ¹ / ₄ "	251-657-211
250mm, 9 ⁷ / ₈ "	251-657-251

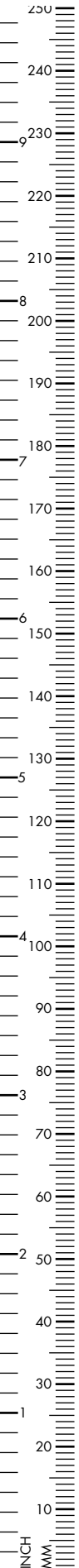

Micro Vascular Tying Forceps
8mm round handle, 180mm, 7"

straight tip	250-264-250
curved tip	250-264-251



DEBAKEY

Micro Vascular Forceps
8mm round handle, 1mm tip

180mm, 7"	130-212-180
210mm, 8 ^{1/4} "	130-212-210



DEBAKEY

Micro Vascular Forceps
8mm round handle, 1mm tip
with counter balance

180mm, 7"	250-653-180
210mm, 8 ^{1/4} "	250-653-210



GERALD

Micro Vascular Forceps, straight
1mm cross-serrated step-down tip,
flat handle

180mm, 7"	130-020-180
200mm, 8"	130-020-200
250mm, 9 ^{7/8} "	130-020-250



GERALD

Micro Ring Tip Forceps
Ø 1.0 x 0.5mm ring, flat handle

180mm, 7"	130-724-180
200mm, 8"	130-724-200



GERALD

Dressing Forceps, narrow
1mm step-down tip

180mm, 7"	130-022-180
200mm, 8"	130-022-200

with 6mm tying platform

180mm, 7"	130-731-180
200mm, 8"	130-731-200

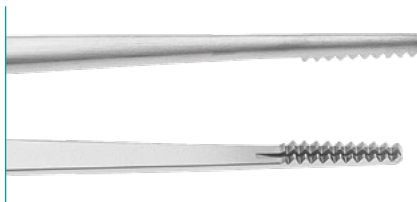
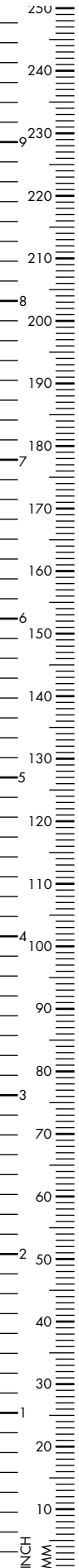

RESANO

Valve Forceps, multi-toothed

230mm, 9"	130-530-230
-----------	-------------



DEBAKEY

Needle Pulling Forceps, gold plated
8mm round handle, 2.0mm tip

180mm, 7"	250-571-180
-----------	-------------

1.2mm tip

180mm, 7"	250-571-185
-----------	-------------

210mm, 8 ¹ / ₄ "	250-571-200
--	-------------



Micro Jeweller Forceps
0.3mm tip, 9mm wide handle
straight tip

110mm, 4 ¹ / ₃ "	251-613-110
--	-------------

135mm, 5 ¹ / ₃ "	251-611-130
--	-------------



straight tip

110mm, 4 ¹ / ₃ "	251-713-110
--	-------------

135mm, 5 ¹ / ₃ "	251-711-130
--	-------------



45° angled tip

135mm, 5 ¹ / ₃ "	251-703-135
--	-------------



Micro Suture Tying Forceps
tip 0,3mm, smooth, 6mm tying platform,
stop pin, Ø8mm round handle,
120mm, 4^{3/4}"

straight	250-064-280
curved	250-064-281
angled	250-064-282

150mm, 6"

straight	250-064-284
curved	250-064-285

180mm, 7"

straight	250-064-286
curved	250-064-287

230mm, 9"

straight	250-064-288
curved	250-064-289



Micro Forceps, angled, 0.35mm

110mm, 4 ^{1/3} "	250-024-329
---------------------------	-------------



Micro Forceps, straight, 0.15mm

110mm, 4 ^{1/3} "	250-024-331
---------------------------	-------------



YASARGIL

Tumor Tissue Forceps, bayonet-shaped
Ø 3mm round cup

200mm, 8"	250-024-768
-----------	-------------

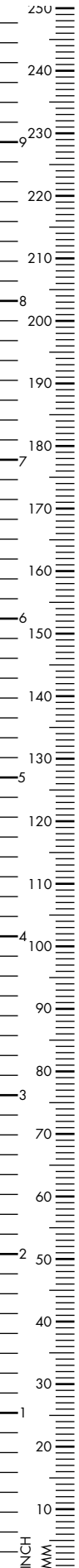

CASTROVIEJO

Suturing Forceps, 1x2 teeth, straight,
0.12mm, with tying platform, US-handle

110mm, 4^{1/3}" 400-137-021

0.3mm

110mm, 4^{1/3}" 400-137-031

0.5mm

110mm, 4^{1/3}" 400-137-055



BISHOP HARMON

Iris Forceps, 1x2 teeth, straight,
85mm, 3^{1/3}"

0.3mm 400-118-003

0.4mm 400-118-004

0.5mm 400-118-005

0.8mm 400-118-008



CASTROVIEJO BROWN

Tissue Forceps, 9x9 teeth, US-handle

110mm, 4^{1/3}" 400-139-050



Micro Needle Holder with streamline box catch
8mm round handle
straight jaw, with catch

150mm, 6" 250-064-309

straight jaw, without catch

150mm, 6" 250-064-319

curved jaw, with catch

150mm, 6" 250-064-329



JACOBSON

Micro Needle Holder with streamline box catch
8mm round handle
straight, with catch

185mm, 7¹/₄" 250-264-170

210mm, 8¹/₄" 250-264-172

230mm, 9" 250-264-174

straight, with catch, 9mm round handle

250mm, 9⁷/₈" 250-264-176

straight, 8mm round handle, without catch

185mm, 7¹/₄" 250-264-171

210mm, 8¹/₄" 250-264-173

230mm, 9" 250-264-175

curved, with catch

185mm, 7¹/₄" 250-264-177

210mm, 8¹/₄" 250-264-178

curved, 9mm round handle, without catch

250mm, 9⁷/₈" 250-264-179

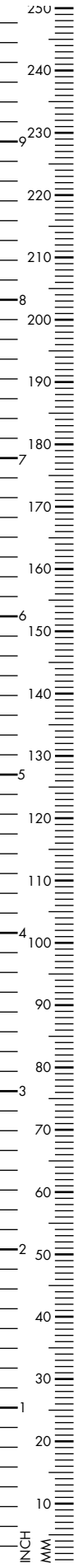

JACOBSON

Micro Needle Holder with regular box catch
8mm round handle
straight, with catch

185mm, 7 ¹ / ₄ "	250-264-100
210mm, 8 ¹ / ₄ "	250-264-102
230mm, 9"	250-264-104

straight, with catch, 9mm round handle

250mm, 9 ⁷ / ₈ "	250-264-106
--	-------------

straight, without catch

185mm, 7 ¹ / ₄ "	250-264-101
210mm, 8 ¹ / ₄ "	250-264-103
230mm, 9"	250-264-105

curved, with catch

185mm, 7 ¹ / ₄ "	250-264-107
210mm, 8 ¹ / ₄ "	250-264-108

curved, without catch,
9mm round handle

250mm, 9 ⁷ / ₈ "	250-264-109
--	-------------



JACOBSON

Needle Holder with streamline box catch
10mm round handle, for large needles

190mm, 7 ¹ / ₂ "	250-265-190
230mm, 9"	250-265-230
250mm, 9 ⁷ / ₈ "	250-265-250



CASTROVIEJO

Micro Needle Holder with regular box catch
flat handle, straight, with catch

150mm, 6"	250-362-150
180mm, 7"	250-362-185
210mm, 8 ^{1/4} "	250-362-215
230mm, 9"	250-362-230

straight, without catch

185mm, 7 ^{1/4} "	250-364-185
210mm, 8 ^{1/4} "	250-364-215

curved, with catch

180mm, 7"	250-363-185
210mm, 8 ^{1/4} "	250-363-215

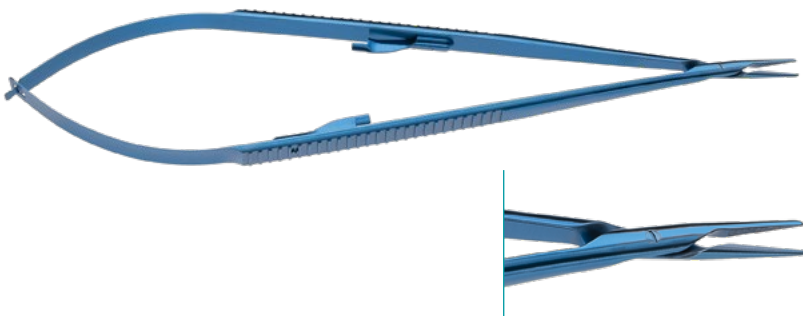

CASTROVIEJO

Micro Needle Holder with streamline box catch
flat handle, straight, with catch

180mm, 7"	250-362-160
210mm, 8 ^{1/4} "	250-362-162

straight, without catch

180mm, 7"	250-362-161
210mm, 8 ^{1/4} "	250-362-163

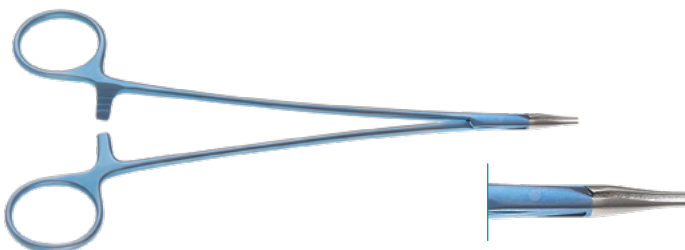

EUFRAF PASQUE

Micro Needle Holder, delicate jaw

150mm, 6"	180-662-150
170mm, 6 ^{2/3} "	180-662-170
190mm, 7 ^{1/2} "	180-662-190

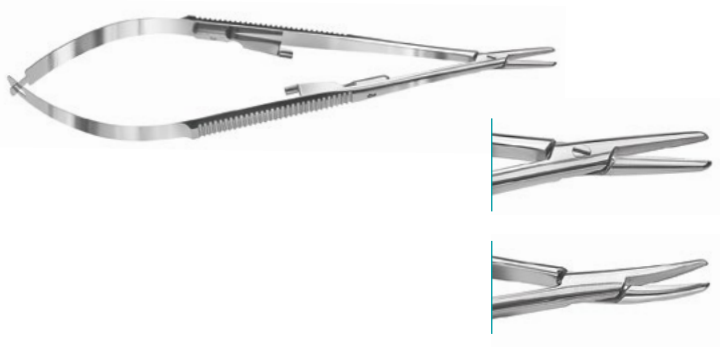

CASTROVIEJO

Micro Needle Holder, straight, smooth,
145mm, 5^{3/4}" , flat handle
with catch

straight	250-020-563
----------	-------------

curved	250-020-564
--------	-------------

without catch

straight	250-020-565
----------	-------------

curved	250-020-566
--------	-------------

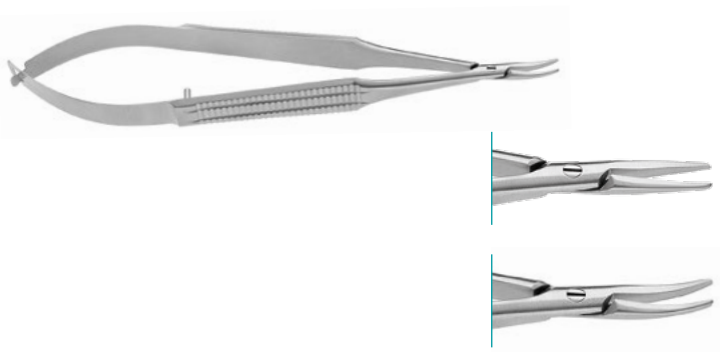

CASTROVIEJO

Micro Needle Holder,
straight, with catch, US-handle

140mm, 5 ^{1/2} "	250-064-076
---------------------------	-------------

curved, without catch

140mm, 5 ^{1/2} "	250-064-079
---------------------------	-------------



JACOBSON

Micro Needle Holder,
round handle, straight, with catch

185mm, 7 ^{1/4} "	250-064-246
---------------------------	-------------

210mm, 8 ^{1/4} "	250-064-251
---------------------------	-------------

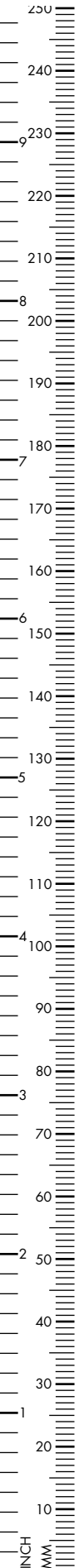

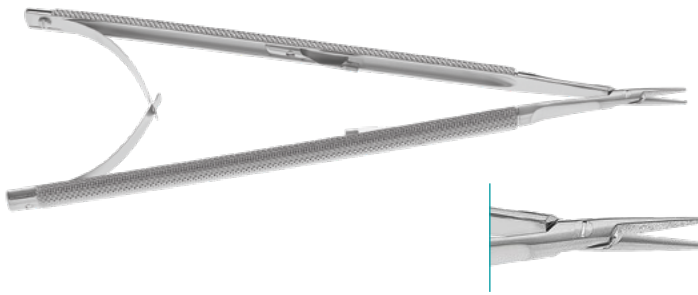

GLASSER

Micro Needle Holder,
with catch, straight

120mm, 4 ³ / ₄ "	180-100-120
--	-------------

180mm, 7"	180-100-180
-----------	-------------

curved

120mm, 4 ³ / ₄ "	180-101-180
--	-------------



BARRAQUER

Micro Needle Holder
straight, Ø 8mm round handle, smooth
without catch, 115mm, 4¹/₂"

straight	250-064-230
----------	-------------

curved	250-064-231
--------	-------------

with catch

straight	250-064-232
----------	-------------

curved	250-064-233
--------	-------------



BARRAQUER

Micro Needle Holder, 120mm, 4³/₄"
8mm round handle, straight

with catch	250-164-232
------------	-------------

without catch	250-164-234
---------------	-------------

curved

with catch	250-164-233
------------	-------------

without catch	250-164-231
---------------	-------------



REILL

Micro Needle Holder, 150mm, 6"
8mm round handle, 1mm tip, straight

with catch	250-164-242
------------	-------------

without catch	250-164-240
---------------	-------------

curved

with catch	250-164-243
------------	-------------

without catch	250-164-241
---------------	-------------

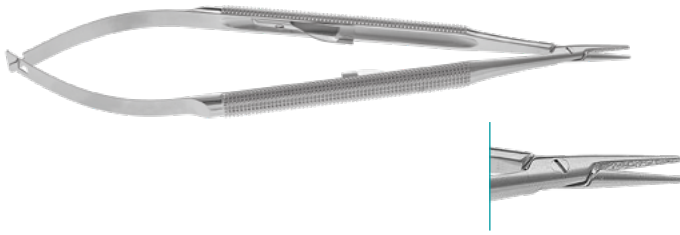
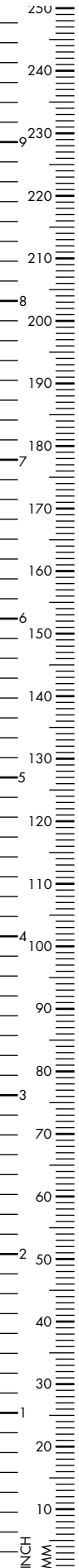

JACOBSON

Micro Needle Holder, 9mm round handle, 0.8mm tip, straight, 165mm, 6¹/₂"

with catch	250-164-252
without catch	250-164-253
curved	
with catch	250-164-254



JACOBSON

Micro Needle Holder, regular box catch, 9mm round handle, 0.8mm tip, straight with catch

180mm, 7"	250-264-246
210mm, 8 ¹ / ₄ "	250-264-210
230mm, 9"	250-264-230
straight, without catch	
180mm, 7"	250-264-248
210mm, 8 ¹ / ₄ "	250-264-211
230mm, 9"	250-264-231
curved, with catch	
180mm, 7"	250-264-247
210mm, 8 ¹ / ₄ "	250-264-212
230mm, 9"	250-264-232
curved, without catch	
180mm, 7"	250-264-249
210mm, 8 ¹ / ₄ "	250-264-213

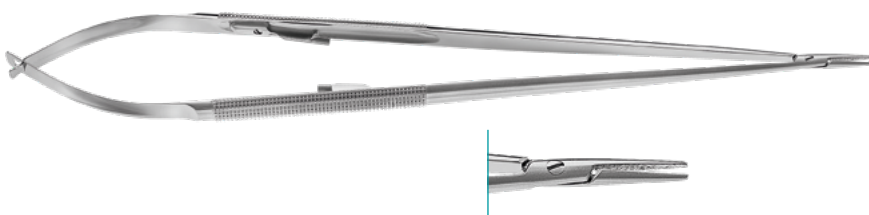

JACOBSON

Micro Needle Holder, regular box catch, 9mm round handle with short knurling, straight, 230mm, 9"

with catch	250-264-234
without catch	250-264-235
curved	
with catch	250-264-236

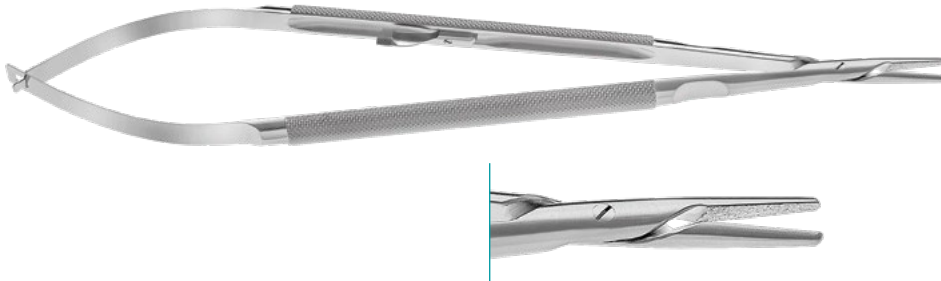

JACOBSON

Needle Holder, streamline box catch
10mm round handle for large needles
with catch, straight

190mm, 7¹/₂" 250-018-190

230mm, 9" 250-018-230

250mm, 9⁷/₈" 250-018-250

curved

230mm, 9" 250-019-230

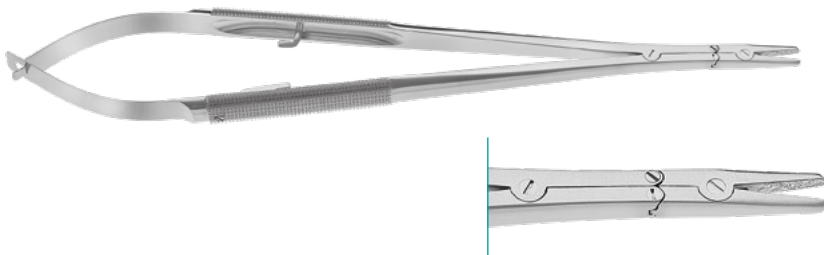

GREGORY

Needle Holder, double action jaw,
10mm round handle with catch,
for large needles, TC Inserts, 2mm tip

180mm, 7" 180-880-180

210mm, 8¹/₄" 180-880-210



diamond dusted jaw

180mm, 7" 180-881-180

210mm, 8¹/₄" 180-881-210



CASTROVIEJO

Micro Needle Holder, with catch
flat handle, 1mm tip, 140mm, 5¹/₂"

straight 250-220-563

curved 250-220-564

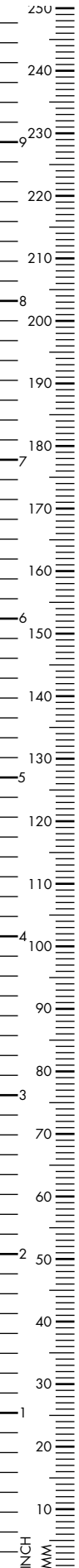

CASTROVIEJO JACOBSON

Micro Needle Holder
flat handle, straight, with catch

180mm, 7"	250-264-049
210mm, 8 ^{1/4} "	250-264-060
230mm, 9"	250-264-062
straight, without catch	
180mm, 7"	250-264-048
curved, without catch	
180mm, 7"	250-264-051



LÖFFLER

Needle Holder, delicate, short jaw,
straight, ring handle

150mm, 6"	180-755-150
180mm, 7"	180-755-180
200mm, 8"	180-755-200
230mm, 9"	180-755-230

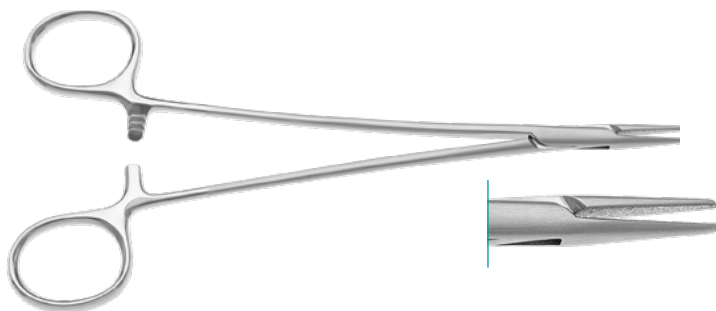

DEBAKEY

Needle Holder, straight, ring handle

180mm, 7"	180-648-180
200mm, 8"	180-648-200
230mm, 9"	180-648-230



Micro Scissors, 9mm blades, 120mm, 4³/₄"
7mm round handle, straight

sharp blades	250-060-120
blunt blades	250-060-121
curved	
sharp blades	250-061-120



Ti

JACOBSON

Micro Scissors, 9mm sharp blades
8mm round handle, straight

150mm, 6"	250-360-150
180mm, 7"	250-360-180
210mm, 8 ¹ / ₄ "	250-360-210
230mm, 9"	250-360-230
curved	
180mm, 7"	250-360-181



Ti

Micro Coronary Scissors, 180mm, 7"
10mm sharp angled blades
8mm round handle, 25°

with ball tip	250-360-025
without ball tip	250-360-125
45°	
with ball tip	250-360-045
without ball tip	250-360-145
60°	
with ball tip	250-360-060
without ball tip	250-360-160
90°	
with ball tip	250-360-090
without ball tip	250-360-190
125°	
with ball tip	250-360-325
without ball tip	250-360-225

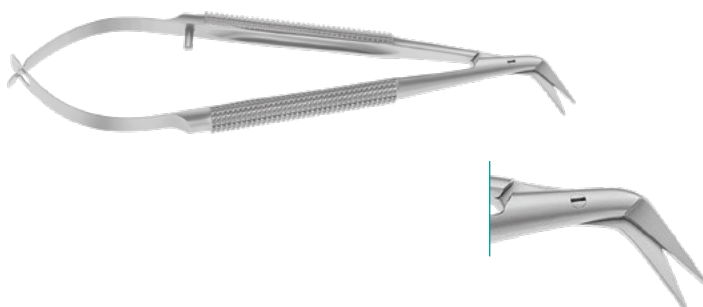
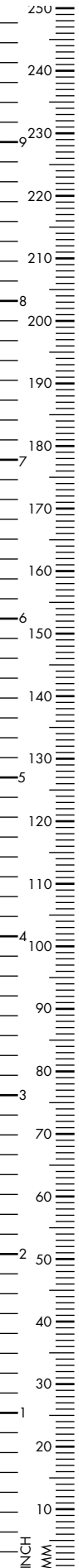

JACOBSON

Micro Scissors, 14mm blades
8mm round handle,
straight, 145mm, 5³/₄"

sharp blades 250-060-145

blunt blades 250-062-145

straight, 180mm, 7"

sharp blades 250-060-180

curved, 145mm, 5³/₄"

sharp blades 250-061-145

blunt blades 250-063-145

curved, 180mm, 7"

sharp blades 250-061-180

9mm round handle, straight, sharp blades

210mm, 8¹/₄" 250-060-210

230mm, 9" 250-060-230

9mm round handle, curved, sharp blades

210mm, 8¹/₄" 250-061-210

230mm, 9" 250-061-230

CASTROVIEJO

Micro Scissors, 115mm, 4¹/₂"

8mm round handle

angled fine blades, 10mm

25° 250-060-115

45° 250-061-115

60° 250-062-115

90° 250-063-115

125° 250-064-115

angled micro blades, 7mm

25° 250-060-215

45° 250-061-215

60° 250-062-215

90° 250-063-215

125° 250-065-215

NOYES

Iridectomy Scissors, straight

110mm, 4¹/₃"

blunt/blunt 400-120-050

blunt/sharp 400-120-051

sharp/sharp 400-120-052



Micro Scissors (Spring Type)
bayonet-shaped, straight

190mm, 7^{1/2}" 250-064-105

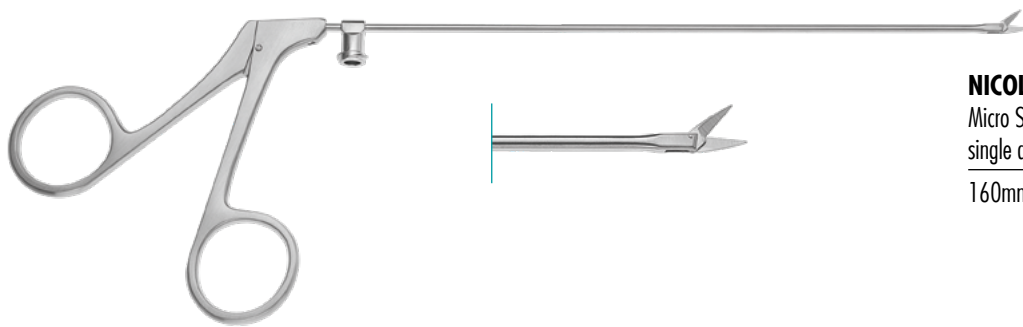

NICOLA

Micro Scissors, straight, sharp/sharp,
single action, with Luer-Catch

160mm, 6^{1/4}" 250-064-226



VANNAS

Micro Scissors, wide handle, angled

120mm, 4^{3/4}" 250-064-011

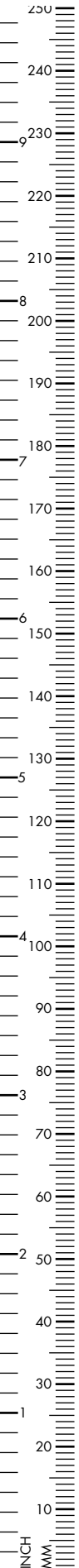

JACOBSON

Micro Coronary Scissors, 160mm, 6¹/₄"
sharp blades, 8mm round handle
7mm micro blades, angled

25°	120-164-025
45°	120-164-045
60°	120-164-060
90°	120-164-090
125°	120-164-125

10mm micro blades, angled

25°	120-164-225
45°	120-164-245
60°	120-164-260
90°	120-164-290
125°	120-164-325

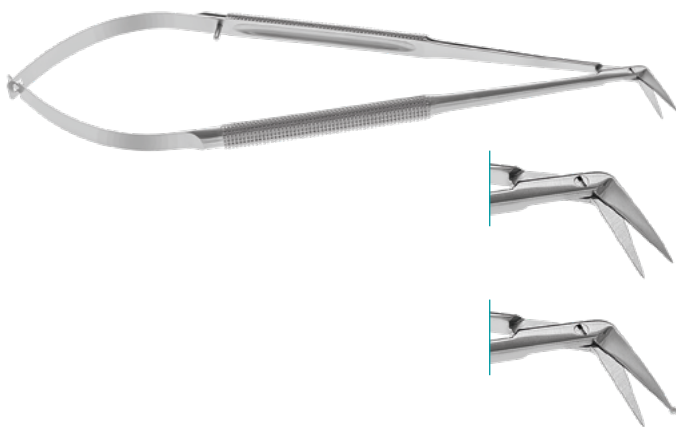

JACOBSON

Micro Coronary Scissors, 180mm, 7"
14mm blades, 8mm round handle
sharp blades

25°	120-184-225
45°	120-184-245
60°	120-184-260
90°	120-184-290
125°	120-184-325

ball tip blade

25°	120-184-425
45°	120-184-445
60°	120-184-460
90°	120-184-490
125°	120-184-525

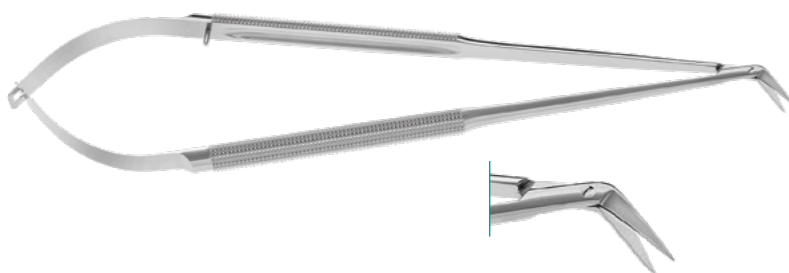

JACOBSON

Micro Coronary Scissors, 210mm, 8¹/₄"
14mm sharp blades, 8mm round handle

25°	120-210-025
45°	120-210-045
60°	120-210-060
90°	120-210-090
125°	120-210-125

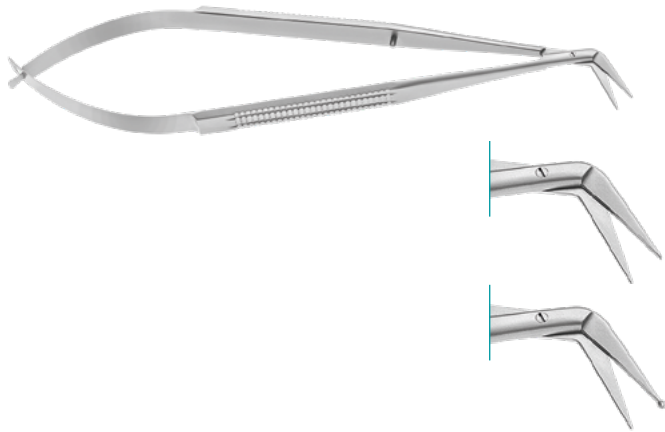

JACOBSON

Micro Coronary Scissors, 165mm, 6¹/₂"

14mm blades, flat handle

sharp tip

25° 120-184-025

45° 120-184-045

60° 120-184-060

90° 120-184-090

125° 120-184-125

ball tip

25° 120-183-025

45° 120-183-045

60° 120-183-060

90° 120-183-090

125° 120-183-125



JACOBSON

Micro Scissors, flat handle, 180mm, 7"

sharp tip

straight 120-150-185

curved 120-151-185



WESTCOTT

Micro Scissors, flat handle, 115mm, 4¹/₂"

sharp/sharp 400-102-110

blunt/blunt 400-103-110



VANNAS

Capsulotomy Scissors, flat handle, 85mm, 3¹/₃"

straight 400-842-085

curved 400-843-085

angled up 400-844-085

