

GALLBLADDER INSTRUMENTS



Forceps
Stone Forceps
Gall Duct Probes
Stone Scoops



PETIT MIXTER

Forceps, 90° angled

140mm, 5 ¹ / ₂ "	140-373-140
180mm, 7"	140-373-180

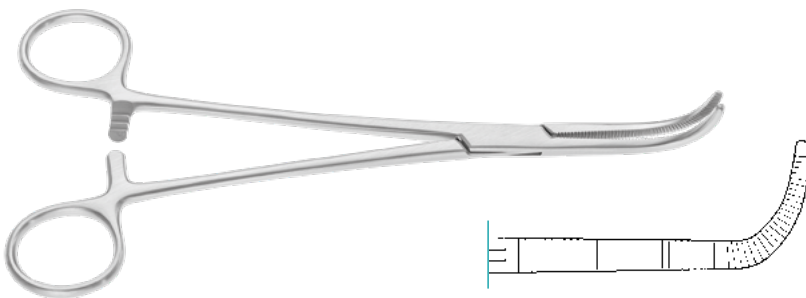

MIXTER

Forceps, fully serrated

155mm, 6 ¹ / ₈ "	140-423-155
190mm, 7 ¹ / ₂ "	140-423-190

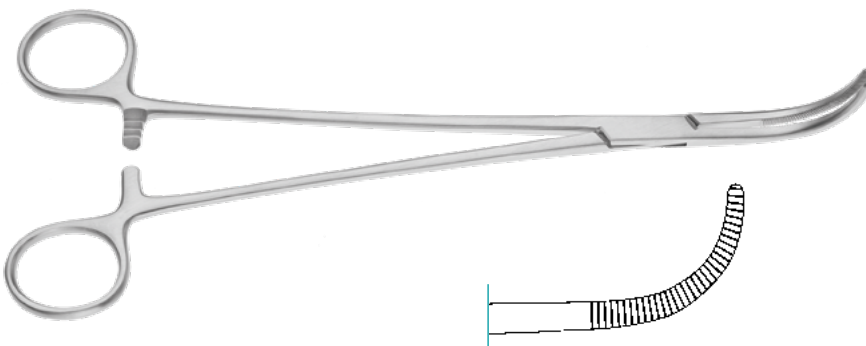

MIXTER

Kidney Pedicle Forceps

230mm, 9"	140-429-230
-----------	-------------

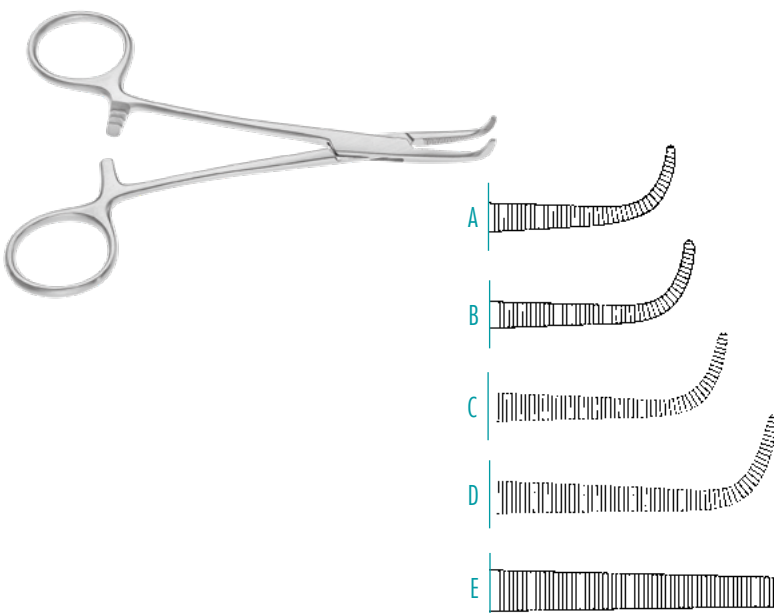

GEMINI

Dissecting Forceps

A 130mm, 5 ¹ / ₈ "	140-361-130
B 180mm, 7"	140-361-180
C 200mm, 8"	140-361-200
D 230mm, 9"	140-361-230
E 280mm, 11"	140-361-280

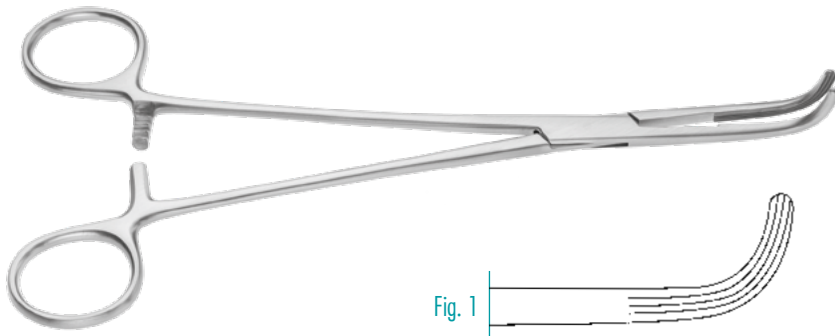

Fig. 1



Fig. 2

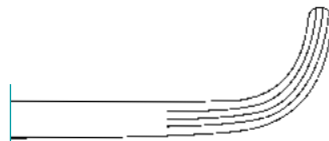
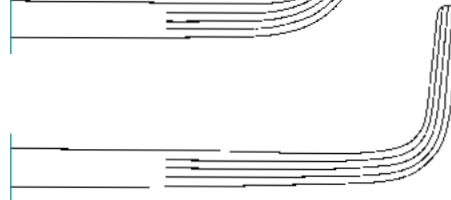

Fig. 3



Fig. 4



MIXTER

Gall Duct Forceps, Fig. 1

190mm, 7^{1/2}" 140-433-190

Fig. 2

220mm, 8^{2/3}" 140-433-220

Fig. 3

250mm, 9^{7/8}" 140-433-250

Fig. 4

280mm, 11" 140-433-280

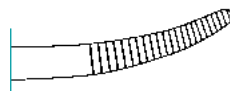
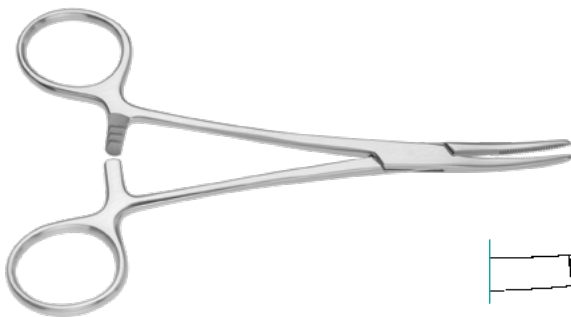

MOYNIHAN

Artery Forceps, delicate, curved

150mm, 6" 140-303-150

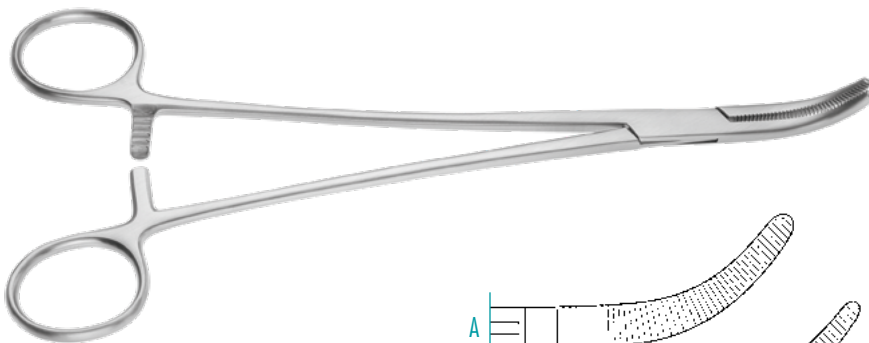

A

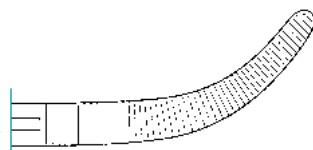

B

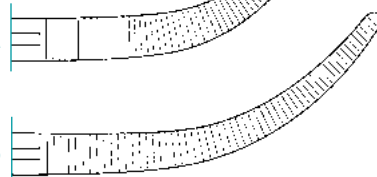

MOYNIHAN

Hysterectomy Forceps, curved

A 230mm, 9" 140-645-230

B 240mm, 9^{1/2}" 140-647-240

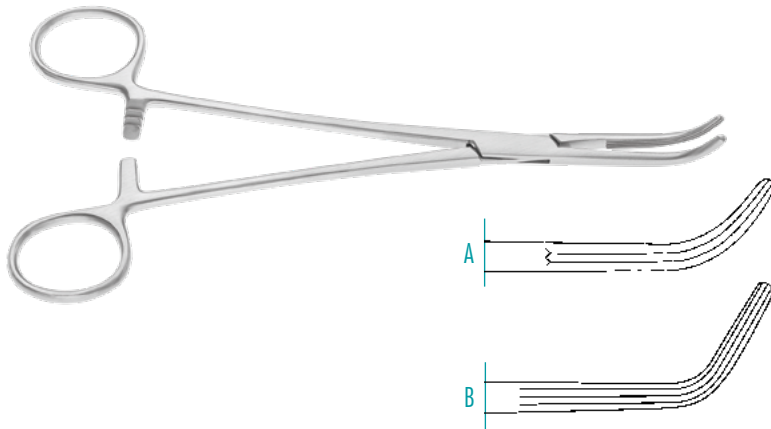

LAHEY

Gall Duct Forceps, curved, longitudinal serration

A 190mm, 7¹/₂" 140-439-190

B 230mm, 9" 140-439-230

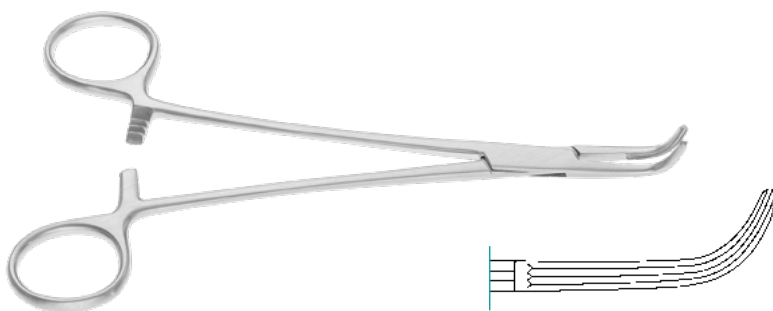

LOWER

Gall Duct Forceps, curved, longitudinal serration

185mm, 7¹/₄" 140-437-180

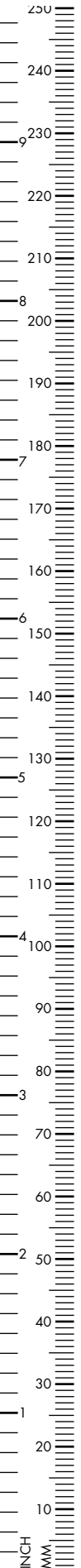

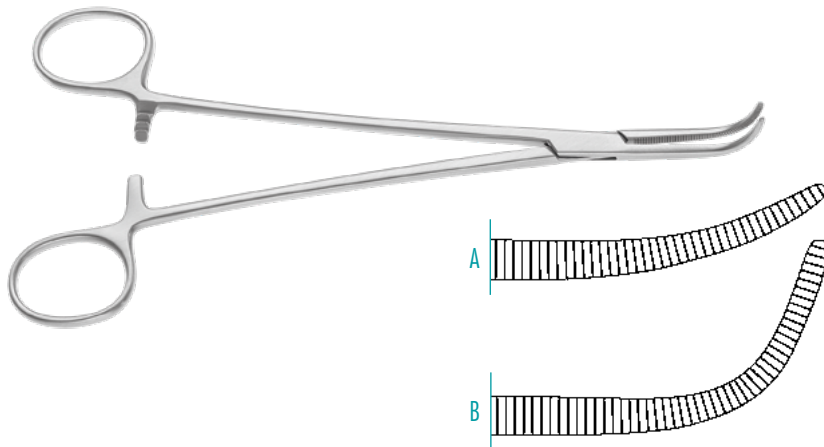

VARCO

Gallbladder Forceps, slightly curved

A 190mm, 7¹/₂" 140-403-190

B fully curved

200mm, 8" 140-403-200

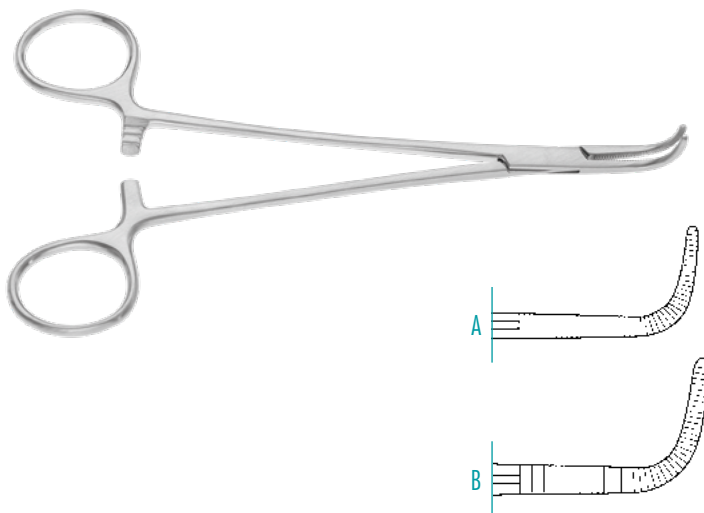

MEEKER

Kidney Pedicle Clamp

Fig. 1

A 180mm, 7" 140-619-180

Fig. 2

B 280mm, 11" 140-619-275

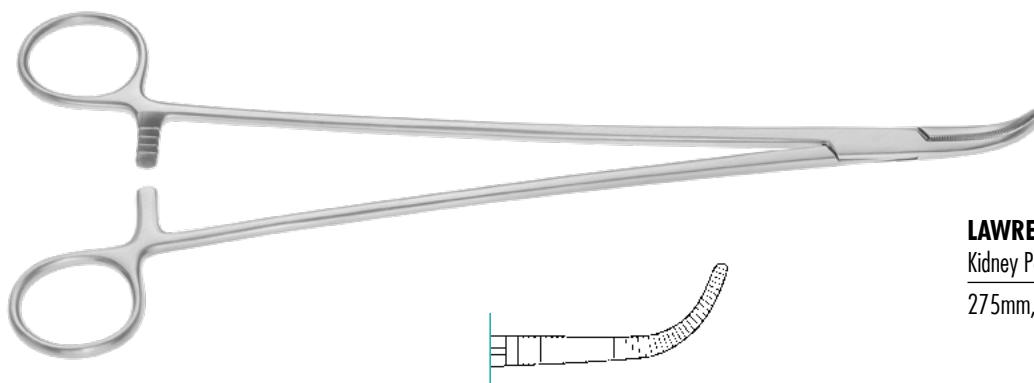

LAWRENCE

Kidney Pedicle Clamp

275mm, 10⁷/₈" 140-617-275

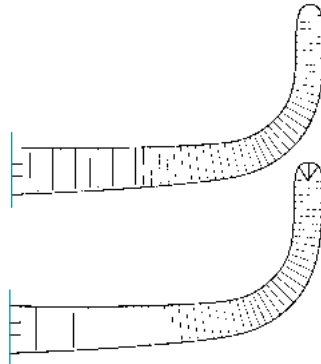
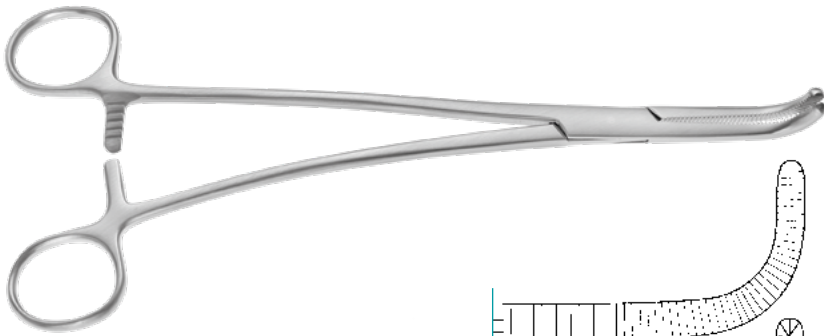
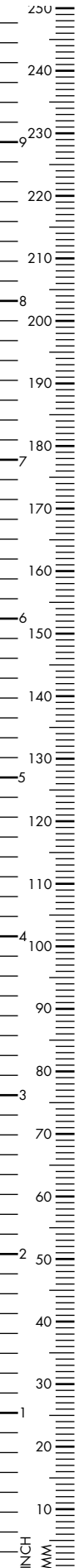

GRAY

Gall Duct Forceps, s-curved

220mm, 8²/₃" 140-607-220

230mm, 9" 140-607-230

1x2 teeth

220mm, 8²/₃" 140-608-220

230mm, 9" 140-608-230

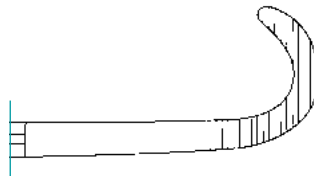
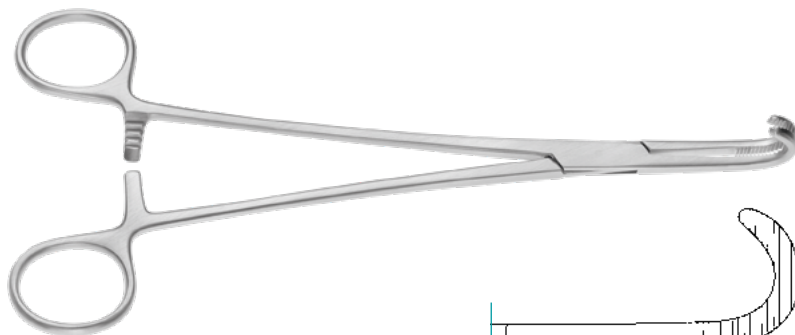

DESJARDINS

Gall Duct Forceps, curved

210mm, 8¹/₂" 140-609-210

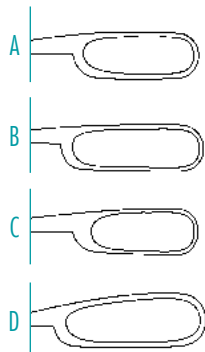
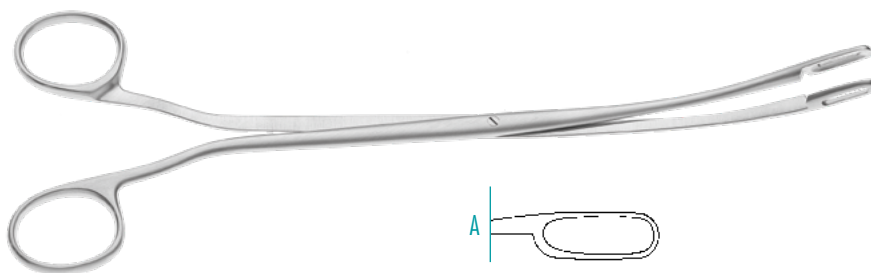

DESJARDINS

Gall Stone Forceps, 230mm, 9"

A #1 320-111-230

B #2 320-112-230

C #3 320-113-230

D #4 320-114-230



PELKMANN
Swab Forceps

straight	150-045-250
curved	150-046-250

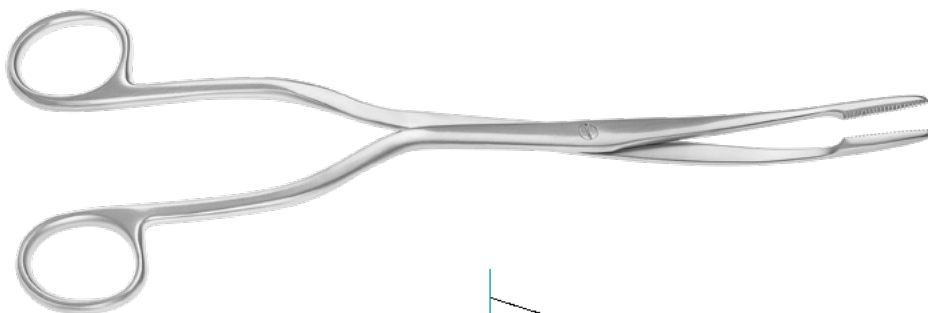
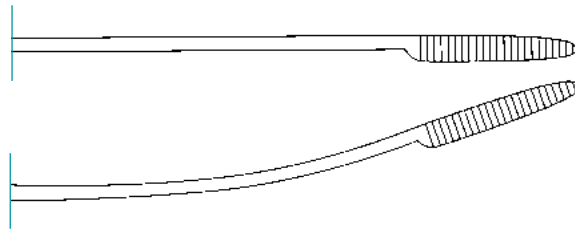

CZERNY
Gall Stone Forceps

245mm, 9 ² / ₃ "	320-135-245
--	-------------

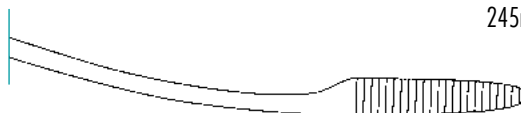

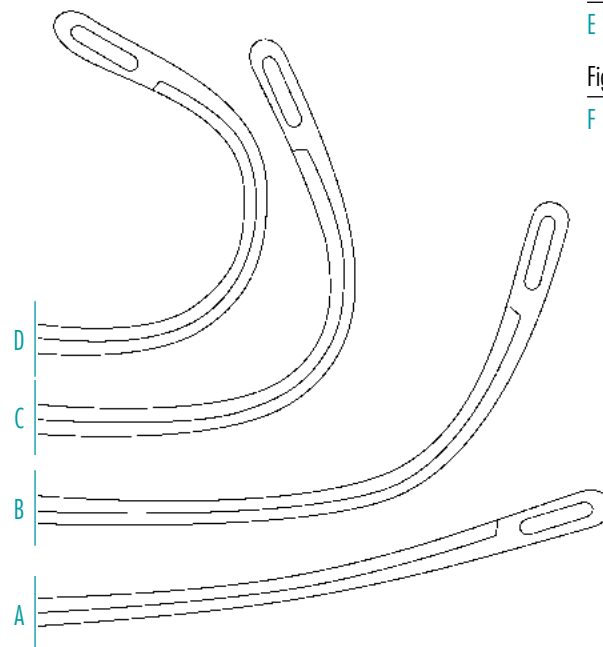
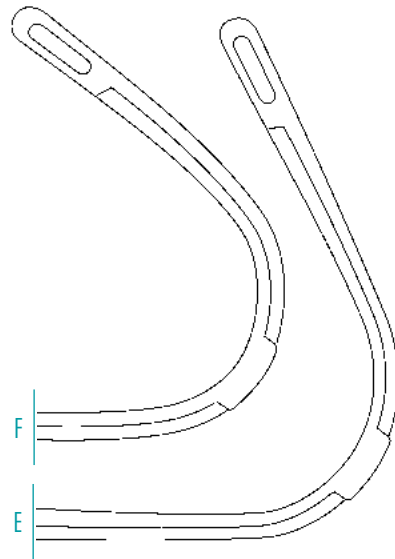

RANDALL

Kidney Stone Forceps

Fig. 1

A 230mm, 9" 320-101-230

Fig. 2

B 220mm, 8²/₃" 320-103-220

Fig. 3

C 220mm, 8²/₃" 320-105-220

Fig. 4

D 220mm, 8²/₃" 320-107-220

Fig. 5

E 190mm, 7¹/₂" 320-109-190

Fig. 6

F 190mm, 7¹/₂" 320-111-190

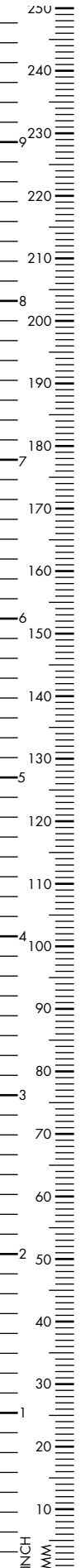

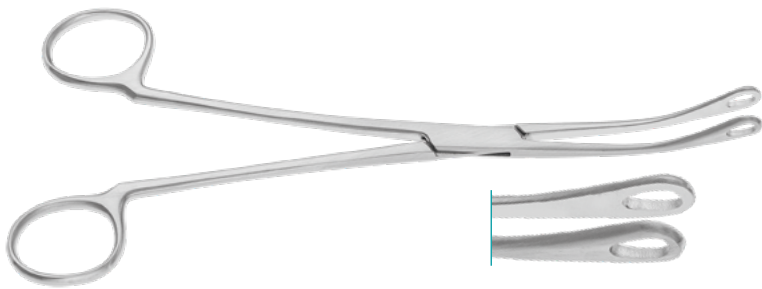

BLAKE

Gall Stone Forceps, 200mm, 8"

Straight	320-117-200
Curved	320-116-200

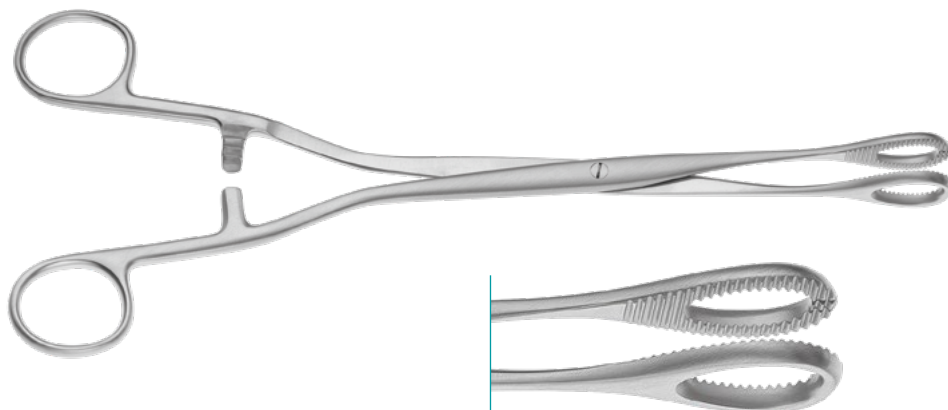

HEYWOOD SMITH

Gall Bladder Forceps

210mm, 8 ¹ / ₄ "	350-491-210
250mm, 9 ⁷ / ₈ "	350-491-250

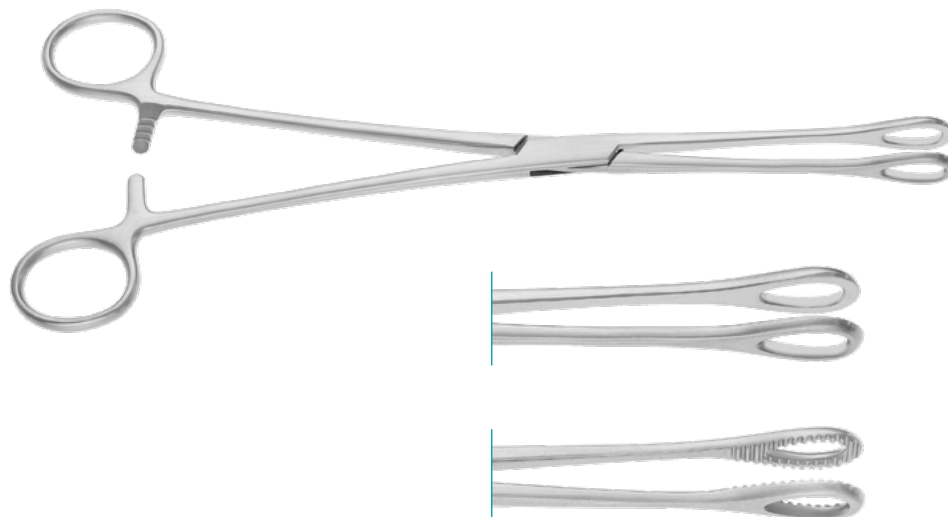

FOERSTER

Sponge Forceps, smooth, straight

180mm, 7"	150-050-180
250mm, 9 ⁷ / ₈ "	150-050-250

smooth, curved

180mm, 7"	150-053-180
250mm, 9 ⁷ / ₈ "	150-053-250

serrated, straight

180mm, 7"	150-052-180
250mm, 9 ⁷ / ₈ "	150-052-250
355mm, 14"	150-052-355
410mm, 16"	150-052-410

serrated, curved

180mm, 7"	150-055-180
250mm, 9 ⁷ / ₈ "	150-055-250

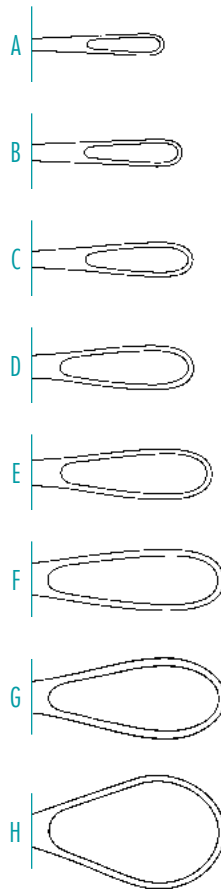

LUER KOERTE

Gall Stone Scoop, malleable, 320mm, 12^{1/2}"

Fig. 000

A 2.8mm 320-140-300

Fig. 00

B 3.4mm 320-140-200

Fig. 0

C 4.3mm 320-140-100

Fig. 1

D 5.5mm 320-140-010

Fig. 2

E 6.7mm 320-140-020

Fig. 3

F 8.0mm 320-140-030

Fig. 4

G 11.0mm 320-140-040

Fig. 5

H 15.0mm 320-140-050

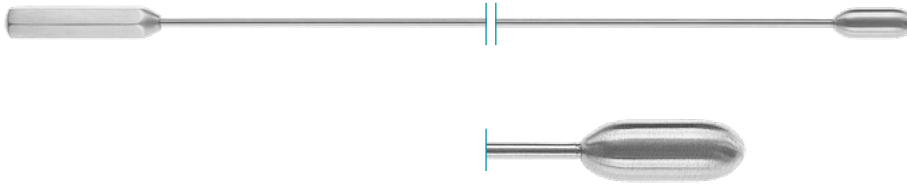

BAKES

Gall Duct Probe, 300mm, 11⁷/₈"

∅ 1mm	320-150-001
∅ 2mm	320-150-002
∅ 3mm	320-150-003
∅ 4mm	320-150-004
∅ 5mm	320-150-005
∅ 6mm	320-150-006
∅ 7mm	320-150-007
∅ 8mm	320-150-008
∅ 9mm	320-150-009
∅ 10mm	320-150-010
∅ 11mm	320-150-011

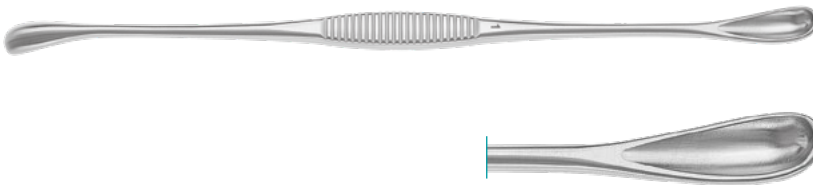

FERGUSON

Gall Stone Scoop, Fig.2, 11/12mm

215mm, 8 ¹ / ₂ "	320-150-215
--	-------------



MAYO

Gall Stone Scoop

270mm, 10 ² / ₃ "	320-152-270
---	-------------

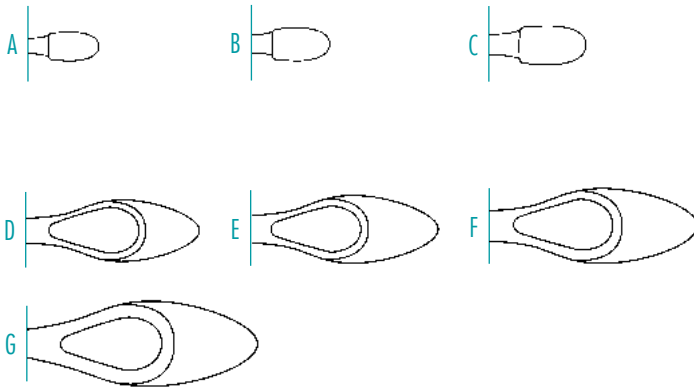
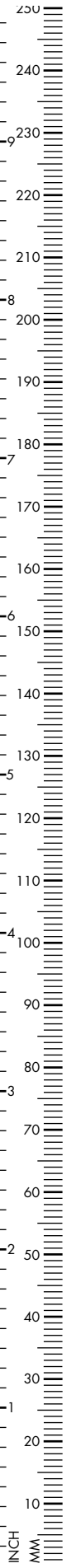

DESJARDINS

Gall Duct Probe, 280mm, 11"

A 13 Charr.	320-151-001
B 18 Charr.	320-151-002
C 21 Charr.	320-151-003

Scoop

D 18 Charr.	320-121-001
E 21 Charr.	320-121-002
F 24 Charr.	320-121-003
G 27 Charr.	320-121-004



MOYNIHAN

Gall Duct Probe / Scoop

340mm, 13 ¹ / ₃ "	320-142-340
---	-------------

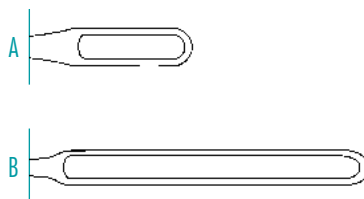

MAYO

Gall Stone Scoop,
working length: 270mm, 10²/₃"

A small	320-153-001
B medium	320-153-002

