

OBSTETRICS & GYNECOLOGY

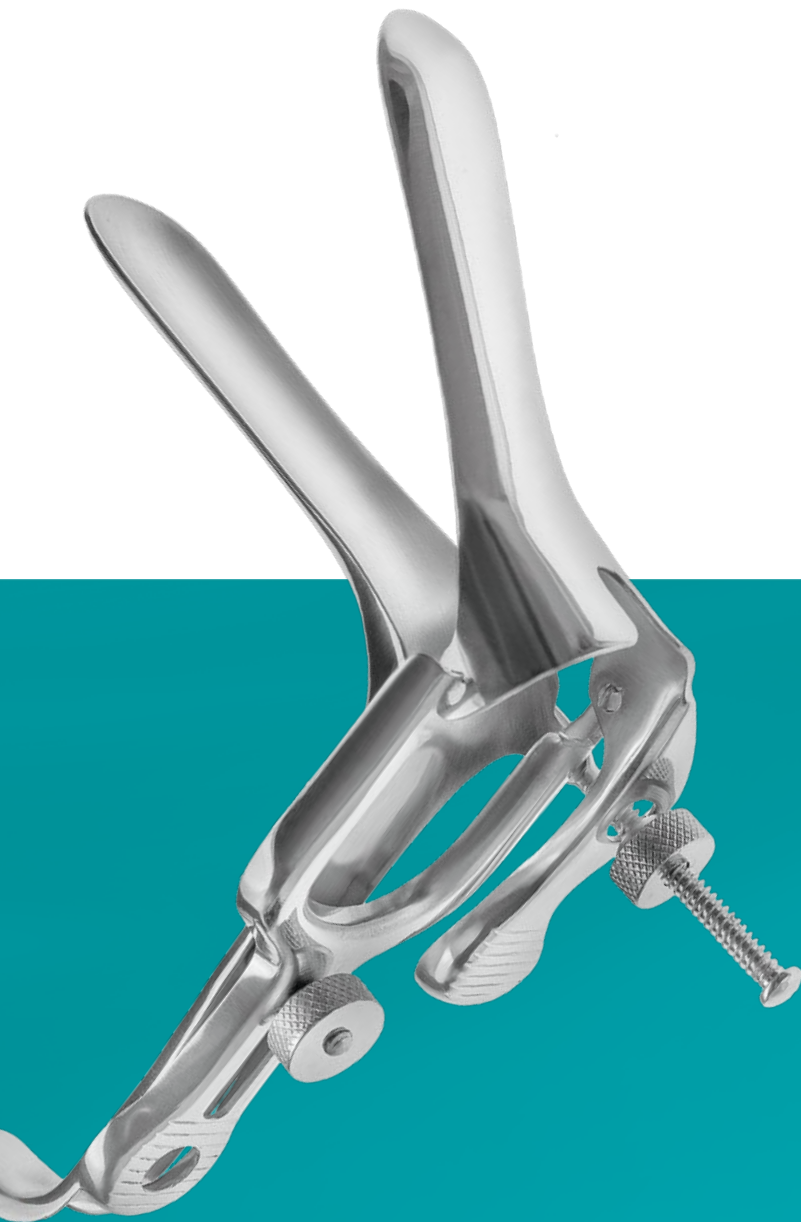

Scissors
Clamps and Forceps
Hysterectomy Forceps
Uterus Forceps
Tenaculum Forceps
Uterine / Placenta Forceps
Obstetrical Forceps
Myoma Screws
Curettes
Amniotome
Uterine Scoops/Curettes
Biopsy Forceps
Probes/Dilators
Retractors/Specula
Pelvimeter

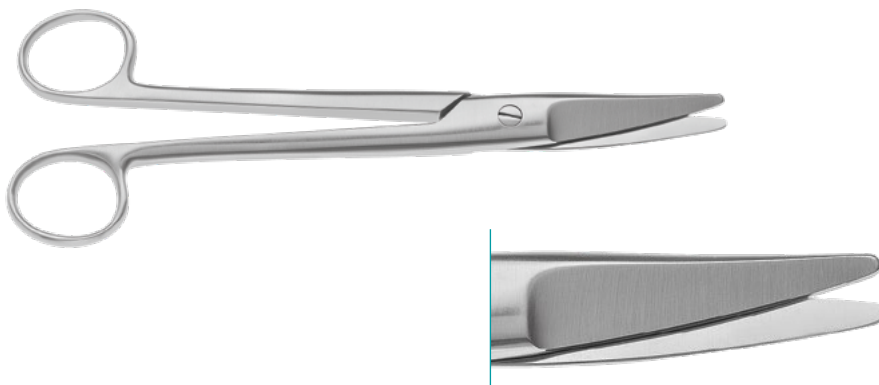

MAYO NOBLE

Scissors, curved

170mm, 6²/₃"

120-049-170

190mm, 7¹/₂"

120-049-190

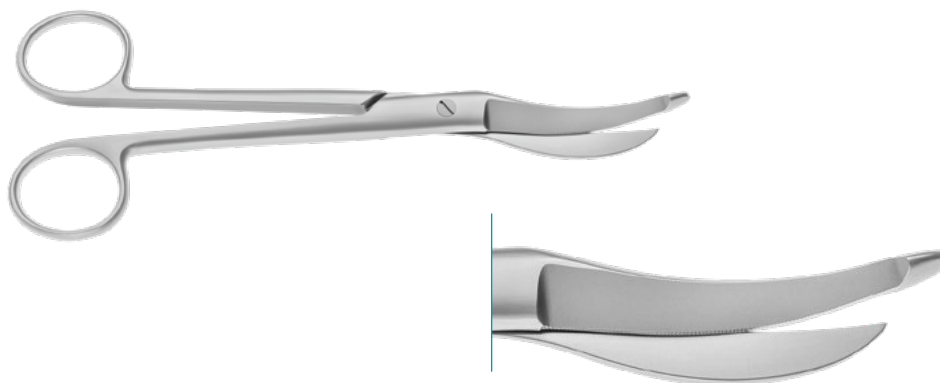

WALDMANN

Episiotomy Scissors, curved, serrated

180mm, 7"

120-231-180



BRAUN STADLER

Episiotomy Scissors

145mm, 5³/₄"

120-225-145

200mm, 8"

120-225-200

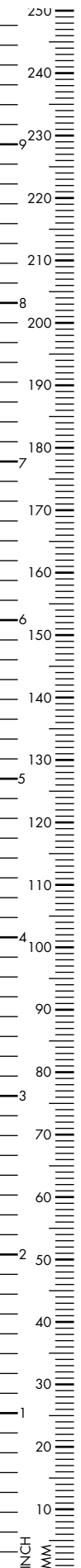

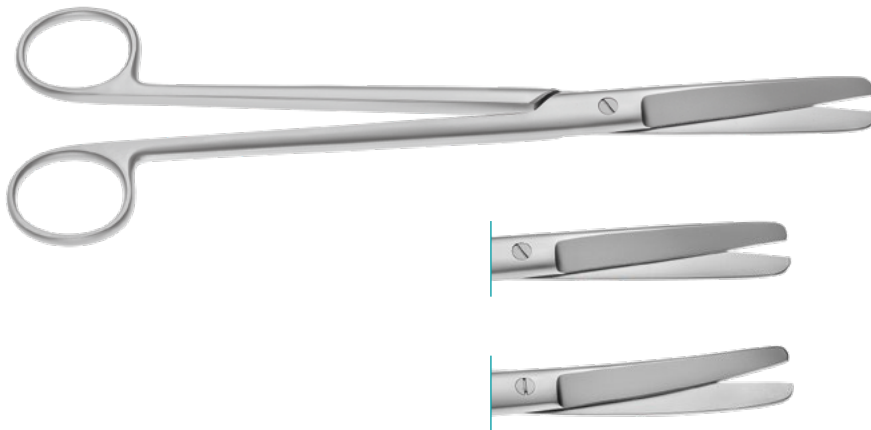

SIMS

Gynecological Scissors, straight, blunt/blunt

200mm, 8" 120-062-200

230mm, 9" 120-062-230

curved

200mm, 8" 120-063-200

230mm, 9" 120-063-230

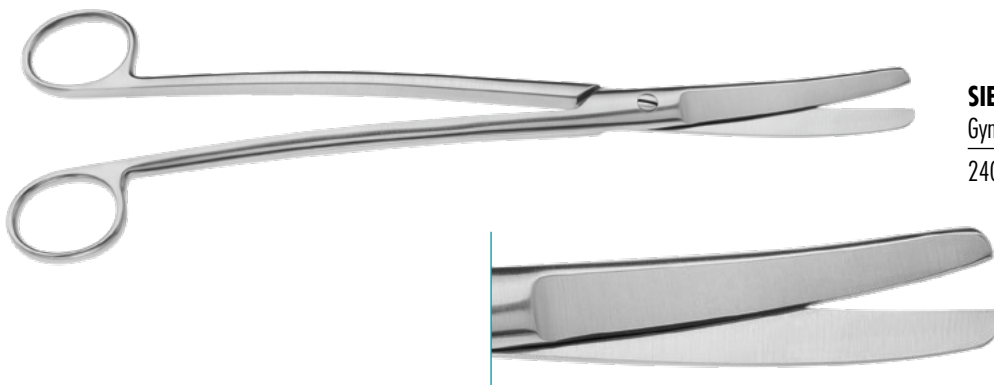

SIEBOLD

Gynecological Scissors, s-curved

240mm, 9^{1/2}" 120-061-240

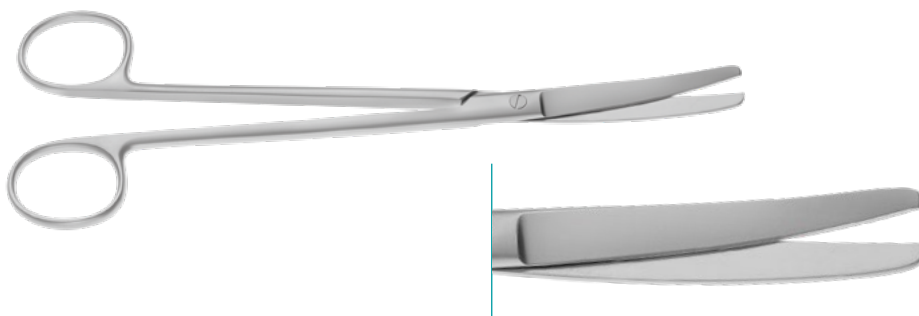

WERTHEIM

Preparation Scissors, curved

195mm, 7^{3/4}" 120-053-195

225mm, 8^{7/8}" 120-053-225

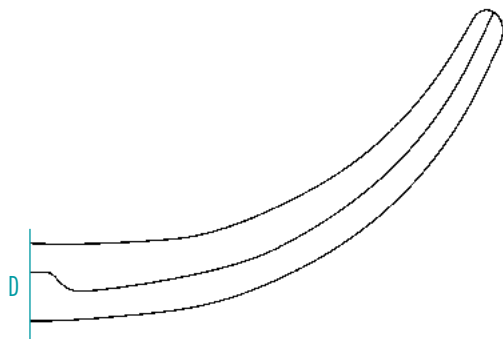
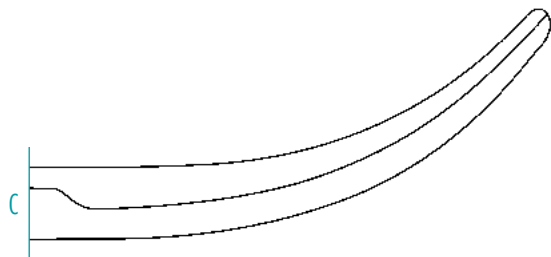
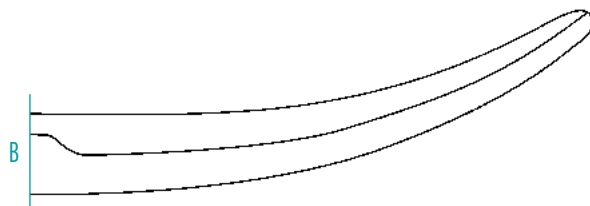
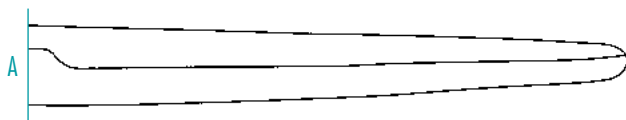
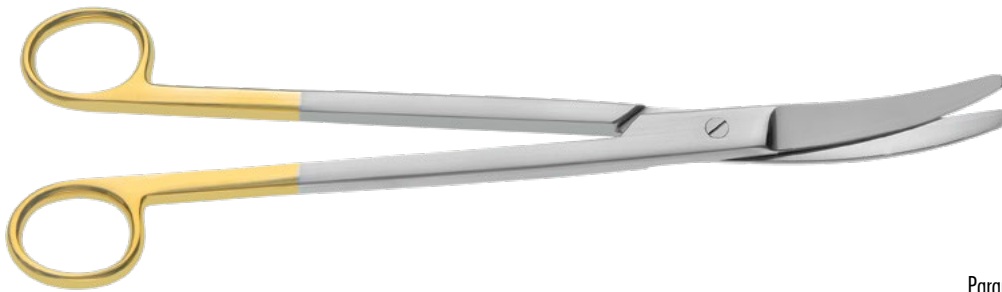

Parametrium Scissors, TC
230mm, 9"

| | |
|-------------------|-------------|
| A straight | 120-537-001 |
| B slightly curved | 120-537-002 |
| C strongly curved | 120-537-003 |
| D angled | 120-537-004 |

265mm, 10^{1/2}"

| | |
|-------------------|-------------|
| A straight | 120-536-001 |
| B slightly curved | 120-536-002 |
| C strongly curved | 120-536-003 |
| D angled | 120-536-004 |

Parametrium Scissors, TC
305mm, 12"

| | |
|-------------------|-------------|
| A straight | 120-538-001 |
| B slightly curved | 120-538-002 |
| C strongly curved | 120-538-003 |
| D angled | 120-538-004 |

Parametrium Scissors, TC
350mm, 14"

| | |
|-------------------|-------------|
| A straight | 120-539-001 |
| B slightly curved | 120-539-002 |
| C strongly curved | 120-539-003 |
| D angled | 120-539-004 |

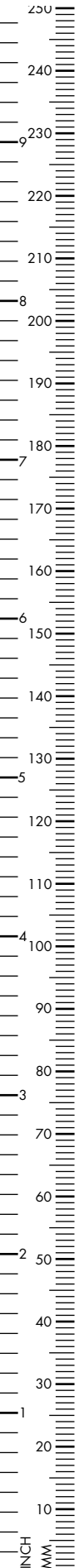



MODEL USA

Umbilical Cord Scissors

105mm, 4¹/₃"

120-233-105



BUSCH

Umbilical Cord Scissors, lateral curved

160mm, 6¹/₄"

120-229-160



SCHUMACHER

Umbilical Cord Scissors

160mm, 6¹/₄"

120-227-160

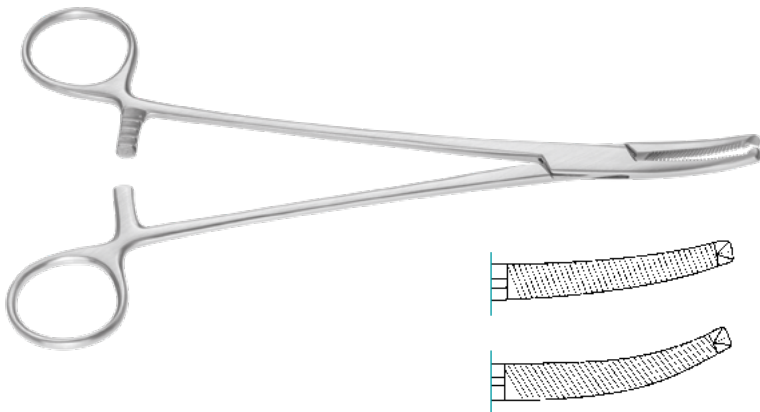

FAURE

Peritoneal Forceps, 200mm, 8"

Fig. 1 140-551-200

slightly curved

Fig. 2 140-553-200

strongly curved

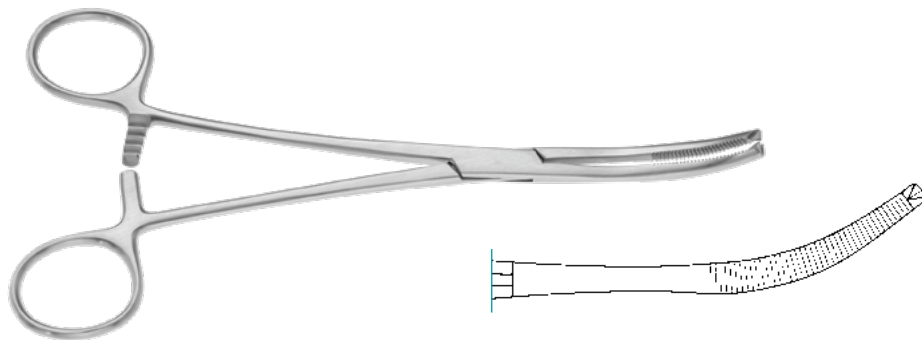

MIKULICZ

Peritoneal Forceps, strongly curved, 1x2 teeth

180mm, 7" 140-549-185

200mm, 8" 140-549-200

laterally curved, 1x2 teeth

180mm, 7" 140-549-180

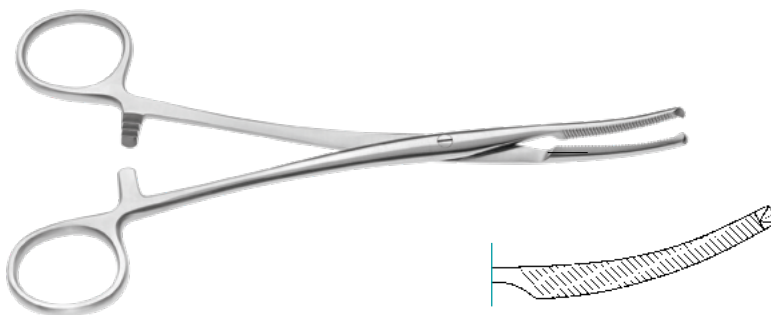

MIKULICZ

Peritoneal Forceps, curved, 1x2 teeth

180mm, 7" 140-548-180

200mm, 8" 140-548-200

245mm, 9²/₃" 140-548-245

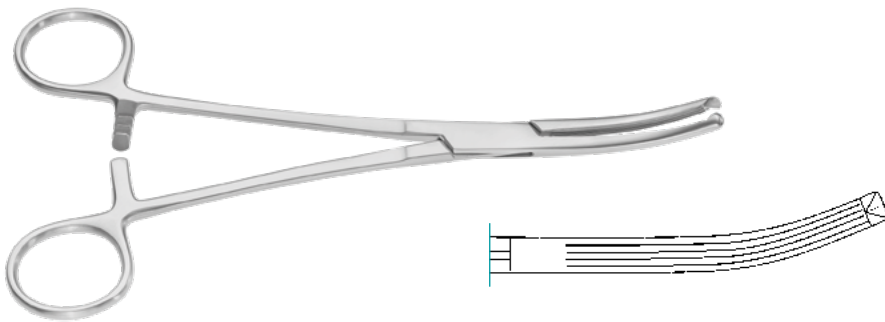

LONG

Hysterectomy Forceps, 1x2 teeth

190mm, 7^{1/2}"

140-652-190

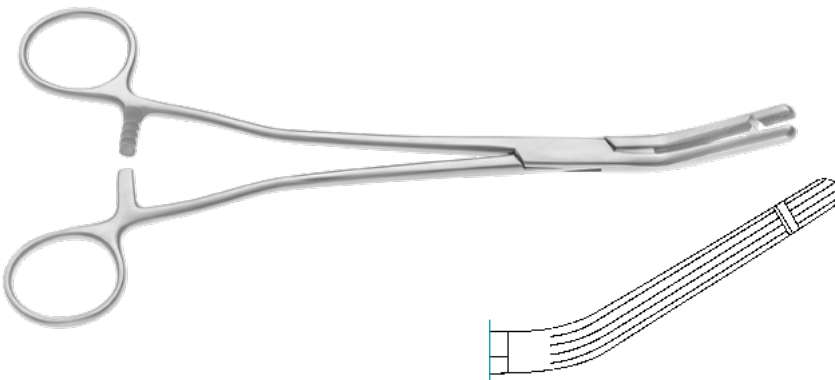

GARLAND

Hysterectomy Forceps, 1x2 teeth

210mm, 8^{1/4}"

140-639-210

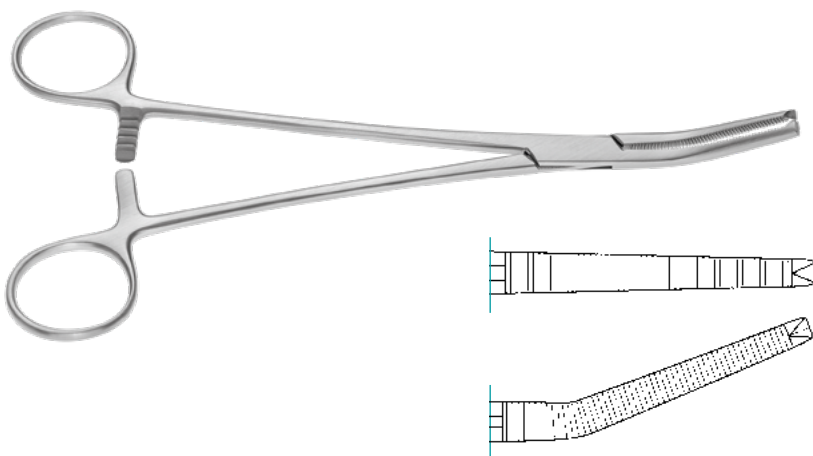

PHANEUF

Peritoneal Forceps, 1x2 teeth,
straight

215mm, 8^{1/2}"

140-520-210

curved

210mm, 8^{1/4}"

140-521-210

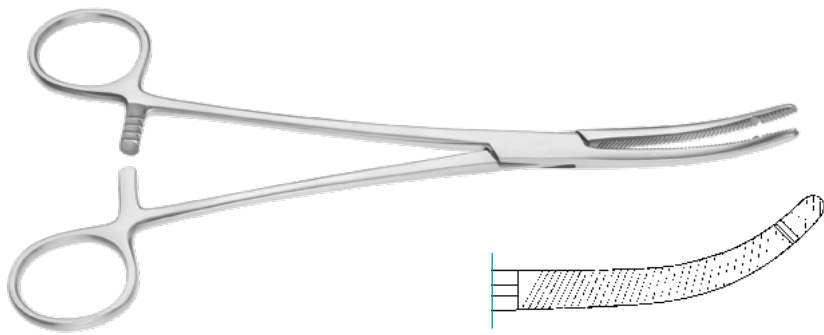

HEANEY

Hysterectomy Forceps, delicate, single tooth, curved

210mm, 8^{1/4}"

140-612-210

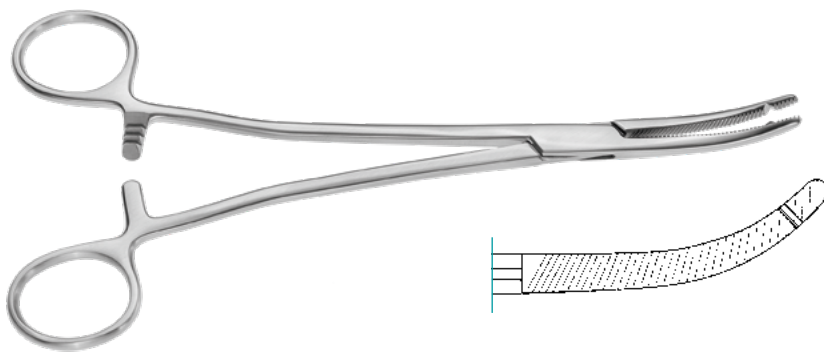

HEANEY

Hysterectomy Forceps, single tooth, curved

210mm, 8^{1/4}"

140-613-210

230mm, 9"

140-613-230

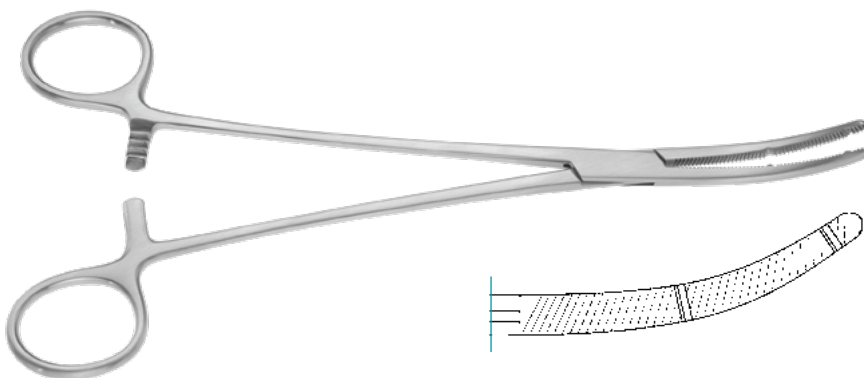

HEANEY

Hysterectomy Forceps, double tooth, curved

210mm, 8^{1/4}"

140-615-210

230mm, 9"

140-615-230

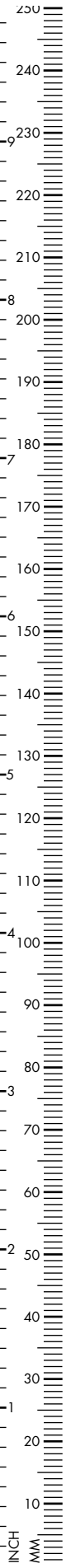

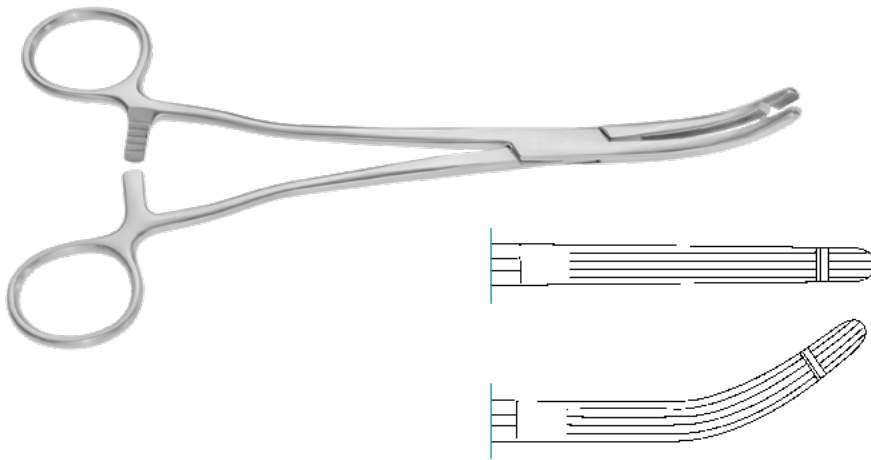

BALLANTINE

Hysterectomy Forceps, straight, single tooth

210mm, 8¹/₄" 140-617-210

300mm, 11⁷/₈" 140-617-300

curved

210mm, 8¹/₄" 140-618-210

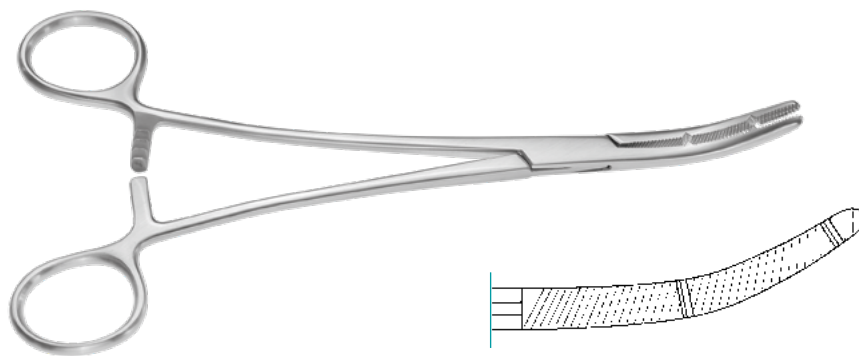

HEANEY KANTER

Hysterectomy Forceps, curved, single tooth

210mm, 8¹/₄" 140-619-210

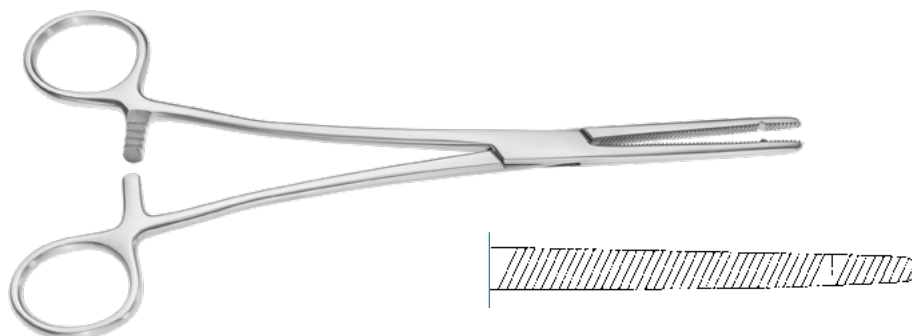

HEANEY REZEK

Hysterectomy Forceps, straight, single tooth

210mm, 8¹/₄" 140-627-210

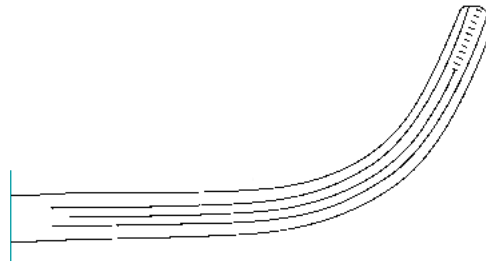

GUPTA FRANK

Forceps, s-curved, 80mm jaw length

240mm, 9¹/₂" 140-707-240

270mm, 10²/₃" 140-707-270

320mm, 12¹/₂" 140-707-320

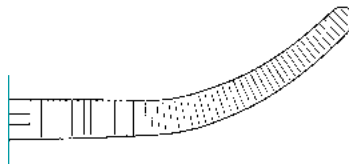
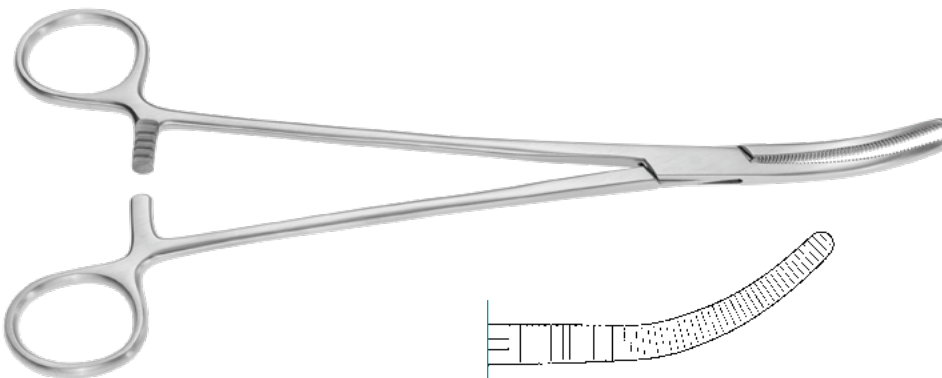

WERTHEIM

Hysterectomy Forceps, serrated, curved

250mm, 9⁷/₈" 140-697-250

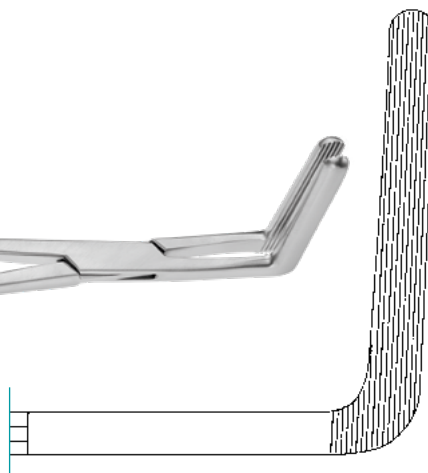
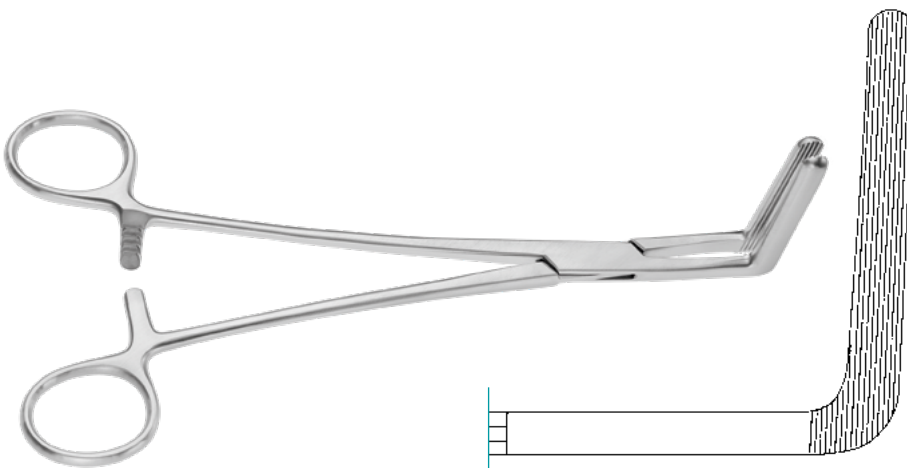

WERTHEIM CULLEN

Hysterectomy Forceps, 90° angled

215mm, 8¹/₂" 140-641-215

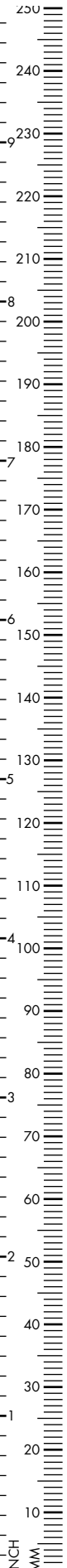

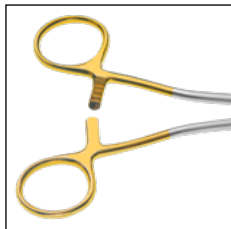
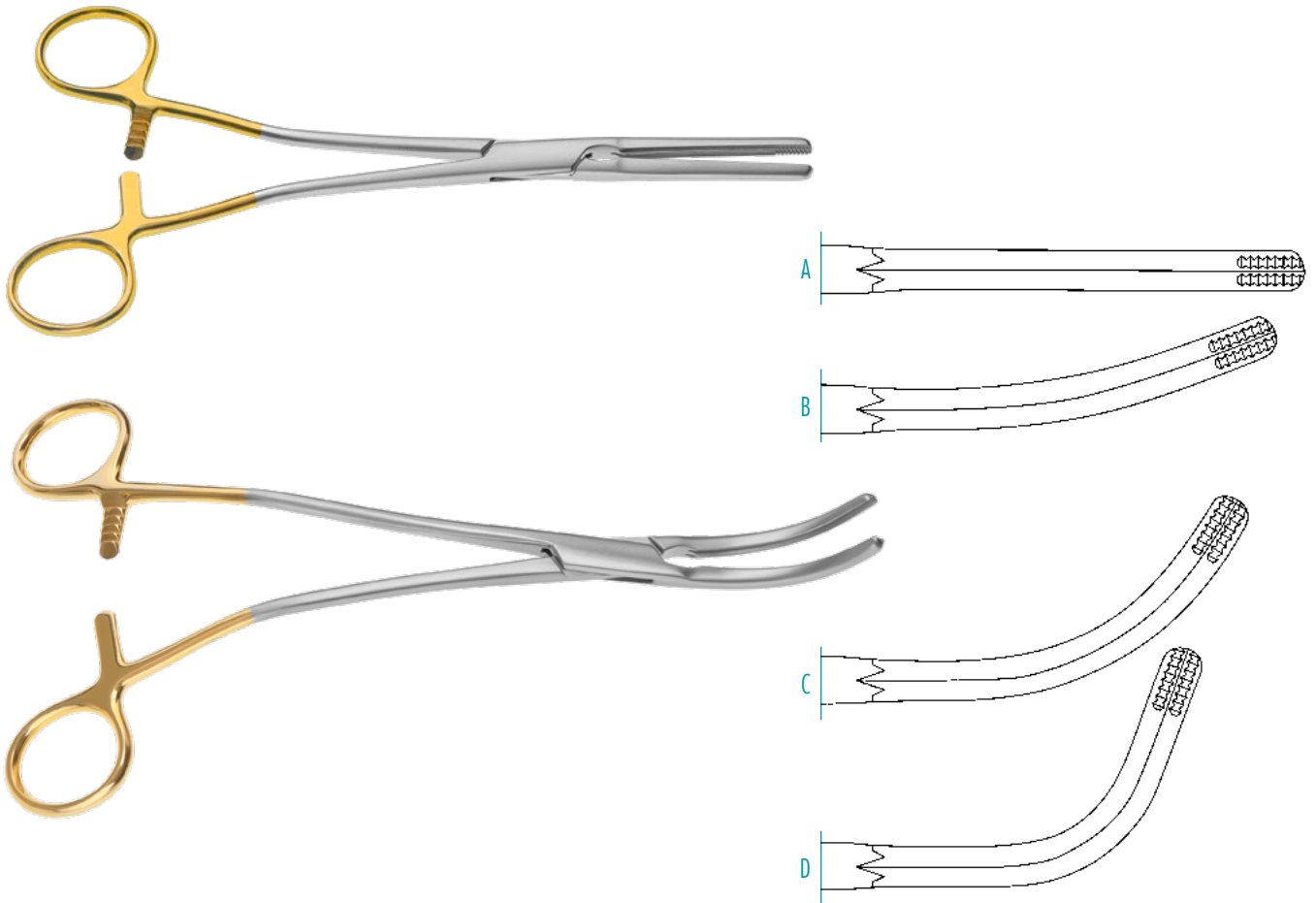

A Parametrium Forceps, straight

| | |
|--|-------------|
| 210mm, 8 ¹ / ₄ " | 140-700-220 |
| 250mm, 9 ⁷ / ₈ " | 140-700-250 |
| 305mm, 12" | 140-700-305 |
| 355mm, 14" | 140-700-350 |

B slightly curved

| | |
|--|-------------|
| 210mm, 8 ¹ / ₄ " | 140-701-215 |
| 240mm, 9 ¹ / ₂ " | 140-701-245 |
| 305mm, 12" | 140-701-305 |
| 355mm, 14" | 140-701-350 |

C strongly curved

| | |
|--|-------------|
| 210mm, 8 ¹ / ₄ " | 140-702-210 |
| 240mm, 9 ¹ / ₂ " | 140-702-245 |
| 305mm, 12" | 140-702-305 |
| 355mm, 14" | 140-702-350 |

D angled

| | |
|--|-------------|
| 210mm, 8 ¹ / ₄ " | 140-703-205 |
| 240mm, 9 ¹ / ₂ " | 140-703-245 |
| 305mm, 12" | 140-703-305 |
| 355mm, 14" | 140-703-350 |



A straight, angled shanks

| | |
|--|-------------|
| 210mm, 8 ¹ / ₄ " | 141-700-220 |
| 240mm, 9 ¹ / ₂ " | 141-700-250 |

B slightly curved, angled shanks

| | |
|--|-------------|
| 210mm, 8 ¹ / ₄ " | 141-701-215 |
| 240mm, 9 ¹ / ₂ " | 141-701-245 |

C strongly curved, angled shanks

| | |
|--|-------------|
| 210mm, 8 ¹ / ₄ " | 141-702-210 |
| 240mm, 9 ¹ / ₂ " | 141-702-245 |

D angled, angled shanks

| | |
|--|-------------|
| 210mm, 8 ¹ / ₄ " | 141-703-210 |
| 245mm, 9 ² / ₃ " | 141-703-245 |

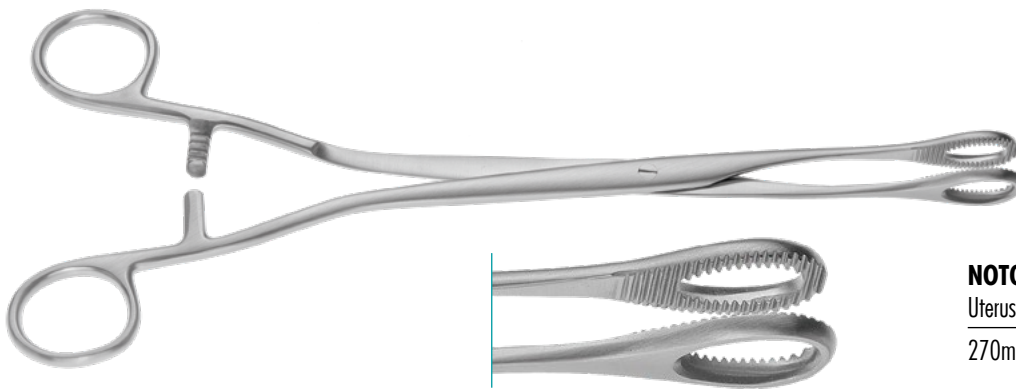

NOTO

Uterus Polypus Forceps

270mm, 10²/₃"

350-492-270

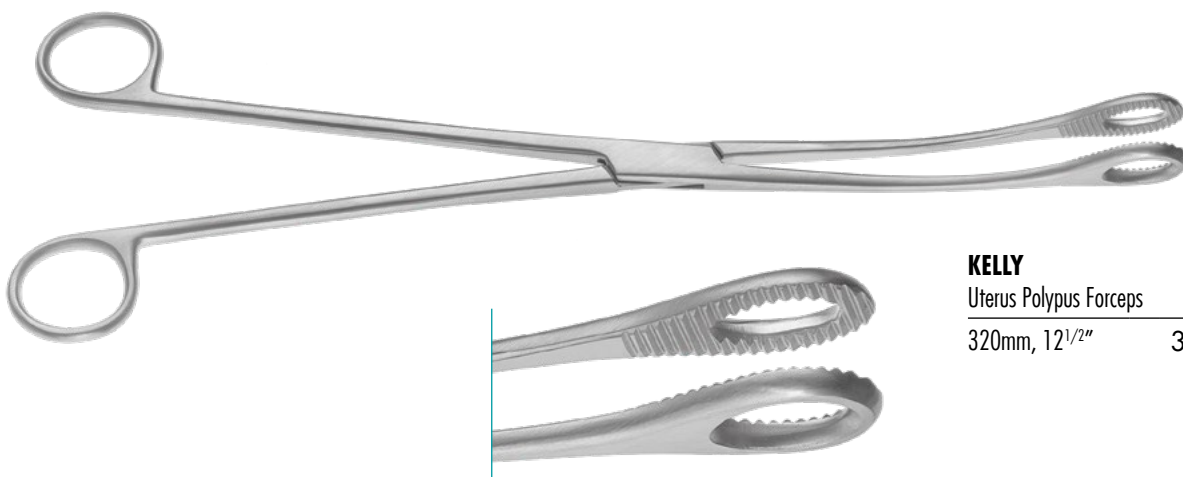

KELLY

Uterus Polypus Forceps

320mm, 12¹/₂"

350-490-320

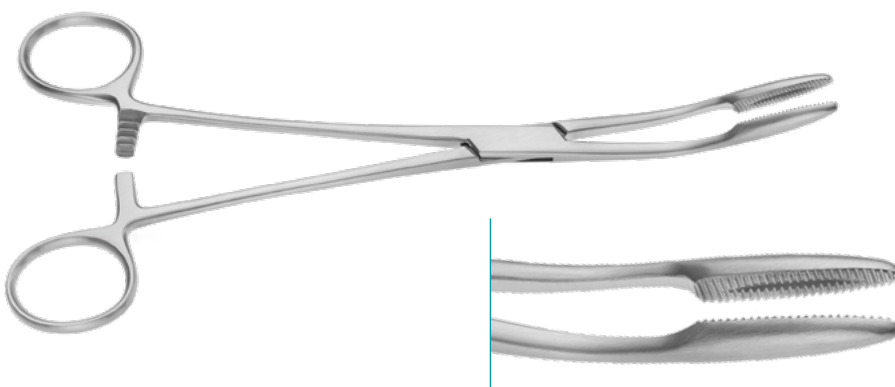

GROSS MAIER

Swab Forceps, curved

220mm, 8²/₃"

150-031-220

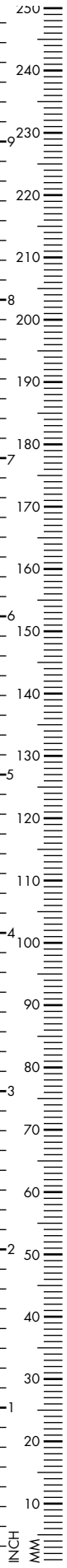

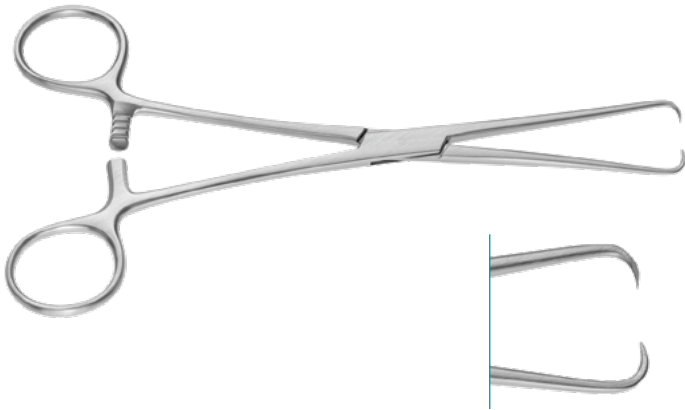

BARRETT

Tenaculum Forceps

180mm, 7"

350-426-180

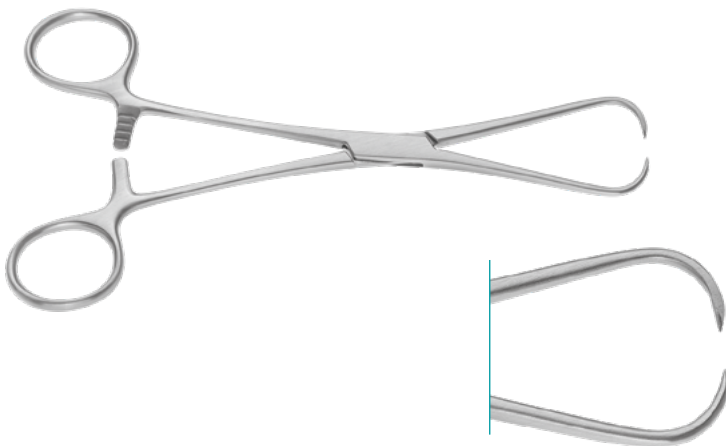

STAUDE MOORE

Tenaculum Forceps

170mm, 6²/₃"

350-422-170

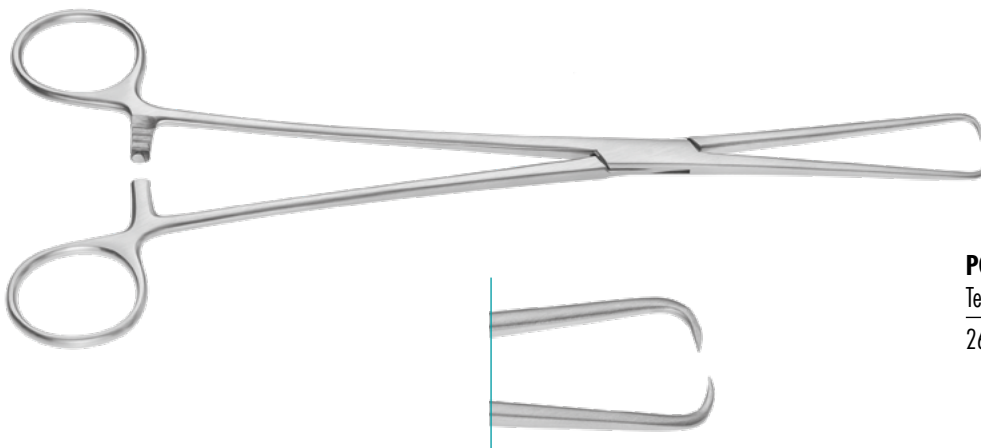

POZZI

Tenaculum Forceps

260mm, 10¹/₄"

350-420-260

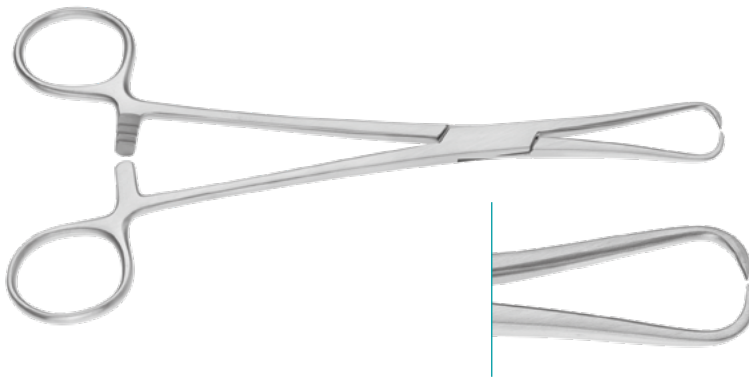
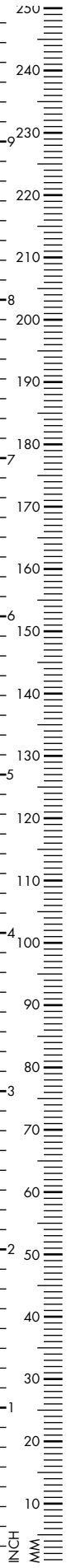

ADAIR

Tenaculum Forceps

190mm, 7^{1/2}"

350-426-190

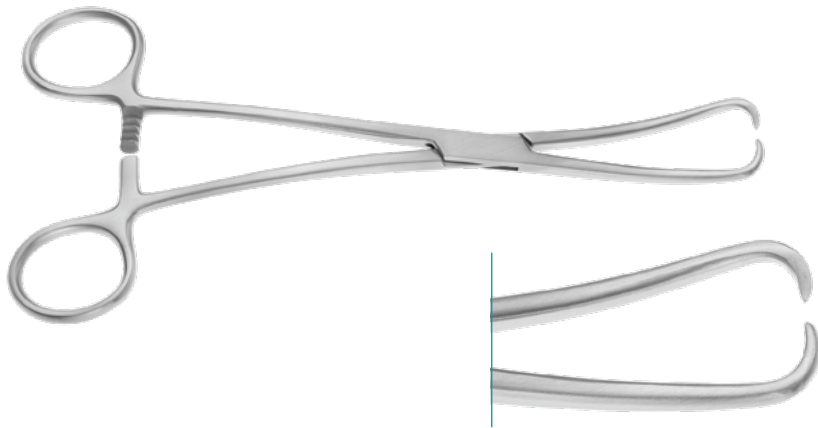

JARCHO

Tenaculum Forceps

200mm, 8"

350-427-200

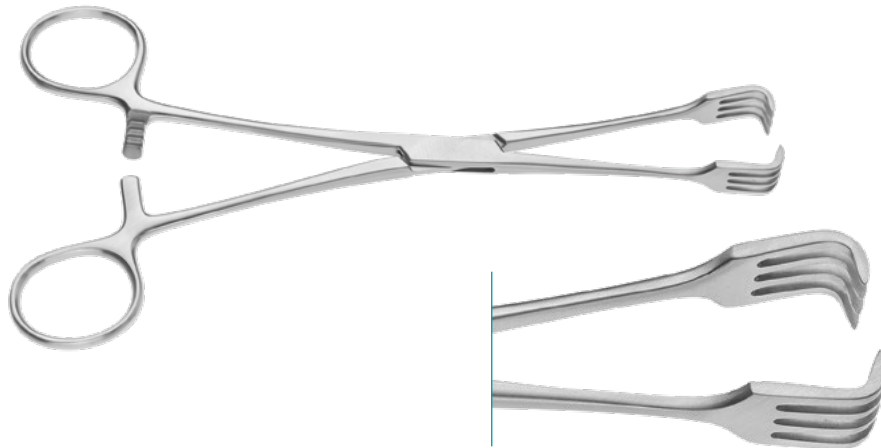

CZERNY

Tenaculum Forceps, straight

205mm, 8^{1/8}"

350-480-205

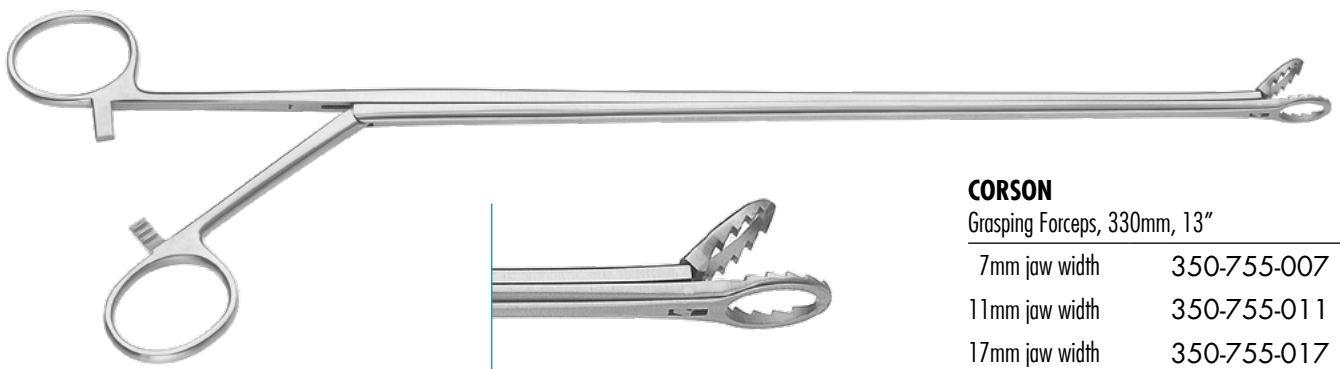

CORSON

Grasping Forceps, 330mm, 13"

7mm jaw width

350-755-007

11mm jaw width

350-755-011

17mm jaw width

350-755-017

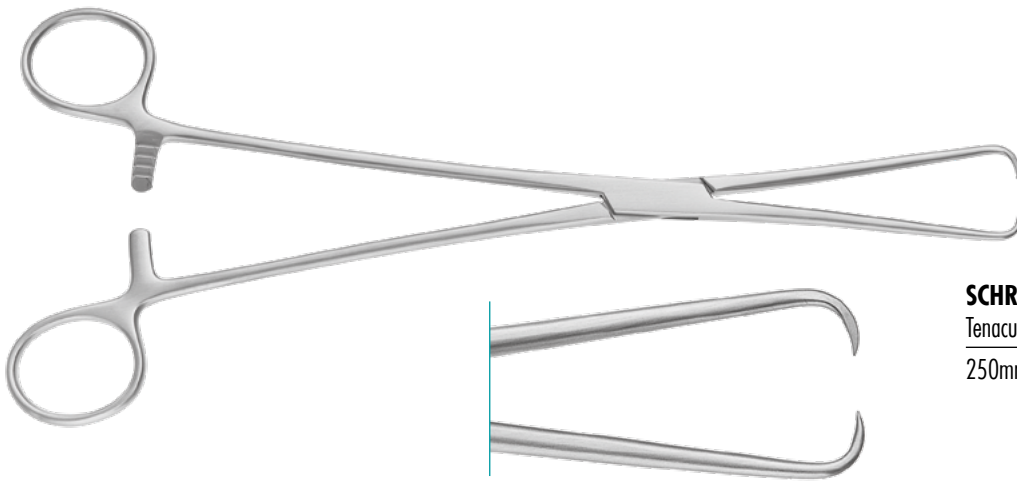

SCHROEDER

Tenaculum Forceps

250mm, 9⁷/₈"

350-400-250

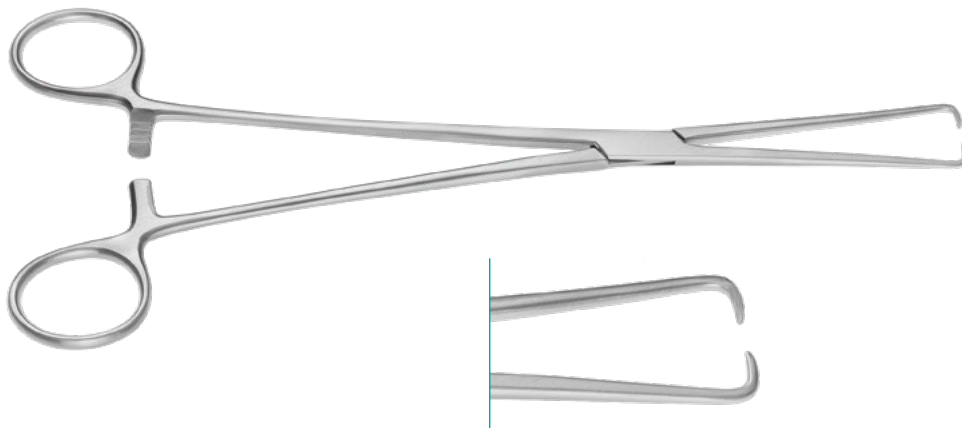

BRAUN

Tenaculum Forceps

250mm, 9⁷/₈"

350-410-250

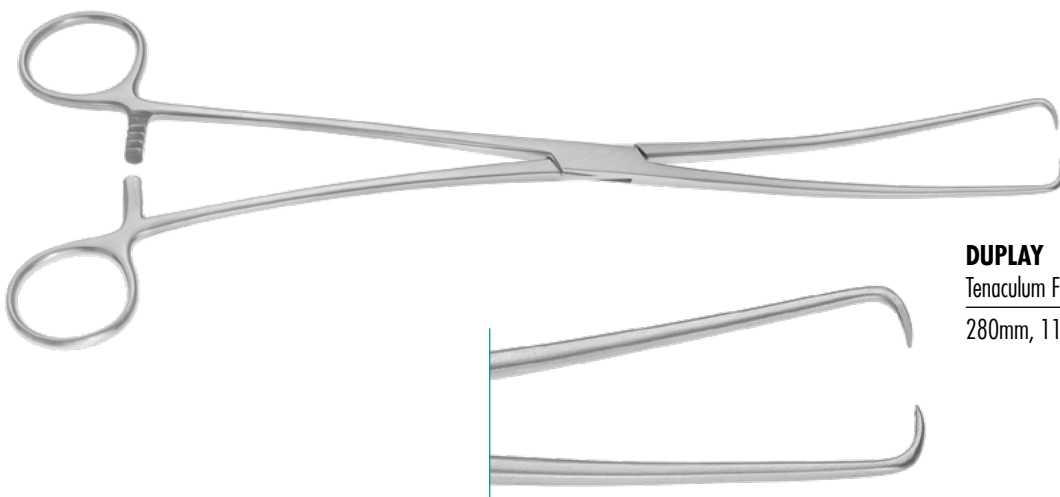

DUPLAY

Tenaculum Forceps

280mm, 11"

350-428-280

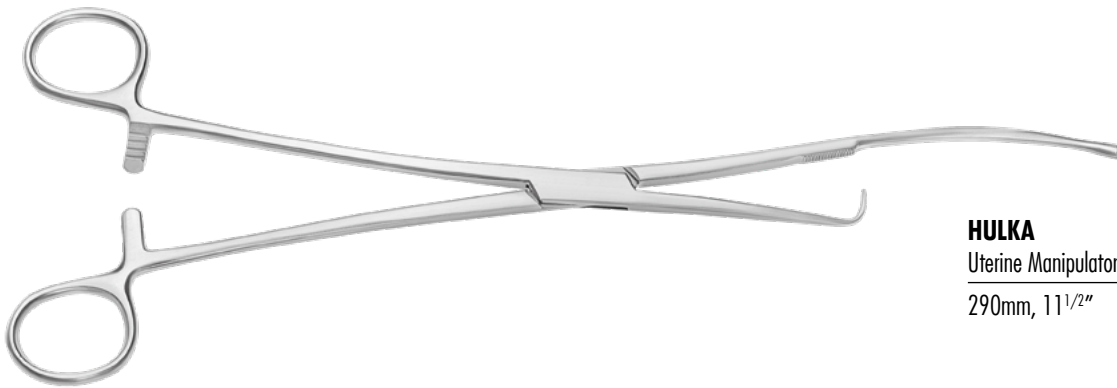

HULKA

Uterine Manipulator Tenaculum Forceps

290mm, 11¹/₂" 350-302-290

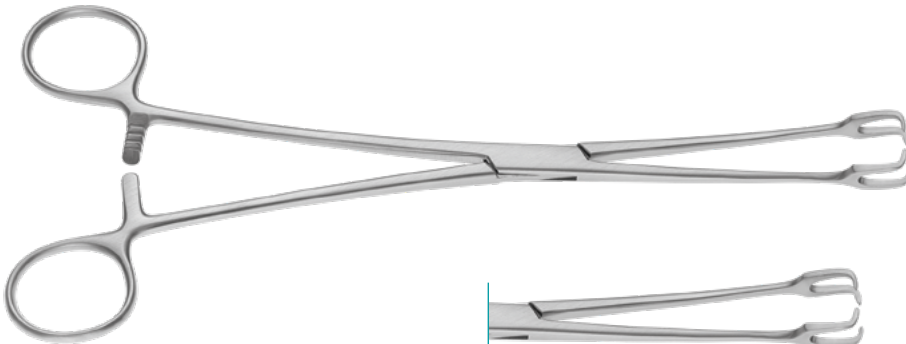

SCHROEDER

Tenaculum Forceps, 2 teeth, 240mm, 9¹/₂"

straight 350-440-240

curved 350-441-240

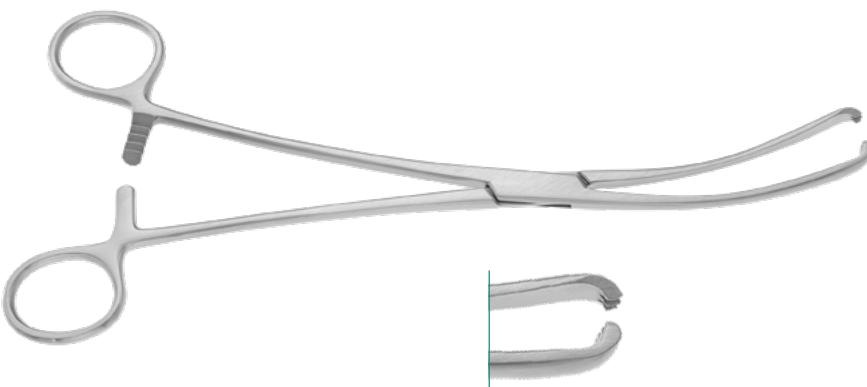

TEALE

Tenaculum Forceps, laterally curved, 3x4 teeth

230mm, 9" 350-443-230

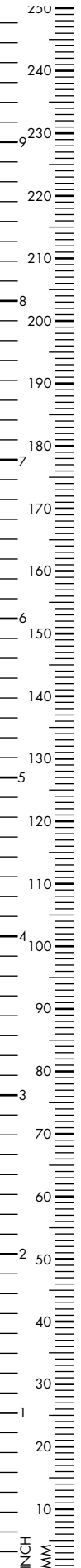

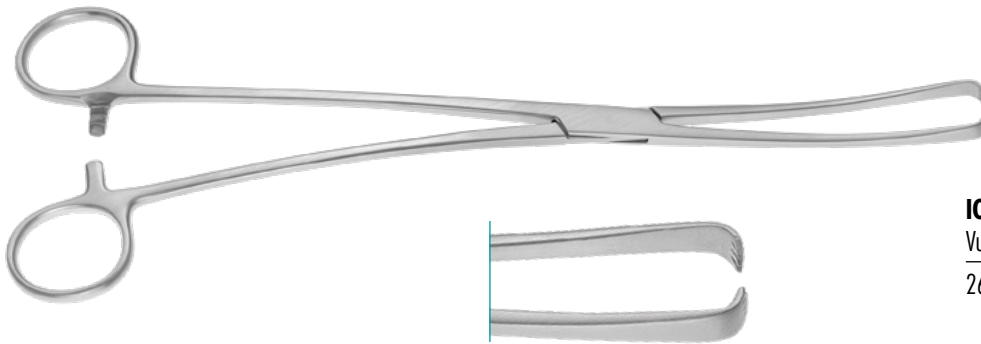

IOWA

Vulsellum Forceps

260mm, 10¹/₄"

350-445-260

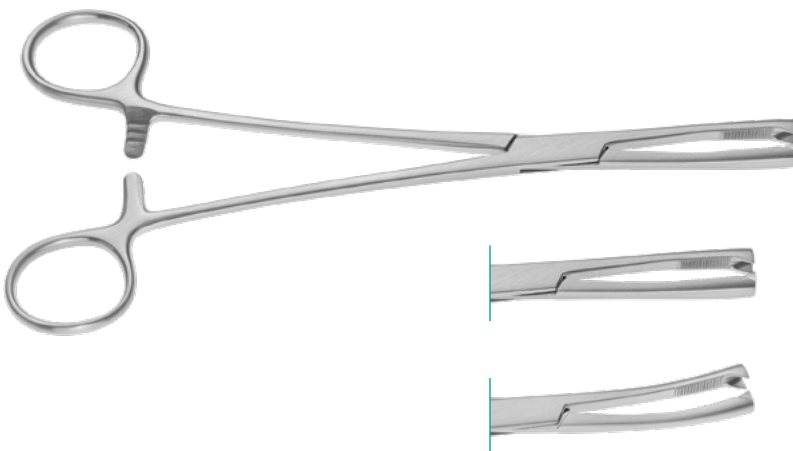

JACOBS

Tenaculum Forceps, 2x2 teeth, 210mm, 8¹/₄"

straight

350-470-210

curved

350-471-210

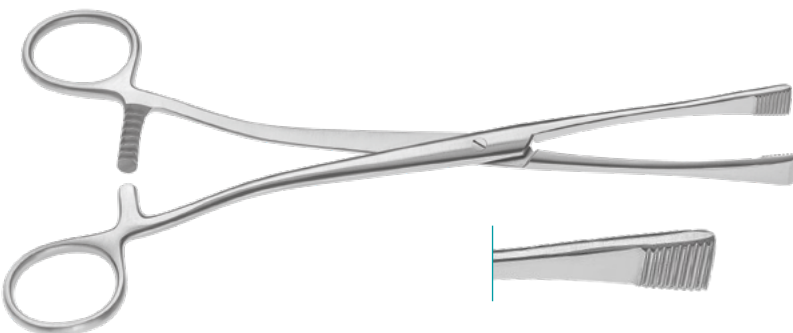

GREEN ARMYTAGE

Caesarean Forceps, straight,
15mm wide serrated jaw

210mm, 8¹/₄"

340-150-210

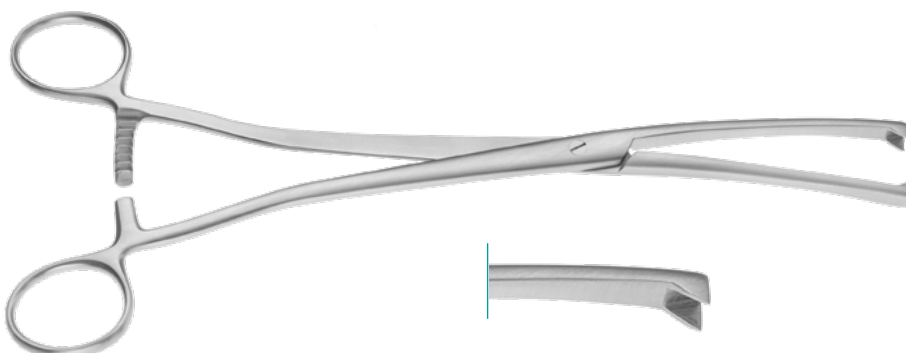

MUSEUX

Forceps, 2x2 teeth, 8mm jaw
240mm, 9¹/₂" working length

straight

350-452-240

curved

350-453-240

10mm jaw

straight

350-454-240

curved

350-455-240



DARTIGUES

Uterine Elevating Forceps

270mm, 10²/₃" 350-493-270

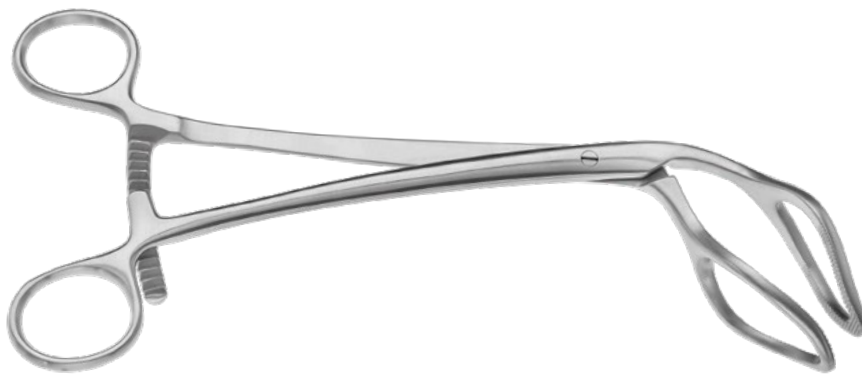

SOMER

Uterine Elevating Forceps

230mm, 9" 350-493-230

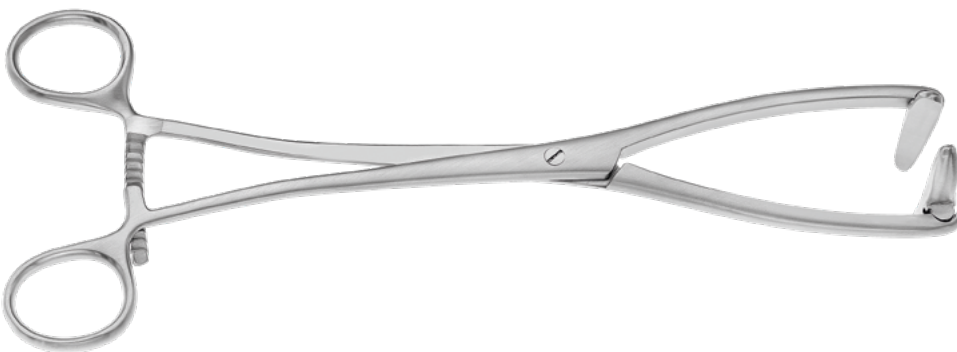

COLLIN

Uterine Forceps

250mm, 9⁷/₈" 350-493-250

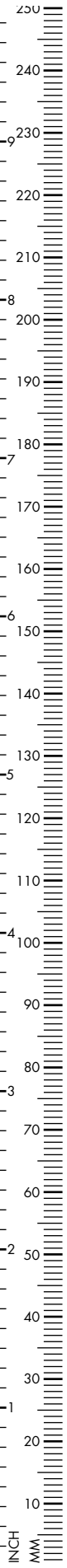

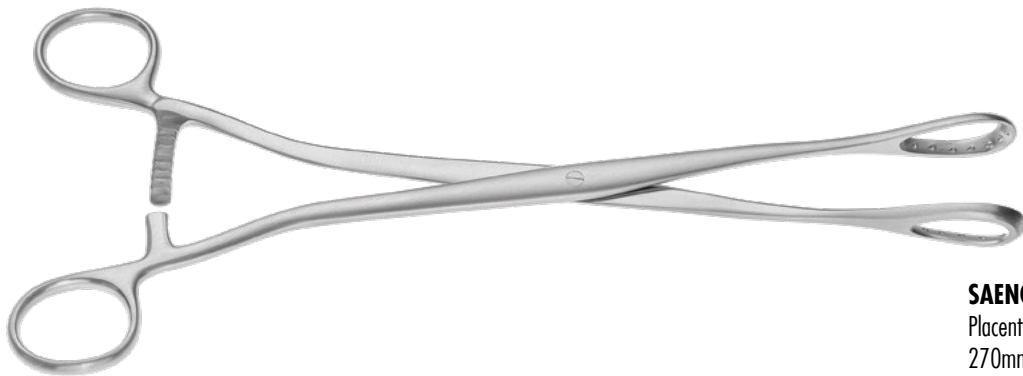

SAENGER

Placenta and Ovum Forceps,
270mm, 10²/₃"

| | |
|----------|-------------|
| straight | 340-798-270 |
| curved | 340-799-270 |

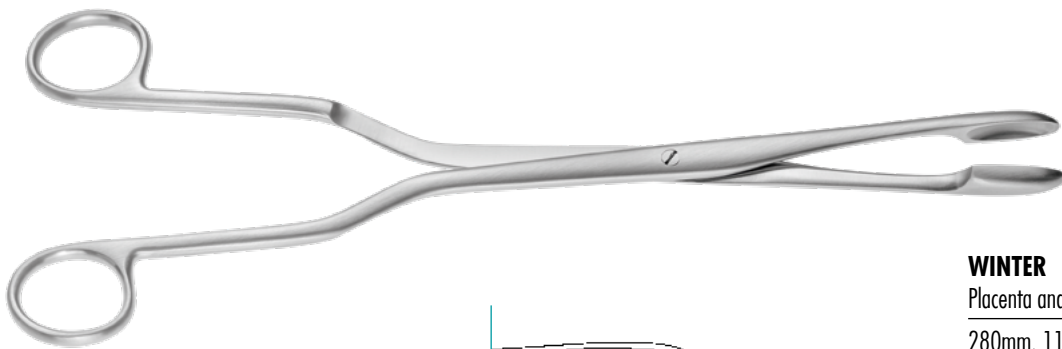

Fig. 1

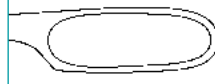
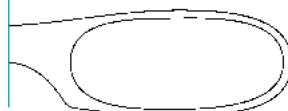

Fig. 2



WINTER

Placenta and Ovum Forceps, Fig. 2

| | |
|------------|-------------|
| 280mm, 11" | 340-799-280 |
|------------|-------------|

Placenta and Ovum Forceps, 280mm, 11"

| | |
|--------|-------------|
| Fig. 1 | 340-800-280 |
|--------|-------------|

| | |
|--------|-------------|
| Fig. 2 | 340-802-280 |
|--------|-------------|

Fig. 1 curved

| | |
|------------|-------------|
| 280mm, 11" | 340-801-280 |
|------------|-------------|



BIERER

Ovum Forceps, curved, 16mm jaw,
280mm, 11"

| | |
|-----------------|-------------|
| without ratchet | 350-496-330 |
|-----------------|-------------|

| | |
|--------------|-------------|
| with ratchet | 350-497-330 |
|--------------|-------------|



WRIGLEY

Obstetrical Forceps

280mm, 11"

340-011-280



SIMPSON

Obstetrical Forceps

300mm, 11^{7/8}"

340-013-300

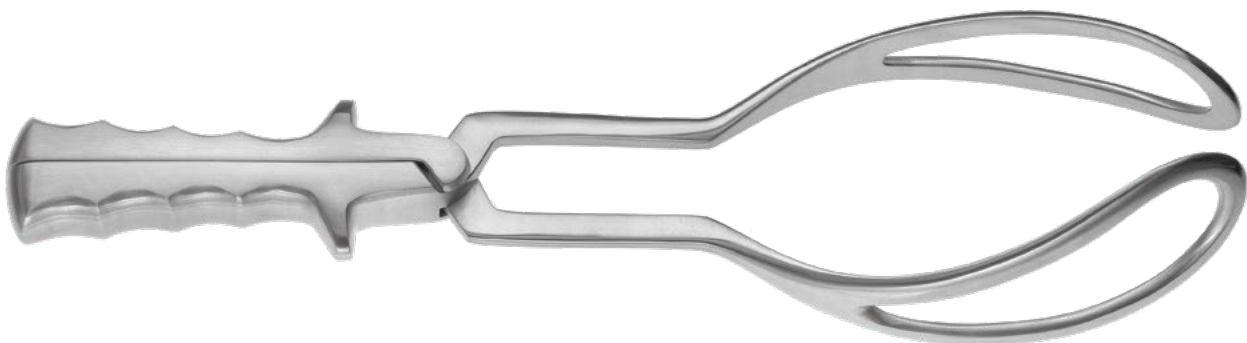

SIMPSON BRAUN

Obstetrical Forceps

330mm, 13"

340-012-330

360mm, 14"

340-012-360

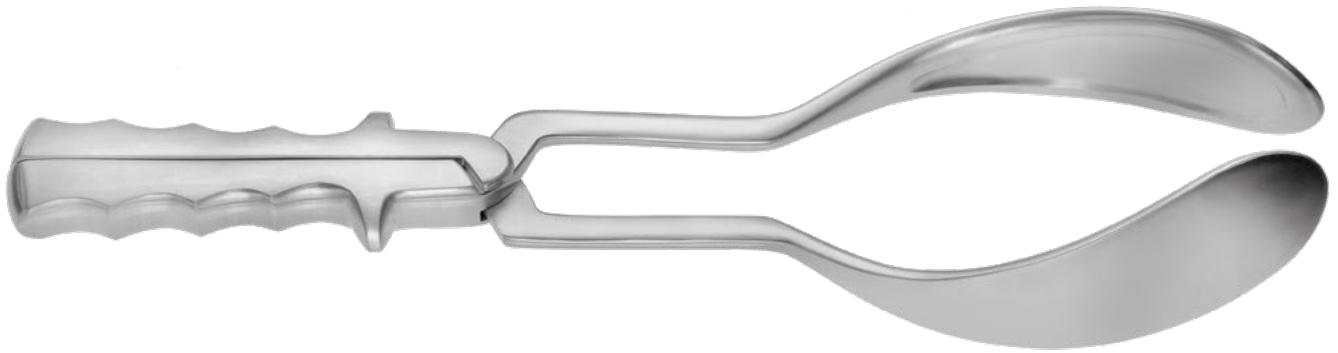
**SIMPSON LUIKART**

Obstetrical Forceps

360mm, 14"

340-029-360

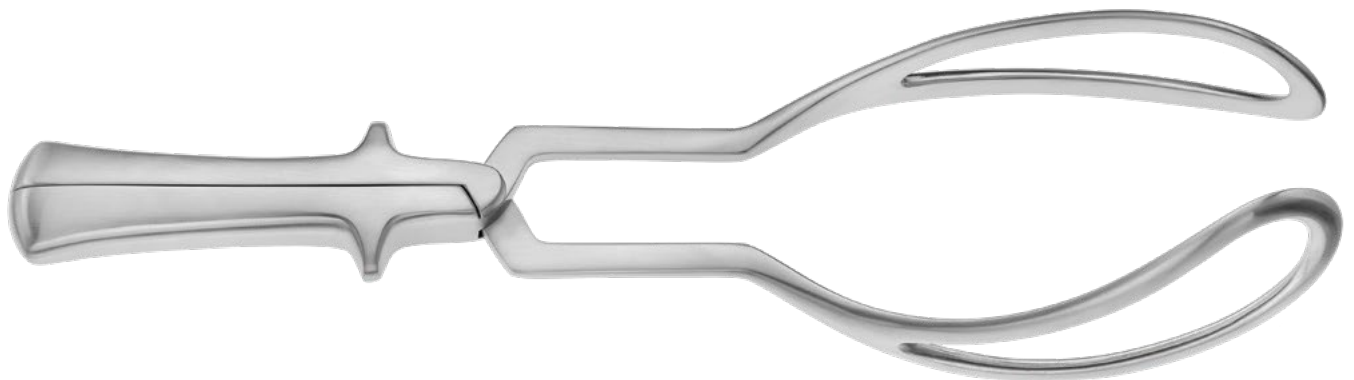
**DE LEE**

Obstetrical Forceps

300mm, 11⁷/₈"

340-018-300

360mm, 14"

340-018-360



ELLIOT
Obstetrical Forceps
380mm, 15" 340-025-380

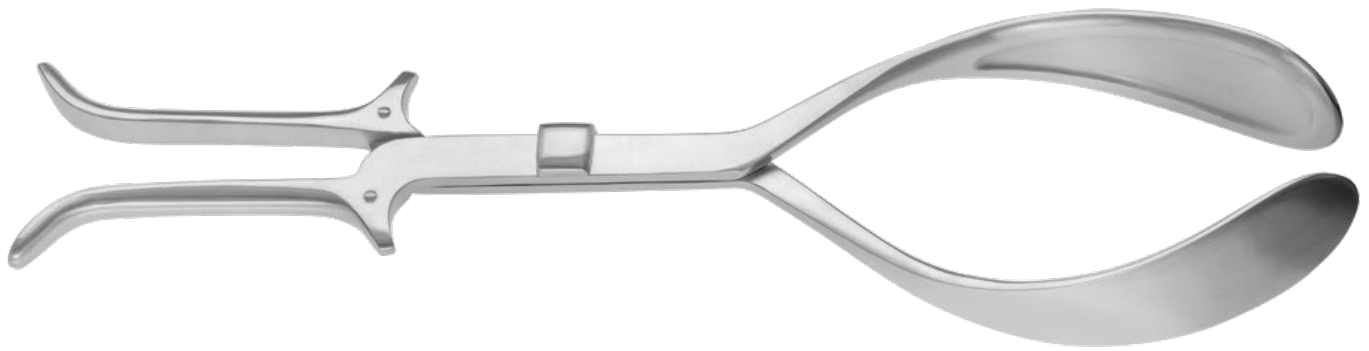

KIELLAND LIJKART
Obstetrical Forceps
400mm, 15^{3/4}" 340-016-400

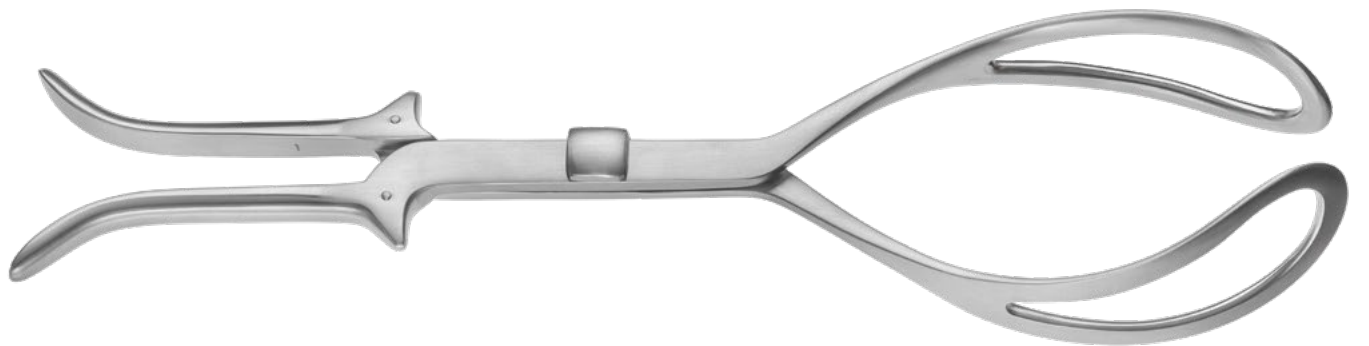

KIELLAND
Obstetrical Forceps
410mm, 16^{1/8}" 340-014-410

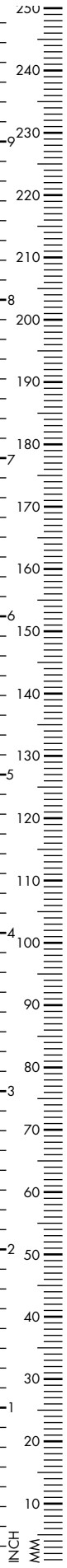

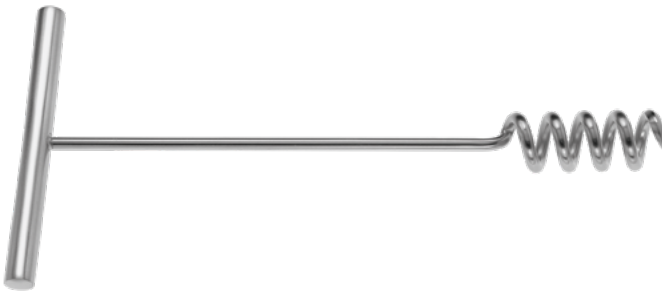

DOYEN

Myoma screw

170mm

working length

350-757-190

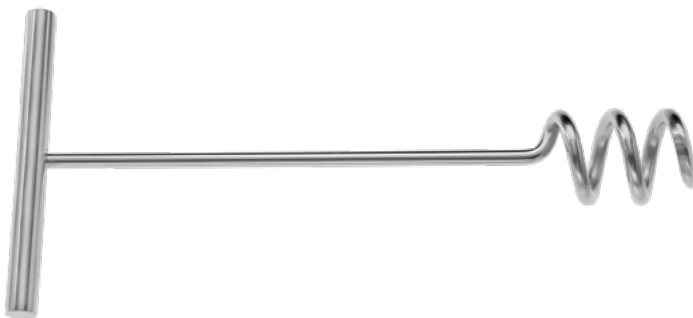

DOYEN

Myoma screw

170mm working
length

350-759-170

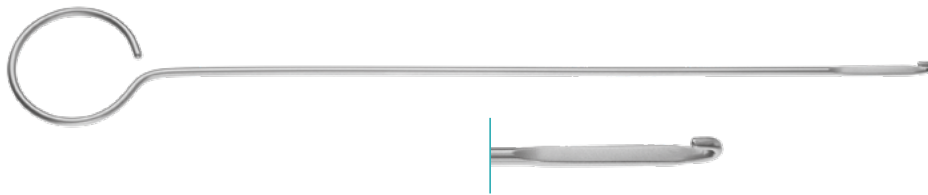

Simple IUD hook with ring handle, malleable
250mm, 9⁷/₈" 350-766-001

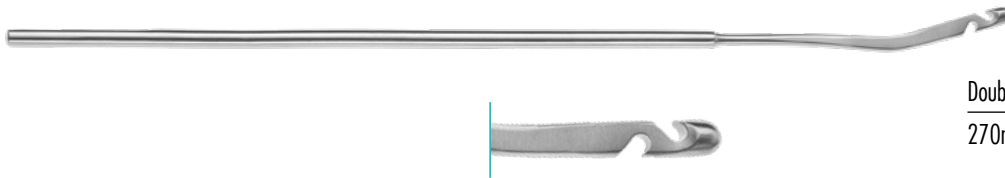

Double IUD Extractor
270mm, 10²/₃" 350-766-010



SAUNDERS
IUD Removing Hook
250mm, 9⁷/₈" 350-766-100



EMMET
Fistula Hook, 220mm, 8²/₃"
Fig. 1 350-765-001
Fig. 2 350-765-002
Fig. 3 350-765-003
Fig. 4 350-765-004
Fig. 5 350-765-005

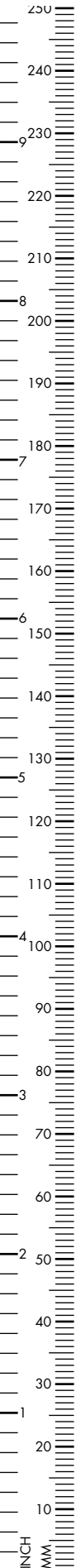
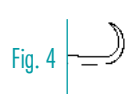

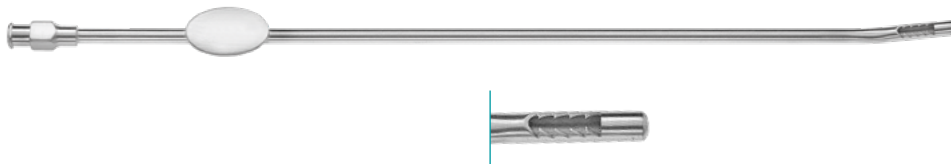

NOVAK

Biopsy Curette, 250mm, 9⁷/₈"

| | |
|-------|-------------|
| Ø 1mm | 350-601-230 |
| Ø 2mm | 350-602-230 |
| Ø 3mm | 350-603-230 |
| Ø 4mm | 350-604-230 |



A Aspirating Curette, 290mm, 11¹/₂"

| | |
|--------|-------------|
| 3.0mm | 350-650-030 |
| 4.5mm | 350-650-045 |
| 6.0mm | 350-650-060 |
| 8.0mm | 350-650-080 |
| 10.0mm | 350-650-100 |
| 12.0mm | 350-650-120 |
| 14.0mm | 350-650-140 |

B Coupling Piece

350-650-000

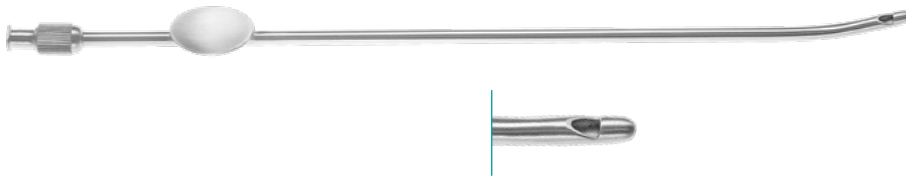

RANDALL

Suction Biopsy Curette, 240mm, 9¹/₂"

Ø 4mm

350-602-240

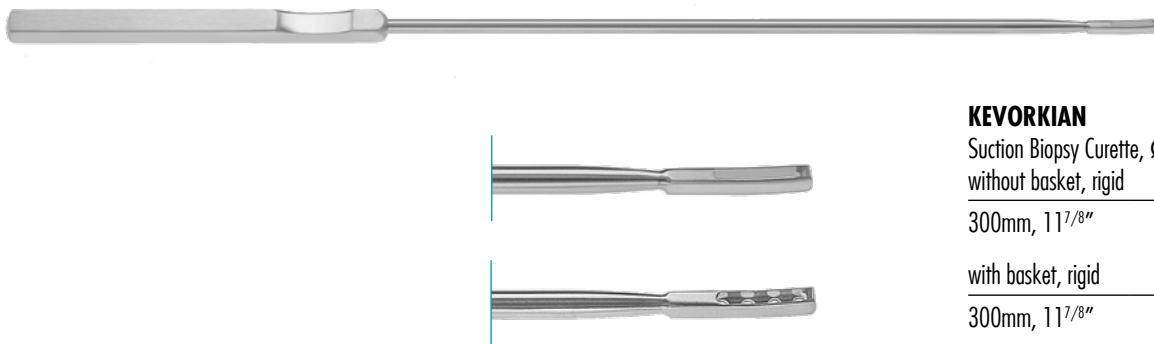

KEVORKIAN

Suction Biopsy Curette, Ø 4mm,
without basket, rigid

300mm, 11⁷/₈"

350-599-300

with basket, rigid

300mm, 11⁷/₈"

350-600-300

with basket, malleable

300mm, 11⁷/₈"

350-601-300

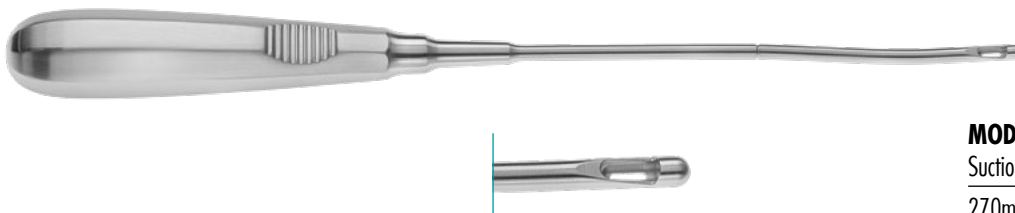

MOD. MÜNCHEN

Suction Biopsy Curette, Ø 4mm

270mm, 10²/₃"

350-605-270

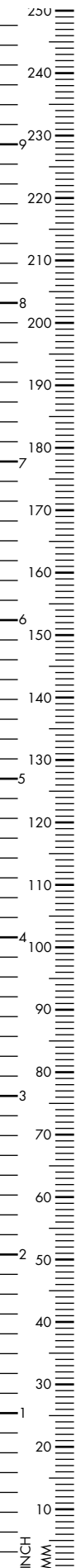

**BEACHAM**

Amniotome

260mm, 10¹/₄"

350-429-260

**BRAUN**

Uterine Depressor

280mm, 11"

350-399-280



Fig. 1



Fig. 2



Fig. 3

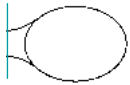

Fig. 4



Fig. 5

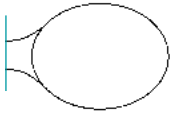

Fig. 6



SIMON

Uterine Scoop, sharp, 240mm, 9¹/₂"

| | |
|----------------|-------------|
| Fig. 1, 7.0mm | 350-610-001 |
| Fig. 2, 8.5mm | 350-610-002 |
| Fig. 3, 9.5mm | 350-610-003 |
| Fig. 4, 11.5mm | 350-610-004 |
| Fig. 5, 13.0mm | 350-610-005 |
| Fig. 6, 14.5mm | 350-610-006 |



Fig. 1

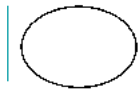

Fig. 2



Fig. 3

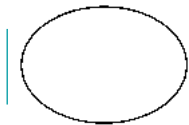

Fig. 4

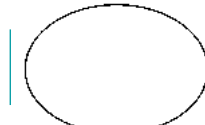

Fig. 5

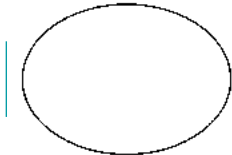

Fig. 6



SCHROEDER

Uterine Scoop, sharp, 300mm, 11⁷/₈"

| | |
|----------------|-------------|
| Fig. 1, 6.8mm | 350-612-001 |
| Fig. 2, 8.5mm | 350-612-002 |
| Fig. 3, 10.0mm | 350-612-003 |
| Fig. 4, 11.5mm | 350-612-004 |
| Fig. 5, 13.0mm | 350-612-005 |
| Fig. 6, 14.5mm | 350-612-006 |

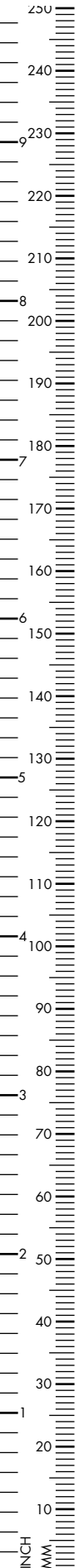

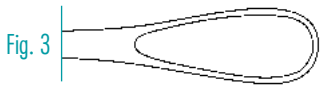
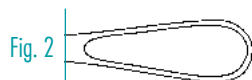
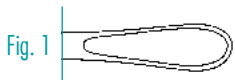

GOURDET

Uterine Scoop, blunt, 280mm, 11"

| | |
|--------------|-------------|
| Fig. 1, 6mm | 350-613-006 |
| Fig. 2, 8mm | 350-613-008 |
| Fig. 3, 10mm | 350-613-010 |
| Fig. 4, 12mm | 350-613-012 |
| Fig. 5, 14mm | 350-613-014 |



THOMAS

Uterus Curette, malleable, blunt, 280mm, 11"

| | |
|----------------|-------------|
| Fig. 1, Ø 10mm | 350-919-001 |
| Fig. 2, Ø 11mm | 350-919-002 |
| Fig. 3, Ø 12mm | 350-919-003 |
| Fig. 4, Ø 13mm | 350-919-004 |
| Fig. 5, Ø 14mm | 350-919-005 |
| Fig. 6, Ø 15mm | 350-919-006 |



SIMS

Uterus Curette, 285mm, 11^{1/4}"

rigid, sharp

rigid, blunt

malleable, sharp

malleable, blunt



Fig. 00, 5mm



Fig. 0, 6mm



Fig. 1, 7mm



Fig. 2, 8mm

350-630-005

350-630-006

350-630-007

350-630-008

350-926-050

350-926-060

350-926-070

350-926-080

350-631-005

350-631-006

350-631-007

350-631-008

350-927-050

350-927-060

350-927-070

350-927-080



Fig. 3, 9mm



Fig. 4, 11mm



Fig. 5, 12mm

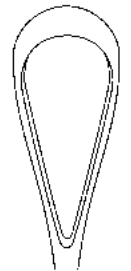

Fig. 6, 14mm

rigid, sharp

rigid, blunt

malleable, sharp

malleable, blunt

350-630-009

350-630-011

350-630-012

350-630-014

350-926-090

350-926-110

350-926-120

350-926-140

350-631-009

350-631-011

350-631-012

350-631-014

350-927-090

350-927-110

350-927-120

350-927-140



Fig. 7, 15mm



Fig. 8, 16mm

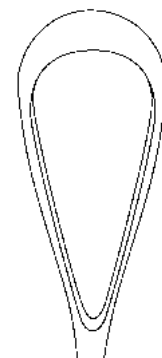

Fig. 9, 19mm

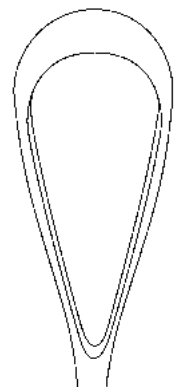

Fig. 10, 20mm

rigid, sharp

rigid, blunt

malleable, sharp

malleable, blunt

350-630-015

350-630-016

350-630-019

350-630-020

350-926-150

350-926-160

350-926-190

350-926-200

350-631-015

350-631-016

350-631-019

350-631-020

350-927-150

350-927-160

350-927-190

350-927-200



RECAMIER

Uterus Curette, 310mm, 12^{1/4}"

rigid, sharp

rigid, blunt

malleable, sharp

malleable, blunt



Fig. 00, 5mm

350-620-005



Fig. 0, 6mm

350-620-006



Fig. 1, 7mm

350-620-007



Fig. 2, 8mm

350-620-008



Fig. 3, 9mm

350-620-009



Fig. 4, 11mm

350-620-011



Fig. 5, 12mm

350-620-012

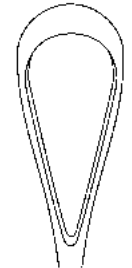

Fig. 6, 14mm

350-620-014

rigid, sharp

rigid, blunt

malleable, sharp

malleable, blunt

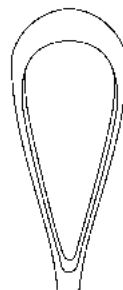

Fig. 7, 15mm

350-620-015



Fig. 8, 16mm

350-620-016

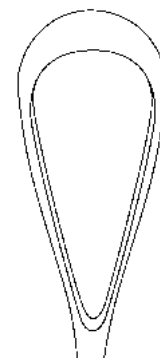

Fig. 9, 19mm

350-620-019

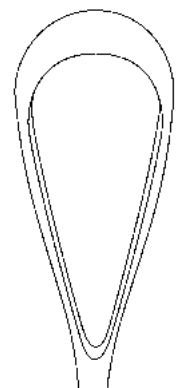

Fig. 10, 20mm

350-620-020

rigid, sharp

rigid, blunt

malleable, sharp

malleable, blunt

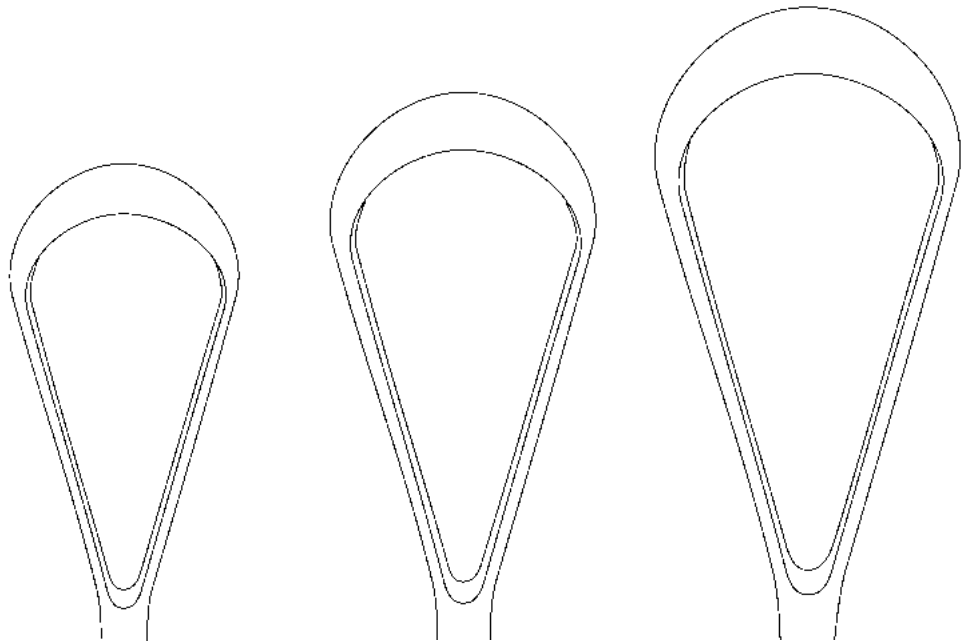

BUMM

Uterus Curette, 300mm, 11^{7/8}"

Fig. 1, 30mm

Fig. 2, 35mm

Fig. 3, 40mm

rigid, sharp

350-920-300

350-920-350

350-920-400

rigid, blunt

350-926-300

350-926-350

350-926-400

malleable, sharp

350-928-300

350-928-350

350-928-400

malleable, blunt

350-929-300

350-929-350

350-929-400

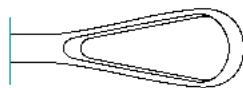
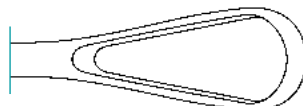

BLAKE

Biopsy Curette, sharp/blunt

270mm, 10^{2/3}"

350-614-270

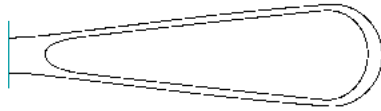

WALLICH

Placenta / Ovum Scoop

420mm, 16¹/₂"

340-510-420

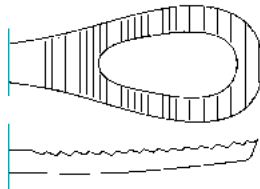

PESTALOZZA

Uterus Curette

300mm, 11⁷/₈"

340-500-300



GREENE

Uterus Curette, 280mm, 11"

10mm

350-365-010

12mm

350-365-012

14mm

350-365-014



MILAN

Curette

290mm, 11¹/₂"

350-605-007



FAURE

Biopsy Forceps

210mm, 8¹/₄"

350-843-210



SCHUBERT

Biopsy Forceps

210mm, 8¹/₄"

350-844-210

290mm, 11¹/₂"

350-844-290

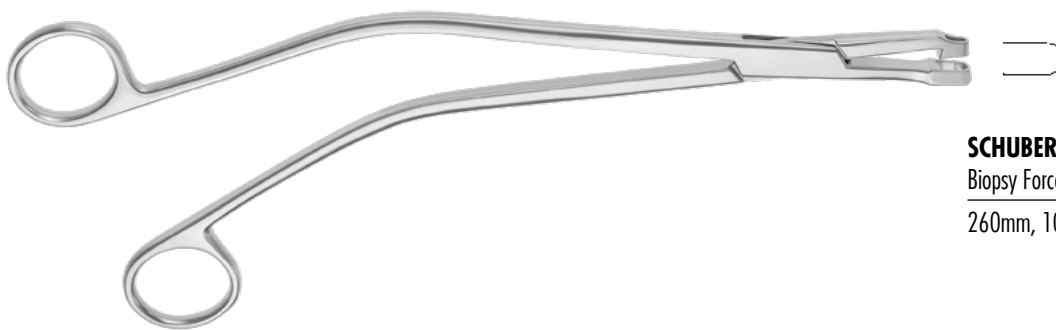

SCHUBERT

Biopsy Forceps

260mm, 10¹/₄"

350-847-260

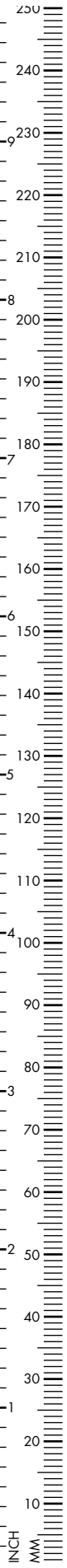

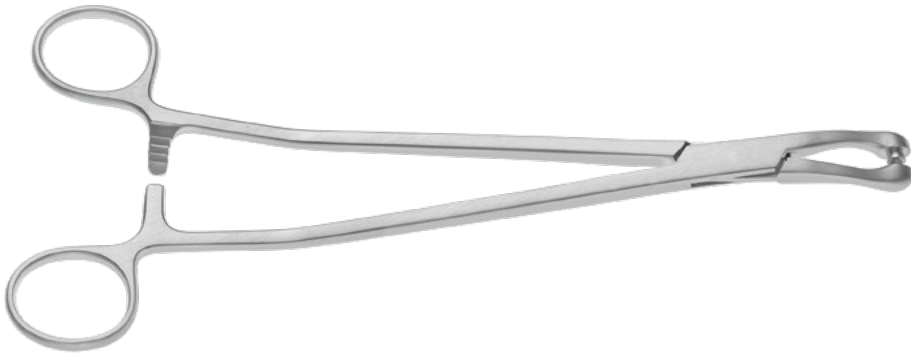

THOMS GAYLOR

Biopsy Forceps, curved

220mm, 8²/₃" 350-857-220

240mm, 9¹/₂" 350-857-240

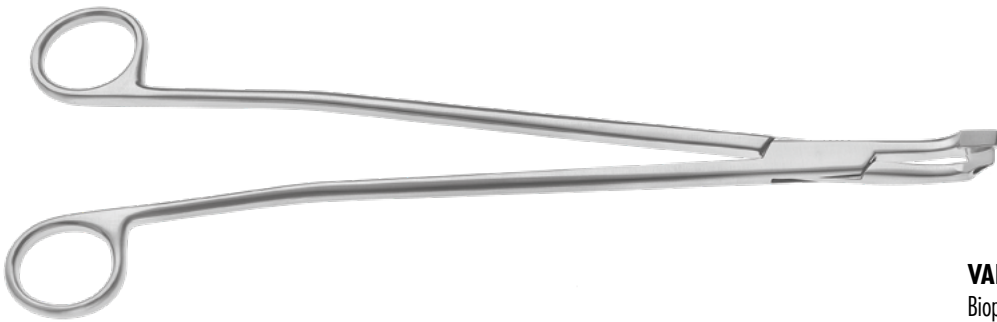

VAN DOREN

Biopsy Forceps

267mm, 10¹/₂" 350-855-267

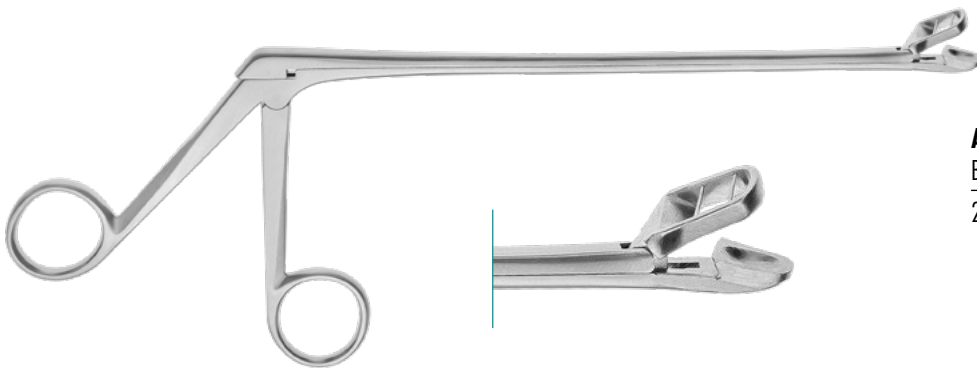

ALEXANDER

Biopsy Forceps

280mm, 11" 310-735-280

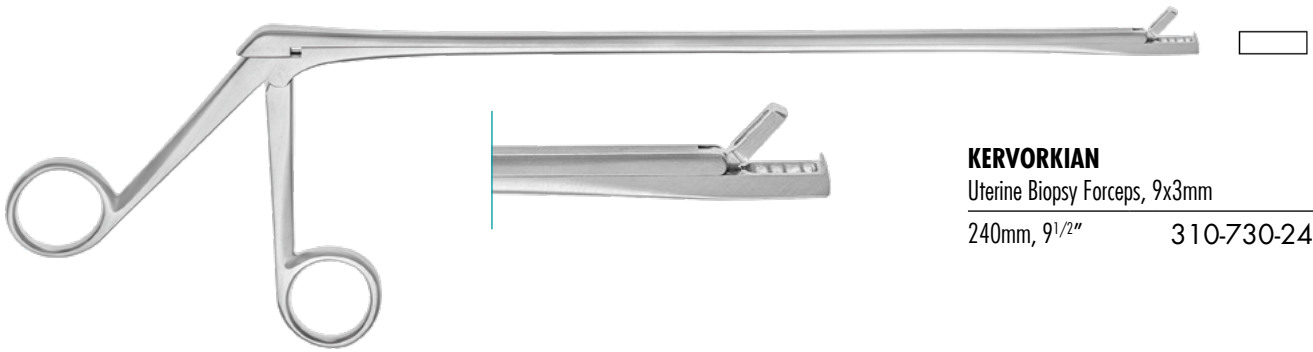

KERVORKIAN

Uterine Biopsy Forceps, 9x3mm

240mm, 9¹/₂" 310-730-240

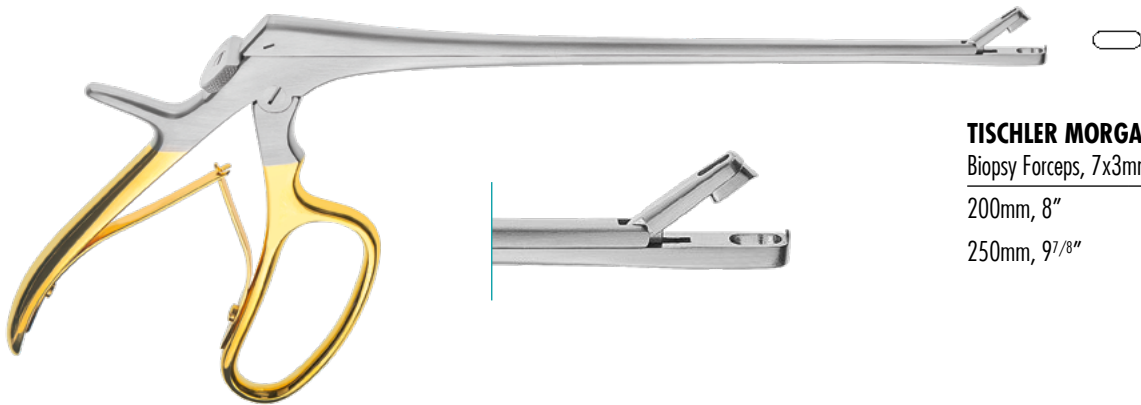

TISCHLER MORGAN

Biopsy Forceps, 7x3mm

200mm, 8" 310-733-001

250mm, 9⁷/₈" 310-735-001

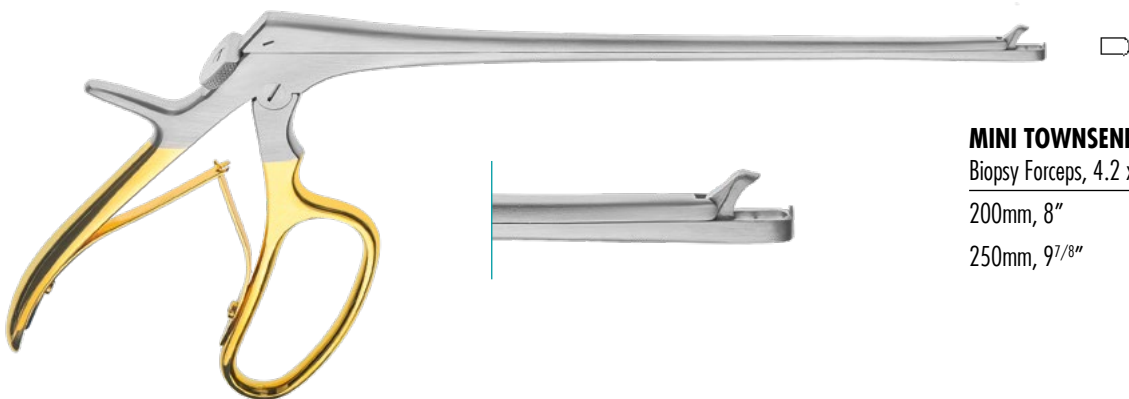

MINI TOWNSEND

Biopsy Forceps, 4.2 x 2.3mm jaw

200mm, 8" 310-733-002

250mm, 9⁷/₈" 310-735-002

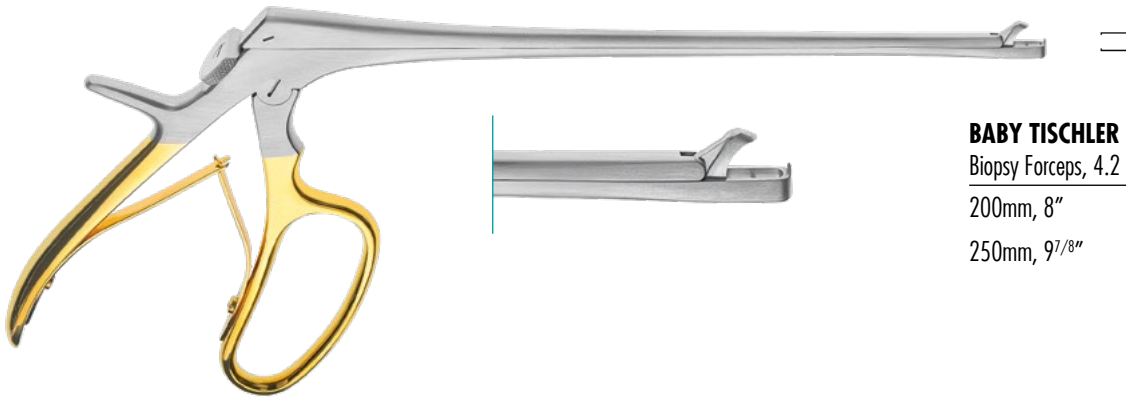

BABY TISCHLER

Biopsy Forceps, 4.2 x 2.3mm jaw

200mm, 8" 310-733-003

250mm, 9⁷/₈" 310-735-003

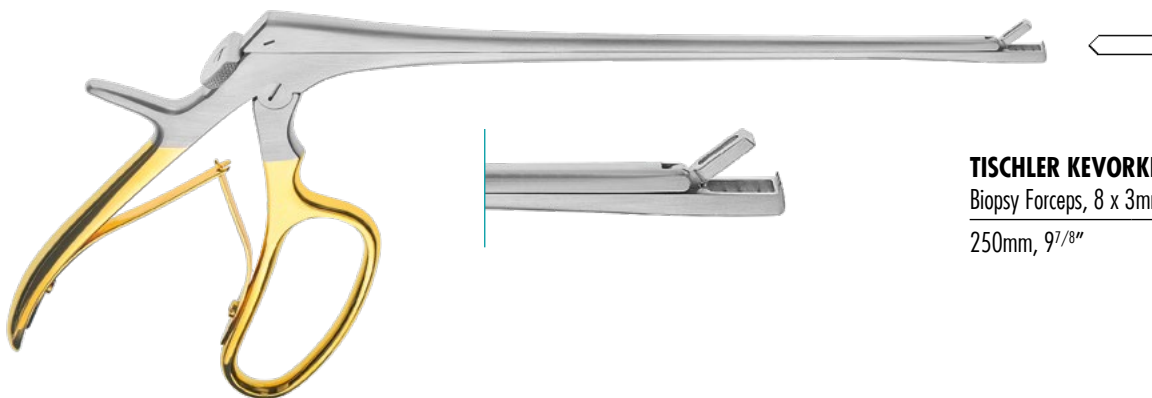

TISCHLER KEVORKIAN

Biopsy Forceps, 8 x 3mm jaw

250mm, 9⁷/₈" 310-731-250

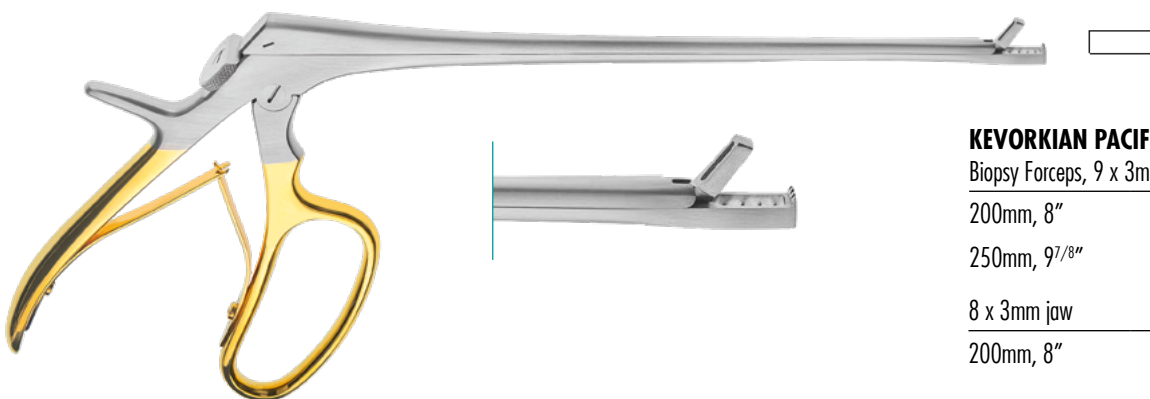

KEVORKIAN PACIFIC

Biopsy Forceps, 9 x 3mm jaw

200mm, 8" 310-732-200

250mm, 9⁷/₈" 310-732-250

8 x 3mm jaw

200mm, 8" 310-731-200



Detachable Biopsy Forceps "Roto Fit"



UNI TISCHLER

Insert only, 3 x 7mm, 230mm, 9"

| | |
|---------------|-------------|
| A straight | 310-800-100 |
| B angled up | 310-801-100 |
| C angled down | 310-802-100 |

complete instrument with handle

| | |
|---------------|-------------|
| A straight | 310-800-000 |
| B angled up | 310-801-000 |
| C angled down | 310-802-000 |

UNI TOWNSEND

Insert only, 2.3 x 7mm, 230mm, 9"

| | |
|---------------|-------------|
| D straight | 310-803-100 |
| E angled up | 310-804-100 |
| F angled down | 310-805-100 |

complete instrument with handle

| | |
|---------------|-------------|
| D straight | 310-803-000 |
| E angled up | 310-804-000 |
| F angled down | 310-805-000 |

UNI KERVOKIAN

Insert only, 3 x 9mm, 230mm, 9"

| | |
|------------|-------------|
| G straight | 310-806-100 |
|------------|-------------|

complete instrument with handle

| | |
|------------|-------------|
| G straight | 310-806-000 |
|------------|-------------|

UNI OVAL

Insert only, 3 x 5.5mm, 230mm, 9"

| | |
|------------|-------------|
| H straight | 310-807-100 |
|------------|-------------|

complete instrument with handle

| | |
|------------|-------------|
| H straight | 310-807-000 |
|------------|-------------|

I Handle only

310-800-600

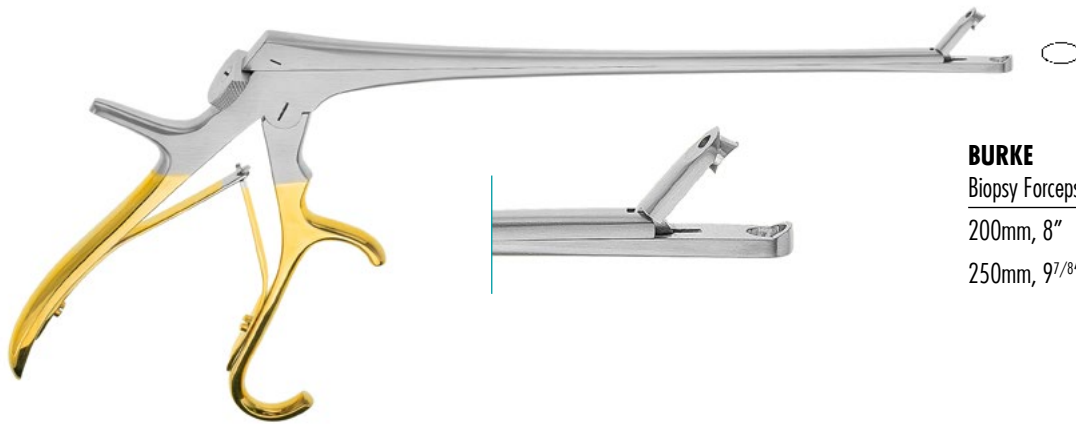

BURKE

Biopsy Forceps, 5 x 3mm jaw

| | |
|---------------------------|-------------|
| 200mm, 8" | 310-732-000 |
| 250mm, 9 ^{7/8} " | 310-735-004 |

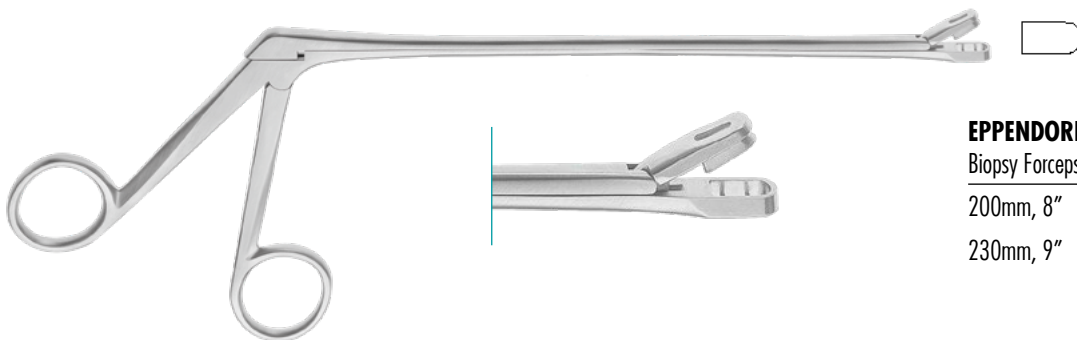

EPPENDORFER

Biopsy Forceps, 4x8mm

| | |
|-----------|-------------|
| 200mm, 8" | 310-760-200 |
| 230mm, 9" | 310-760-230 |

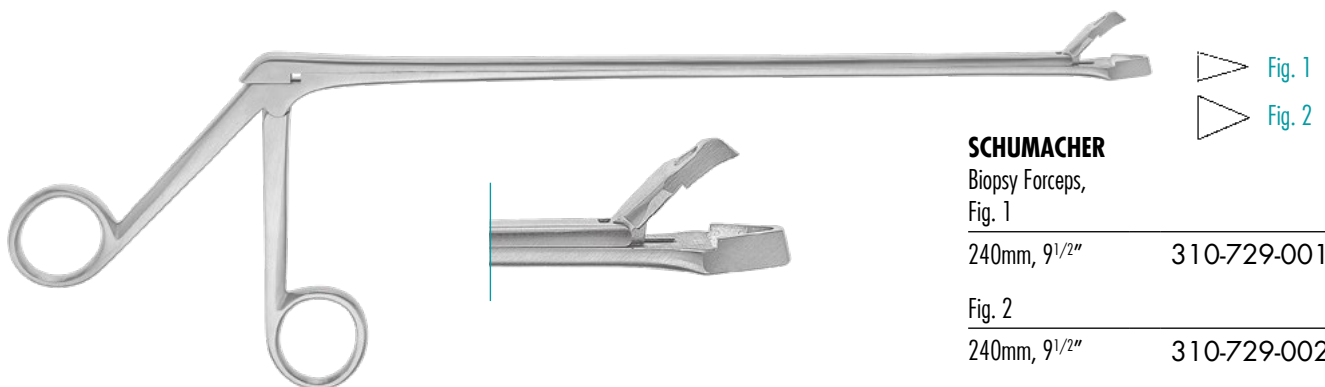

SCHUMACHER

Biopsy Forceps,
Fig. 1

| | |
|---------------------------|-------------|
| 240mm, 9 ^{1/2} " | 310-729-001 |
|---------------------------|-------------|

Fig. 2

| | |
|---------------------------|-------------|
| 240mm, 9 ^{1/2} " | 310-729-002 |
|---------------------------|-------------|

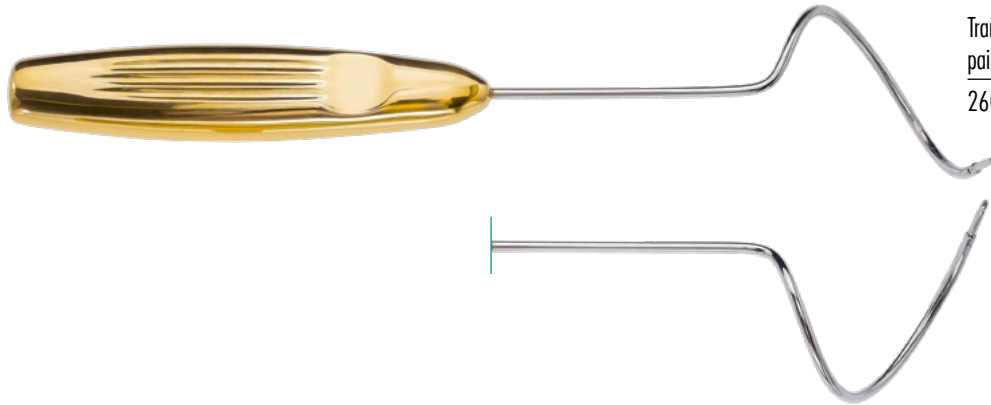

Transobturator Sling needle
pair of right and left curved

260mm, 10¹/₄" 350-101-260



MIYAZAKI

Ligature Carrier, large hook 0.75"

200mm, 8" shaft 180-160-000



MIYAZAKI

Speculum with notch

180-160-010



SIMS

Uterine Probe, graduated, Ø 4mm,
330mm, 13"

rigid 350-395-320

malleable 350-396-320



SIMPSON

Uterine Probe, malleable, Ø 4mm

290mm, 11¹/₂" 350-396-290

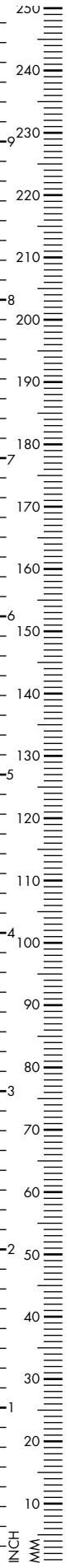



Uterine manipulator, complete set
(350-660-111 - 350-660-116)

350-660-100



Adaptor \varnothing 8 x 80 mm

350-660-111



Adaptor \varnothing 10 x 100 mm

350-660-112



Adaptor \varnothing 3 x 45 mm

350-660-113



Adaptor \varnothing 3 x 55 mm

350-660-114



Adaptor \varnothing 3.2 x 35 mm

350-660-115



Adaptor \varnothing 3.2 x 45 mm

350-660-116



COHEN

Uterus Cannula
complete with 2 interchangeable acorns

350-750-000

Acorns

small 350-750-001

large 350-750-002

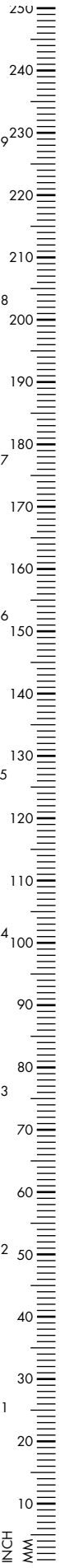

HEGAR

Uterine Dilator, double-ended

| | | | |
|-------------|-------------|-------------|-------------|
| 1.0/2.0mm | 350-382-020 | 15.0/16.0mm | 350-382-160 |
| 3.0/4.0mm | 350-382-040 | 17.0/18.0mm | 350-382-180 |
| 5.0/6.0mm | 350-382-060 | 19.0/20.0mm | 350-382-200 |
| 7.0/8.0mm | 350-382-080 | 21.0/22.0mm | 350-382-220 |
| 9.0/10.0mm | 350-382-100 | 23.0/24.0mm | 350-382-240 |
| 11.0/12.0mm | 350-382-120 | 25.0/26.0mm | 350-382-260 |
| 13.0/14.0mm | 350-382-140 | | |

Set*, 8 sizes from 3/4 to 17/18 mm
in canvas roll

350-383-001



HEGAR

Uterine Dilator with slope handle

| | | | | | |
|--------|-------------|--------|-------------|--------|-------------|
| 1.0mm | 350-380-010 | 12.5mm | 350-380-125 | 24.0mm | 350-380-240 |
| 1.5mm | 350-380-015 | 13.0mm | 350-380-130 | 25.0mm | 350-380-250 |
| 2.0mm | 350-380-020 | 13.5mm | 350-380-135 | 26.0mm | 350-380-260 |
| 2.5mm | 350-380-025 | 14.0mm | 350-380-140 | 27.0mm | 350-380-270 |
| 3.0mm | 350-380-030 | 14.5mm | 350-380-145 | 28.0mm | 350-380-280 |
| 3.5mm | 350-380-035 | 15.0mm | 350-380-150 | 29.0mm | 350-380-290 |
| 4.0mm | 350-380-040 | 15.5mm | 350-380-155 | 30.0mm | 350-380-300 |
| 4.5mm | 350-380-045 | 16.0mm | 350-380-160 | | |
| 5.0mm | 350-380-050 | 16.5mm | 350-380-165 | | |
| 5.5mm | 350-380-055 | 17.0mm | 350-380-170 | | |
| 6.0mm | 350-380-060 | 17.5mm | 350-380-175 | | |
| 6.5mm | 350-380-065 | 18.0mm | 350-380-180 | | |
| 7.0mm | 350-380-070 | 18.5mm | 350-380-185 | | |
| 7.5mm | 350-380-075 | 19.0mm | 350-380-190 | | |
| 8.0mm | 350-380-080 | 19.5mm | 350-380-195 | | |
| 8.5mm | 350-380-085 | 20.0mm | 350-380-200 | | |
| 9.0mm | 350-380-090 | 21.0mm | 350-380-210 | | |
| 9.5mm | 350-380-095 | 22.0mm | 350-380-220 | | |
| 10.0mm | 350-380-100 | 23.0mm | 350-380-230 | | |
| 10.5mm | 350-380-105 | | | | |
| 11.0mm | 350-380-110 | | | | |
| 11.5mm | 350-380-115 | | | | |
| 12.0mm | 350-380-120 | | | | |

* illustration does not show the complete set



PRATT

Uterine Dilators, French Scale 10^{3/8}"

| | |
|---------|-------------|
| 13 - 15 | 350-392-015 |
| 17 - 19 | 350-392-019 |
| 21 - 23 | 350-392-023 |
| 25 - 27 | 350-392-027 |
| 29 - 31 | 350-392-031 |
| 33 - 35 | 350-392-035 |
| 37 - 39 | 350-392-039 |
| 41 - 43 | 350-392-043 |

Set of 8 pieces in canvas roll*

350-392-000



HANK

Uterine Dilator

| | | | |
|-------------------------|-------------|--------------------------|-------------|
| Fig. 9/10 4.5/5.0mm | 350-390-010 | Fig. 15/16 7.5/8.0mm | 350-390-016 |
| Fig. 11/12 5.5/6.0mm | 350-390-012 | Fig. 17/18 8.5/9.0mm | 350-390-018 |
| Fig. 13/14 6.5/7.0mm | 350-390-014 | Fig. 19/20 9.5/10.0mm | 350-390-020 |

Set, 6 pieces in canvas roll*

350-391-002

* illustration does not show the complete set

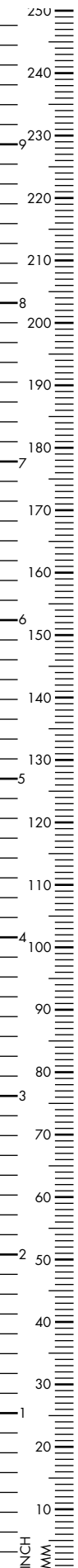

JACKSON

Vaginal Speculum

| | |
|------------|-------------|
| 75 x 38mm | 350-206-001 |
| 90 x 38mm | 350-206-002 |
| 100 x 38mm | 350-206-003 |



EASTMAN

Vaginal Speculum

| | |
|------------|-------------|
| 75 x 38mm | 350-207-001 |
| 90 x 38mm | 350-207-002 |
| 100 x 38mm | 350-207-003 |



DOYEN

Vaginal Speculum, slightly concave

| | |
|------------|-------------|
| 55 x 35mm | 350-290-001 |
| 85 x 35mm | 350-290-002 |
| 115 x 35mm | 350-290-003 |
| 55 x 45mm | 350-290-004 |
| 85 x 45mm | 350-290-005 |
| 115 x 45mm | 350-290-006 |
| 160 x 45mm | 350-290-007 |
| 55 x 60mm | 350-290-008 |
| 85 x 60mm | 350-290-009 |
| 115 x 60mm | 350-290-010 |
| 160 x 60mm | 350-290-011 |



HEANEY

Retractor, 270mm, 10^{2/3}"

| | |
|-----------|-------------|
| 73 x 28mm | 170-459-001 |
| 45 x 28mm | 170-459-002 |
| 82 x 28mm | 170-459-003 |



HEANEY SIMON

Retractor with horn handle

| | |
|----------------------------|-------------|
| 260mm, 10 ^{1/4} " | 170-460-260 |
|----------------------------|-------------|



BREISKY

Vaginal Speculum

| | | | |
|------------|-------------|------------|-------------|
| 100 x 20mm | 350-320-020 | 130 x 20mm | 350-322-020 |
| 100 x 25mm | 350-320-025 | 130 x 25mm | 350-322-025 |
| 100 x 30mm | 350-320-030 | 130 x 30mm | 350-322-030 |
| 100 x 35mm | 350-320-035 | 130 x 35mm | 350-322-035 |
| 100 x 40mm | 350-320-040 | 130 x 40mm | 350-322-040 |
| | | 155 x 40mm | 350-324-040 |

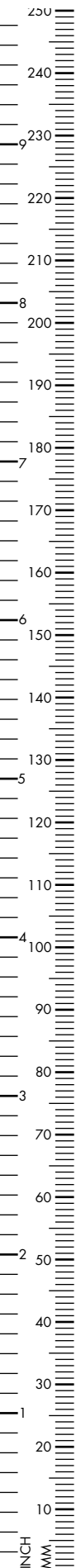

SEIDL

Speculum for children
170mm, 6²/₃"

| | |
|-----------|-------------|
| 80 x 8mm | 350-254-001 |
| 80 x 10mm | 350-254-002 |
| 90 x 14mm | 350-254-003 |



KRISTELLER

Vaginal Speculum, for children

| | |
|------------|-------------|
| 70 x 15mm | 350-210-000 |
| for adults | |
| 70 x 27mm | 350-210-001 |
| 80 x 30mm | 350-210-002 |
| 90 x 36mm | 350-210-003 |



KRISTELLER

Retractor

| | | |
|--------|------------|-------------|
| Fig. 0 | 70 x 10mm | 350-211-000 |
| Fig. 1 | 75 x 23mm | 350-211-001 |
| Fig. 2 | 85 x 26mm | 350-211-002 |
| Fig. 3 | 100 x 32mm | 350-211-003 |



KRISTELLER

Vaginal Speculum Set

| | |
|--------|-------------|
| Fig. 0 | 350-212-000 |
| Fig. 1 | 350-212-001 |
| Fig. 2 | 350-212-002 |
| Fig. 3 | 350-212-003 |



KRISTELLER

Vaginal Speculum

| | | |
|--------|------------|-------------|
| Fig. 1 | 110 x 27mm | 350-230-001 |
| Fig. 2 | 110 x 30mm | 350-230-002 |
| Fig. 3 | 110 x 36mm | 350-230-003 |



KRISTELLER

Retractor

| | | |
|--------|------------|-------------|
| Fig. 1 | 115 x 18mm | 350-231-001 |
| Fig. 2 | 115 x 22mm | 350-231-002 |
| Fig. 3 | 115 x 28mm | 350-231-003 |



KRISTELLER

Vaginal Speculum Set

| | | |
|--------|--|-------------|
| Fig. 1 | | 350-232-001 |
| Fig. 2 | | 350-232-002 |
| Fig. 3 | | 350-232-003 |



SIMS

Vaginal Speculum, small

| | |
|-----------|-------------|
| 65 x 25mm | 350-200-001 |
|-----------|-------------|

medium

| | |
|-----------|-------------|
| 70 x 30mm | 350-200-002 |
|-----------|-------------|

large

| | |
|-----------|-------------|
| 85 x 35mm | 350-200-003 |
|-----------|-------------|

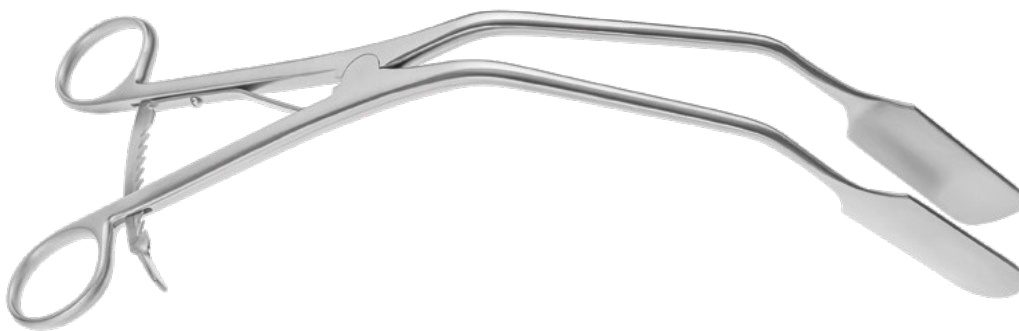

RZ

Lateral Retractor

| | |
|-----------|-------------|
| 60 x 22mm | 350-340-000 |
|-----------|-------------|



KOGAN

Endospeculum, screw ratchet, 240mm, 9^{1/2}"

| | |
|-----|-------------|
| 5mm | 350-361-001 |
|-----|-------------|

| | |
|-----|-------------|
| 4mm | 350-361-002 |
|-----|-------------|

| | |
|-----|-------------|
| 3mm | 350-361-003 |
|-----|-------------|

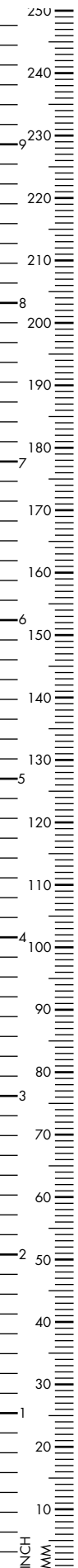



GRAVE

Vaginal Speculum

| | |
|-----------|-------------|
| 75 x 20mm | 350-130-001 |
| 95 x 35mm | 350-130-002 |
| 115 x 35 | 350-130-003 |



PEDERSON

Vaginal Speculum

| | |
|------------|-------------|
| 75 x 13mm | 350-140-001 |
| 100 x 22mm | 350-140-002 |
| 120 x 25mm | 350-140-003 |



CUSCO

Vaginal Speculum

| | |
|------------|-------------|
| 75 x 32mm | 350-100-001 |
| 85 x 35mm | 350-100-002 |
| 100 x 35mm | 350-100-003 |



CUSCO

Vaginal Speculum, Swiss pattern

| | |
|------------|-------------|
| 80 x 22mm | 350-102-001 |
| 100 x 25mm | 350-102-002 |
| 105 x 27mm | 350-102-003 |



SEMN

Vaginal Speculum, 100mm blade

| | |
|--------------------|-------------|
| 17-20mm wide blade | 350-120-001 |
| 25-30mm wide blade | 350-120-002 |



COLLIN

Vaginal Speculum, detachable

| | |
|------------|-------------|
| 65 x 20mm | 350-110-001 |
| 85 x 30mm | 350-110-002 |
| 100 x 35mm | 350-110-003 |
| 100 x 40mm | 350-110-004 |

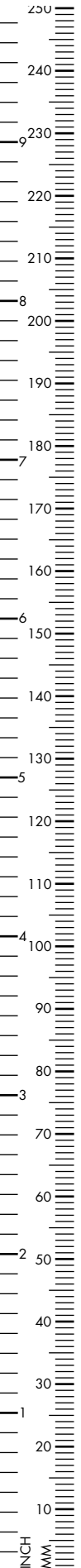



AUVARD

Vaginal Speculum, fixed weight,
1.14kg, 45° angled

| | |
|------------|-------------|
| 70 x 42mm | 350-309-000 |
| 83 x 38mm | 350-310-000 |
| 102 x 45mm | 350-311-000 |



STEINER ANVARD

Vaginal Speculum, fixed weight, 1.14kg

| | |
|------------|-------------|
| 150 x 34mm | 350-311-140 |
|------------|-------------|



SCHERBACK

Vaginal Speculum, complete set
incl. weight 400g, handle, blades Fig. 1 - 5

350-300-000

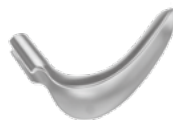

Blades

| | |
|---------|-------------|
| 80x30mm | 330-301-001 |
| 85x35mm | 330-301-002 |
| 85x40mm | 330-301-003 |
| 55x40mm | 330-301-004 |
| 70x45mm | 330-301-005 |



Weight

| | |
|------|-------------|
| 400g | 350-302-001 |
| 800g | 350-302-002 |

Handle

350-303-000



GELPI

Perineal Retractor, pediatric size

| | |
|--|-------------|
| 90mm, 3 ¹ / ₂ " | 170-802-090 |
| 110mm, 4 ¹ / ₃ " | 170-802-110 |
| 135mm, 5 ¹ / ₃ " | 170-802-135 |

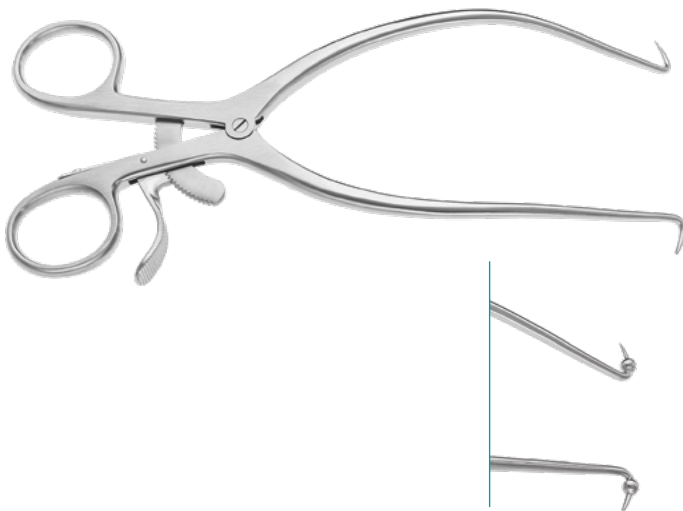

GELPI

Perineal Retractor

| | |
|--|-------------|
| 180mm, 7" | 170-802-180 |
| with ball stops | |
| 190mm, 7 ¹ / ₂ " | 170-803-180 |



RIGBY

Perineal Retractor, 21x70mm blades

| | |
|-----------|-------------|
| 180mm, 7" | 170-806-180 |
|-----------|-------------|

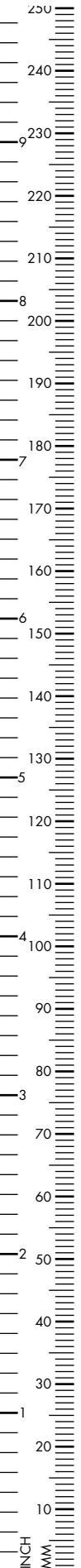



O'SULLIVAN O'CONNOR

Vaginal Retractor Set

350-336-000



RIGBY

Perineal Retractor, 21x70mm blades

180mm, 7"

170-806-180

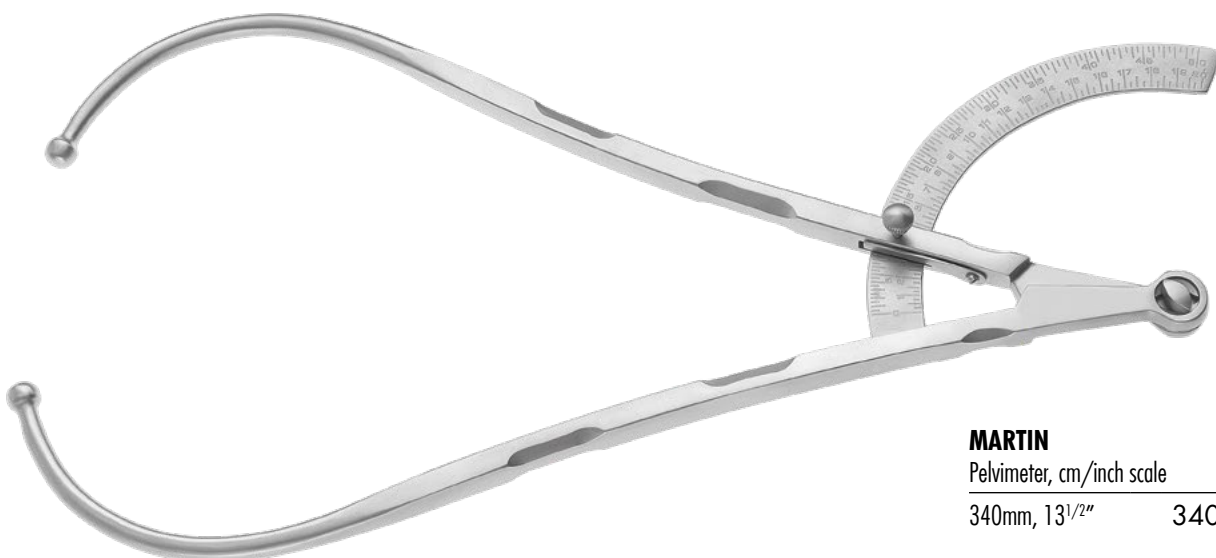

MARTIN

Pelvimeter, cm/inch scale

340mm, 13¹/₂"

340-103-340

