

PLASTIC SURGERY

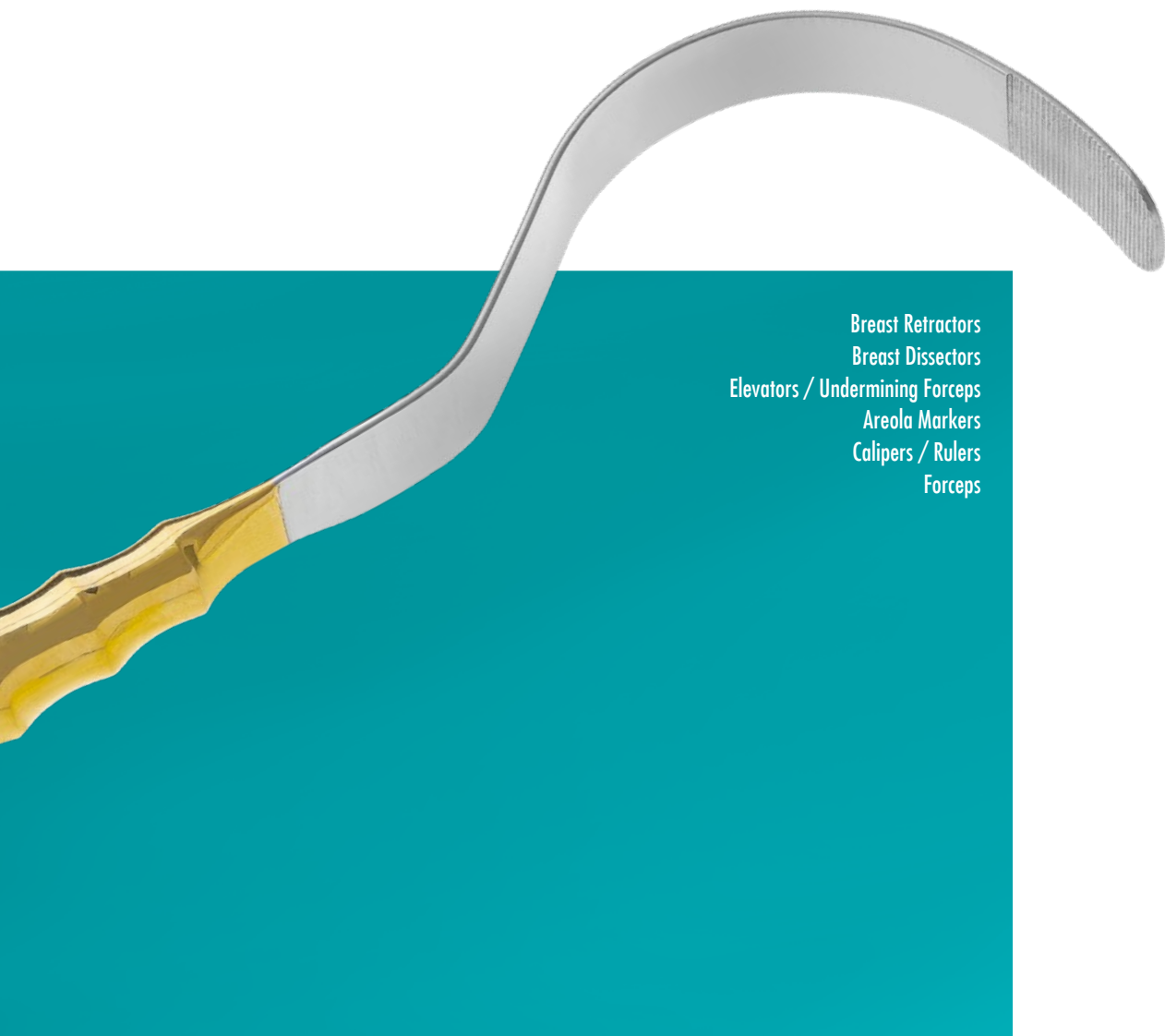

Breast Retractors
Breast Dissectors
Elevators / Undermining Forceps
Areola Markers
Calipers / Rulers
Forceps



FERREIRA STYLE

Breast Retractor, round and smooth blade, with fibre-optic and suction

70 x 16mm	260-070-116
70 x 25mm	260-070-125
90 x 24mm	260-090-124
90 x 27mm	260-090-127
90 x 30mm	260-090-130
100 x 25mm	260-100-125
120 x 25mm	260-120-125
150 x 25mm	260-150-125
150 x 30mm	260-150-130
150 x 36mm	260-150-136
180 x 25mm	260-180-125
180 x 30mm	260-180-130
190 x 36mm	260-190-136



FERREIRA STYLE

Breast Retractor, round and smooth blade, with fibre-optic

70 x 16mm	260-070-916
70 x 25mm	260-070-925
90 x 24mm	260-090-924
90 x 27mm	260-090-927
90 x 30mm	260-090-930
100 x 25mm	260-100-925
110 x 25mm	260-110-925
120 x 25mm	260-120-925
150 x 25mm	260-150-925
150 x 30mm	260-150-930
190 x 36mm	260-190-936
180 x 30mm	260-180-930
190 x 36mm	260-190-936



TEBBET STYLE

Breast Retractor, square and toothed blade, with fibre-optic and suction

70 x 16mm	260-070-316
70 x 25mm	260-070-325
80 x 16mm	260-090-324
90 x 27mm	260-090-327
90 x 30mm	260-090-330
100 x 25mm	260-100-325
110 x 25mm	260-110-325
120 x 25mm	260-120-325
150 x 25mm	260-150-325
150 x 30mm	260-150-330
150 x 36mm	260-150-336
180 x 25mm	260-180-325
180 x 30mm	260-180-330
190 x 36mm	260-190-336



TEBBET STYLE

Breast Retractor, square and smooth blade, with fibre-optic and suction

70 x 16mm	260-070-516
70 x 25mm	260-070-525
80 x 16mm	260-090-524
90 x 27mm	260-090-527
90 x 30mm	260-090-530
100 x 25mm	260-100-525
110 x 25mm	260-110-525
120 x 25mm	260-120-525
150 x 25mm	260-150-525
150 x 30mm	260-150-530
150 x 36mm	260-150-536
180 x 25mm	260-180-525
180 x 30mm	260-180-530
190 x 36mm	260-190-536



Breast Optic Retractor,
Ø 10mm optic, with stopcock

180 x 16mm for 4mm scopes	260-130-160
------------------------------	-------------

180 x 25mm for 4mm scopes	260-130-000
------------------------------	-------------

180 x 25mm for 5mm scopes	260-130-014
------------------------------	-------------

for use with Optic
Ø 10mm, 175mm, 6^{7/8}" working length

30°	260-110-030
-----	-------------

0°	260-110-000
----	-------------

Ø 4mm

30°	260-104-030
-----	-------------



A Mammary Retractor, solid blade,
for Ø 10mm optic, universal scope connection

120 x 25mm	260-145-250
------------	-------------



B BIGGS
Mammary Retractor, fenestrated blade,
31mm

for 10mm scopes	260-135-000
-----------------	-------------

for 4mm scopes	260-135-004
----------------	-------------

for 5mm scopes	260-135-005
----------------	-------------

50mm

for 10mm scopes	260-145-000
-----------------	-------------



DEAVER

Retractor with Silicone Handle, with fibre-optic
 35 x 300mm 260-293-300



Universal Adaptor for fibre-optic retractors

1 piece 260-990-999



Mammary Retractor, fenestrated blade, fibre-optic with universal adapter, suction tube

31mm blade 260-131-000

50mm blade 260-141-000



SALDHANA

Breast Retractor, 8 prongs,
with light guide

125 x 60mm	260-060-125
200 x 60mm	260-060-200

without light guide

125 x 60mm	260-061-185
200 x 60mm	260-061-200



SALDHANA SZ

Retractor, 165mm hitches

155 x 60mm	260-015-155
------------	-------------

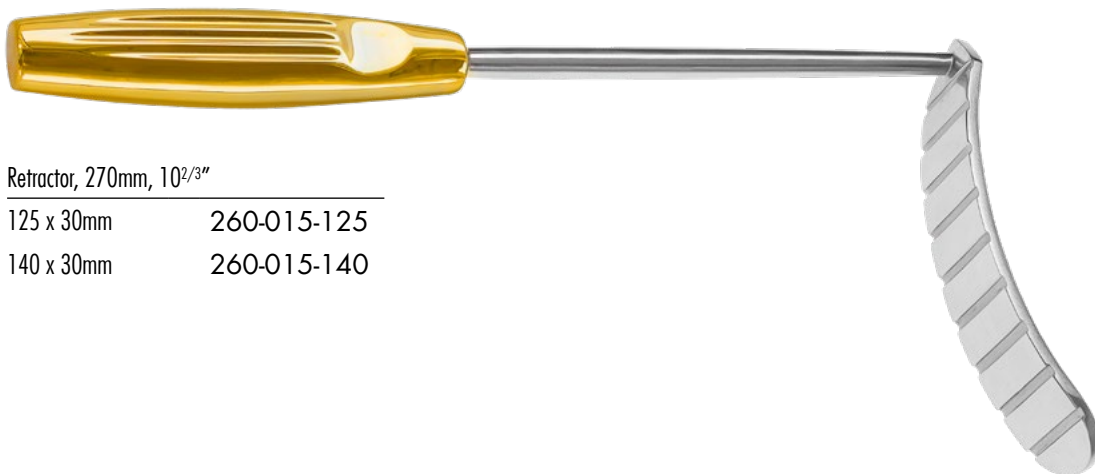

Retractor, 270mm, 10²/₃"

125 x 30mm	260-015-125
140 x 30mm	260-015-140

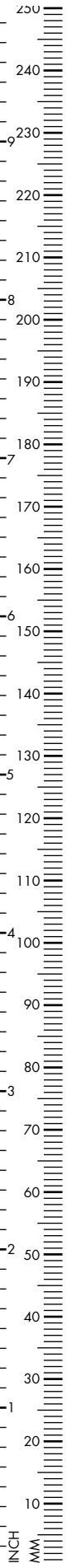

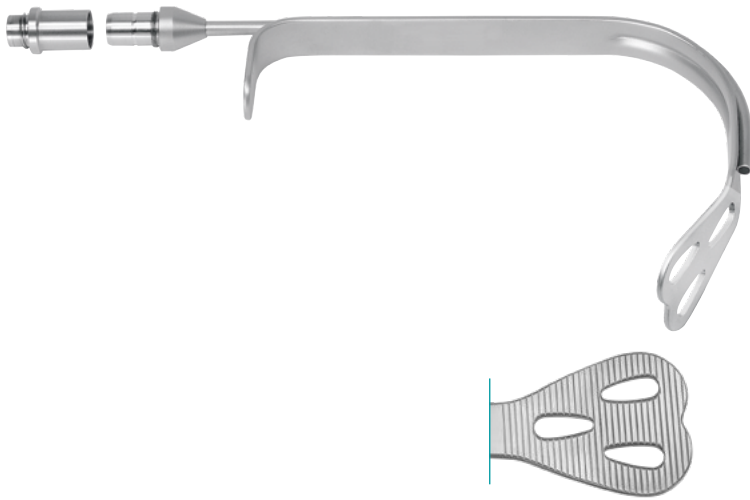

Breast and Facial Retractor, fenestrated blade,
fine serration, fibre-optic, 125mm, 5"

30mm blade 430-497-141

40mm blade 430-497-151



DEAVER

Retractor, with fibre-optic, 230mm, 9"

110 x 25mm 170-581-230

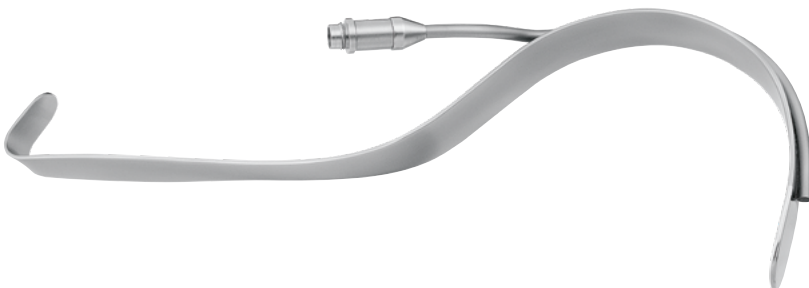

DEAVER

Retractor, with fibre-optic, 300mm, 11⁷/₈"

25mm blade 170-581-300



FERREIRA

Facelift Retractor, 110 x 22mm, 100mm 4"

with fibre-optic 260-130-110

without fibre-optic 260-230-110

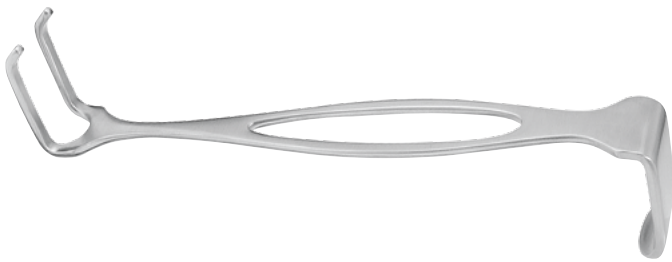

CZERNY

Retractor, 38 x 42mm prongs, 180mm 7"

36mm blade 170-653-000



DEAVER

Grip Retractor, serrated

25 x 300mm 171-483-025

38 x 310mm 171-483-138

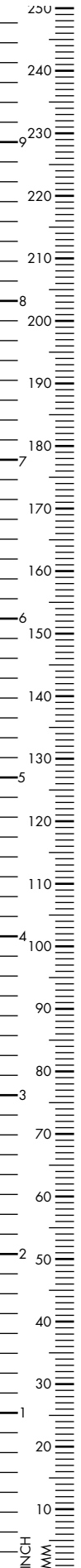



FREEMAN

Flap Retractor, 205mm, 8¹/₈"

12mm wide 260-012-205

25mm wide 260-025-205



SOLZ

Hook Dissector, graduated

360mm, 14¹/₂" 260-001-360



SOLZ

Atraumatic Breast Dissector

340mm, 13³/₄" 260-001-340

370mm, 14³/₄" 260-001-370



SCULPO

Breast Retractor, double-ended,
37 x 70mm / 22 x 54mm

230mm, 9"	260-400-310
-----------	-------------

310mm, 12 ¹ / ₄ "	260-401-310
---	-------------



TILLEY

Breast Retractor, micro toothing

220mm, 8 ² / ₃ "	260-400-220
--	-------------



SCULPO

Breast Spatula, semi-malleable, serrated,
315mm, 12¹/₃"

150 x 25mm	260-400-315
------------	-------------

150 x 38mm	260-438-315
------------	-------------



YANCOSKIE

Abdominoplasty Retractor, 6 prongs

150mm, 6"	260-013-201
-----------	-------------



SCULPO

Breast Dissector, blunt, curved

340mm, 13¹/₃"

260-009-000



AGRIS DINGMAN

Transaxillary Dissector Set, with scale

360mm, 14"

260-088-370



SCULPO

Breast Dissector, angled

330mm, 13"

260-010-000

420mm, 16¹/₂"

260-010-420

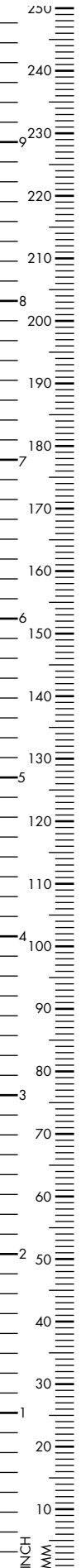

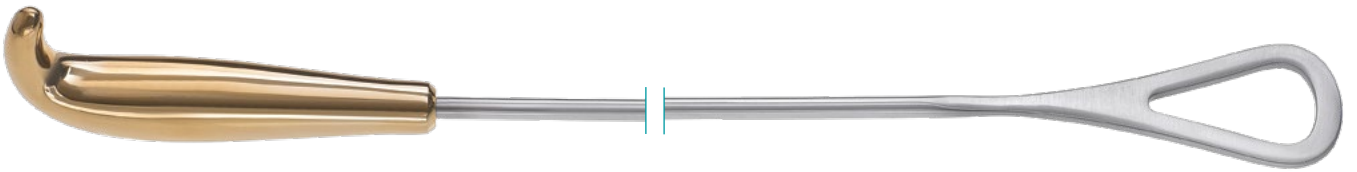

REYNOLDS

Transaxillary Breast Dissector, fenestrated blade

400mm, 15^{3/4}" 260-737-040



REYNOLDS

Breast Dissector, oval spatulated blade

320mm, 12^{2/3}" 260-140-000

420mm, 16^{1/2}" 260-140-420



MACCOLLUM DINGMAN

Breast Dissector, angled shaft

410mm, 16" 260-016-410



SCULPO

Spatulated Breast Dissector, malleable shaft

330mm, 13" 260-311-000

420mm, 16^{1/2}" 260-311-420



Breast Facial Spreader, diamond-shaped
29mm blade

220mm, 8 ² / ₃ "	260-001-220
295mm, 11 ² / ₃ "	260-001-295



Breast Elevator for Mammoplasty

280mm, 11"	260-500-000
------------	-------------

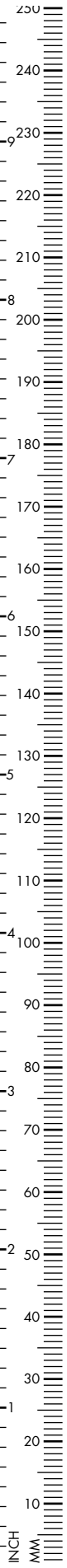



LAROE

Undermining Forceps, curved

245mm, 9 ² / ₃ "	260-001-250
--	-------------

300mm, 11 ⁷ / ₈ "	260-001-300
---	-------------

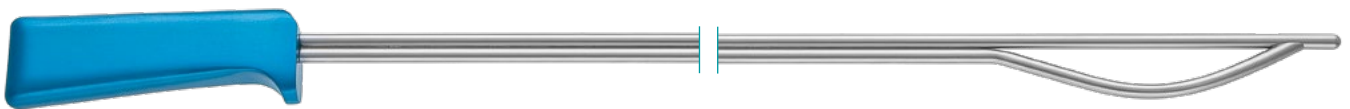

LOCKWOOD

Underminer, 30mm lift

380mm, 15"	260-603-380
------------	-------------

450mm, 19"	260-603-450
------------	-------------



FREEMAN

Areola Marker

Ø 25mm	260-750-125
Ø 30mm	260-750-130
Ø 34mm	260-750-134
Ø 36mm	260-750-136
Ø 38mm	260-750-138
Ø 40mm	260-750-140
Ø 42mm	260-750-142
Ø 45mm	260-750-145
Ø 50mm	260-750-150
Ø 52mm	260-750-152

FREEMAN

Areola Marker, double-ended

Ø 38 / 42mm	260-751-125
Ø 42 / 45mm	260-751-142

FREEMAN

Areola Marker, double-ended, with markings

Ø 38 / 42mm	260-751-225
Ø 34 / 36mm	260-751-236
Ø 45 / 50mm	260-751-250

Areola Marker

Ø 36mm	260-755-036
Ø 38mm	260-755-038
Ø 42mm	260-755-042
Ø 45mm	260-755-045

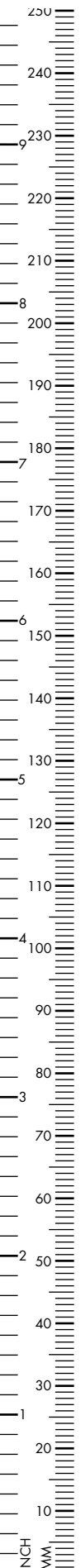



GROSSMANN

Areola Marker, 4-in-1 sizes, non-cutting

Ø 40 / 44 /	260-754-000
48 / 52mm	



GALVAO

Areola Marker

Ø 40mm	260-753-040
Ø 50mm	260-753-050

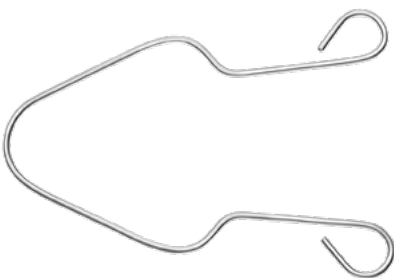

Areola Marker

100mm, 4"	260-746-000
-----------	-------------



ECKHOFF

Skin Marking Pen,
with reversible holder for pen

145mm, 5 ³ / ₄ "	420-832-145
--	-------------

Spare nib (1 piece)

420-832-001

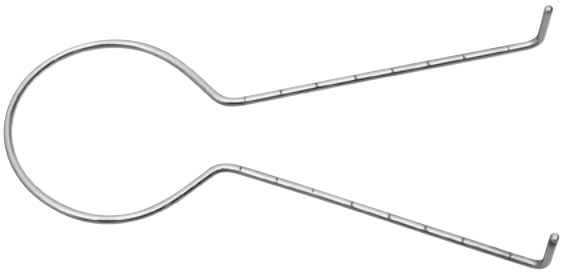

MCKISSOCK

Breast Caliper

Ø 38mm	260-738-000
Ø 42mm	260-742-000
Ø 45mm	260-745-000



HALPERN

Breast Caliper

Ø 38mm	260-755-000
Ø 42mm	260-757-000



Ruler, with mm inch markings

150mm, 6"	100-418-150
200mm, 8"	100-418-200
300mm, 11 ⁷ / ₈ "	100-418-300
500mm, 20"	100-418-500

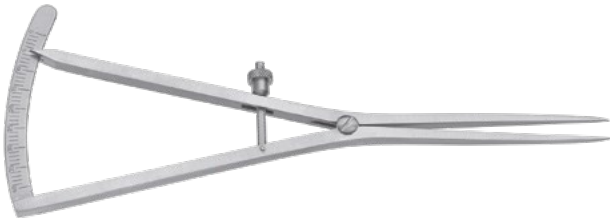

CASTROVIEJO

Caliper, with locking screw

0-20mm, 85mm	400-583-007
--------------	-------------

0-40mm, 180mm	400-583-008
---------------	-------------

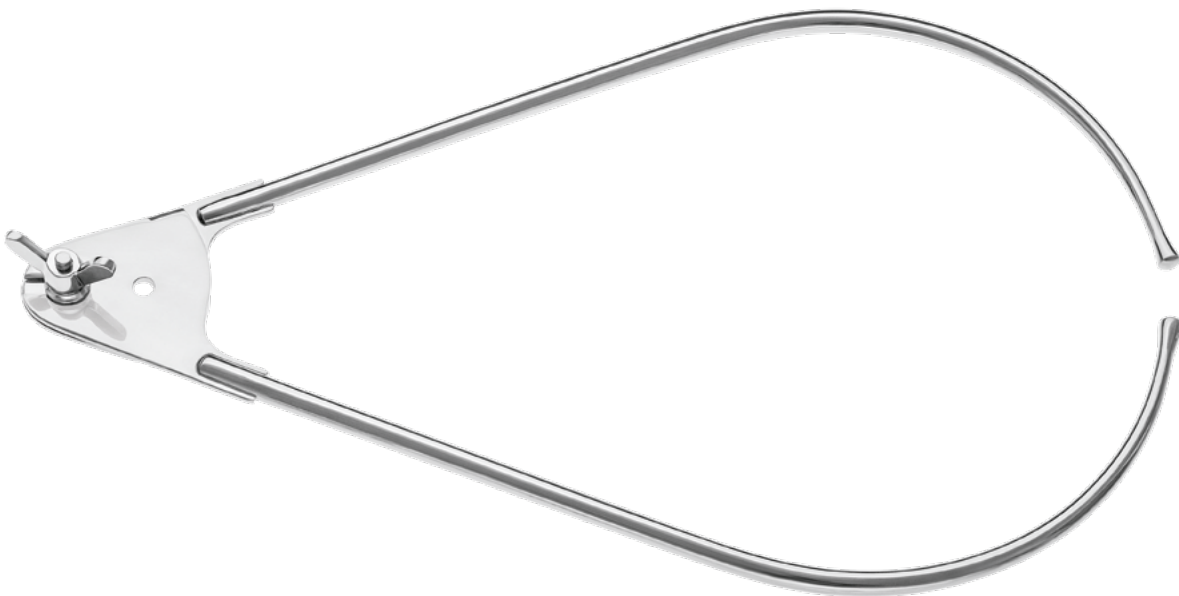

MCKISSOCK (COLLYER)

Caliper

300mm, 11 ⁷ / ₈ "	260-756-300
---	-------------



D'ASSUMPCAO

Face Lift Forceps

160mm, 6 ¹ / ₄ "	260-520-010
260mm, 10 ¹ / ₄ "	260-520-016



D'ASSUMPCAO

Face Lift Forceps, with ratchet

160mm, 6 ¹ / ₄ "	260-520-020
260mm, 10 ¹ / ₄ "	260-520-026

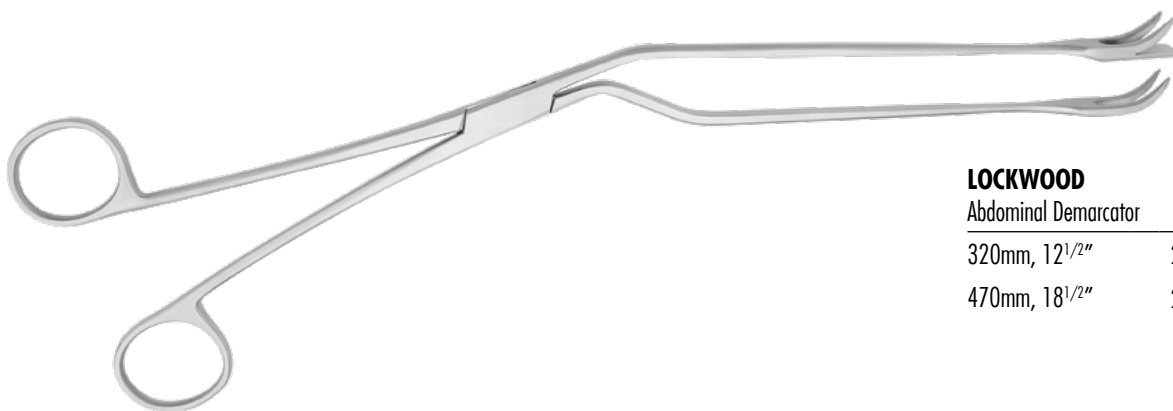

LOCKWOOD

Abdominal Demarcator

320mm, 12 ¹ / ₂ "	260-268-310
470mm, 18 ¹ / ₂ "	260-268-410

