

ARTHROSCOPY

Knee

ACL / PCL SET
225-000-000

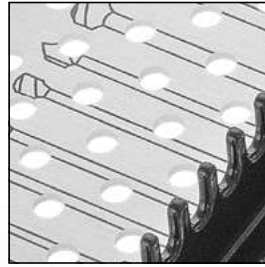

Predestined instrument areas for useful composing

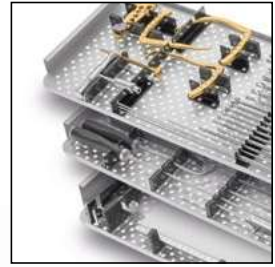

Complete, multi-layered, cost-efficient set

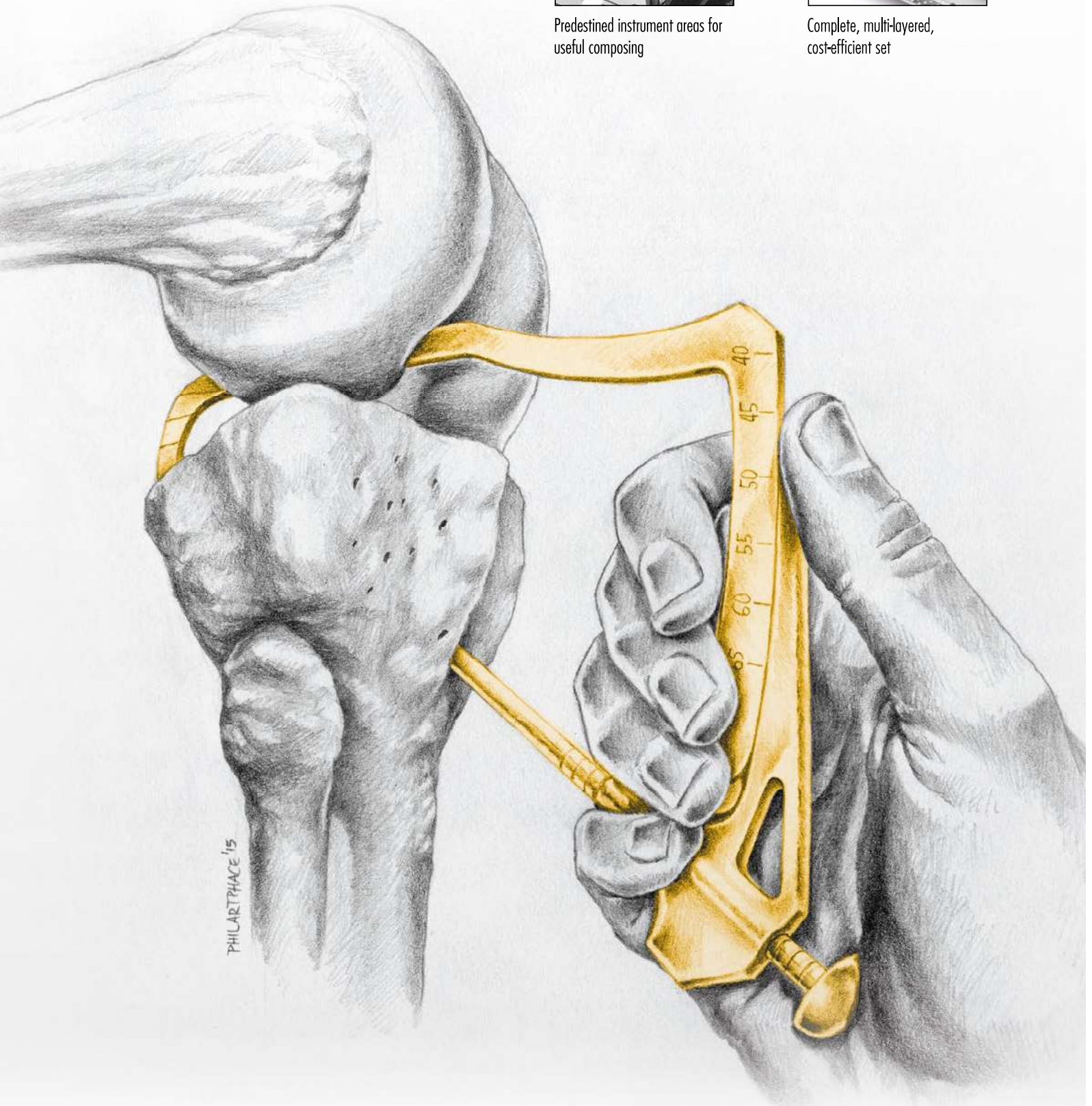

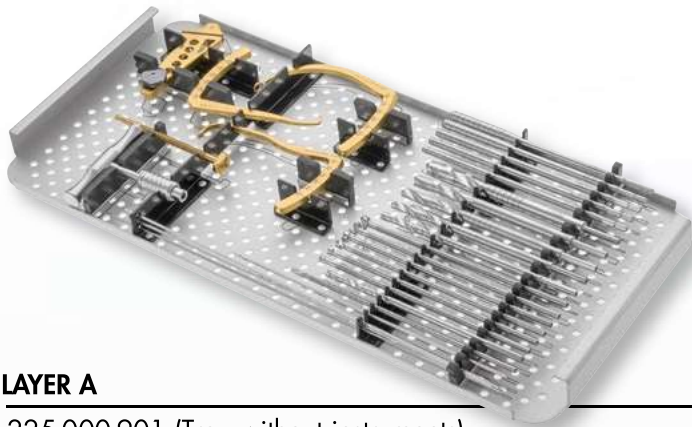

LAYER A

225-000-901 (Tray without instruments)

- Drill Guide System
- Tunnel Dilators
- Cannulated Tibial Reamers
- Cannulated Femoral Reamers
- Endoscopic Reamers
- Guide Wire Screws

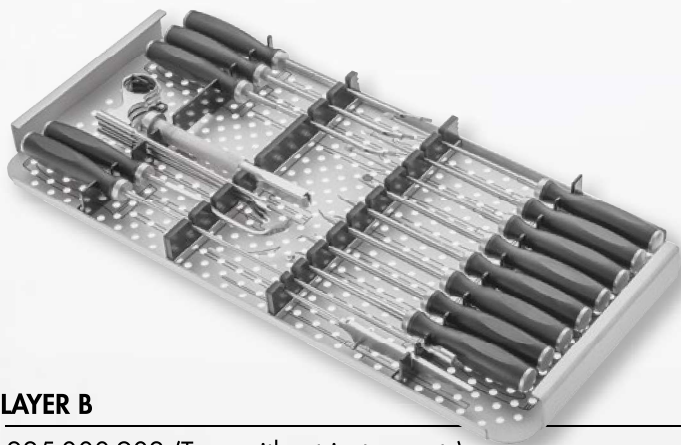

LAYER B

225-000-902 (Tray without instruments)

- Microfracture Chondro Picks
- Impactor
- Transportal Femoral Offset Guide
- PCL Rasp and Elevators
- Tendon Strippers
- Arthroscopic Probes

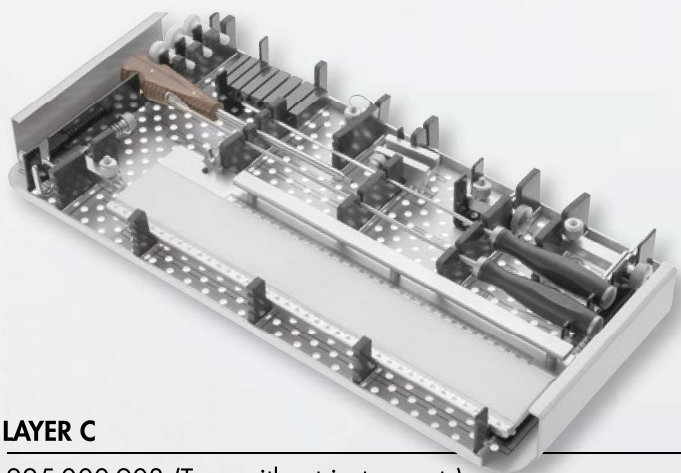

LAYER C

225-000-903 (Tray without instruments)

- Graft Preparation Station
- Graft Sizing Block
- Tunnel Plugs
- Tendon Strippers
- Cannulated Screwdriver
- Depth Gauges

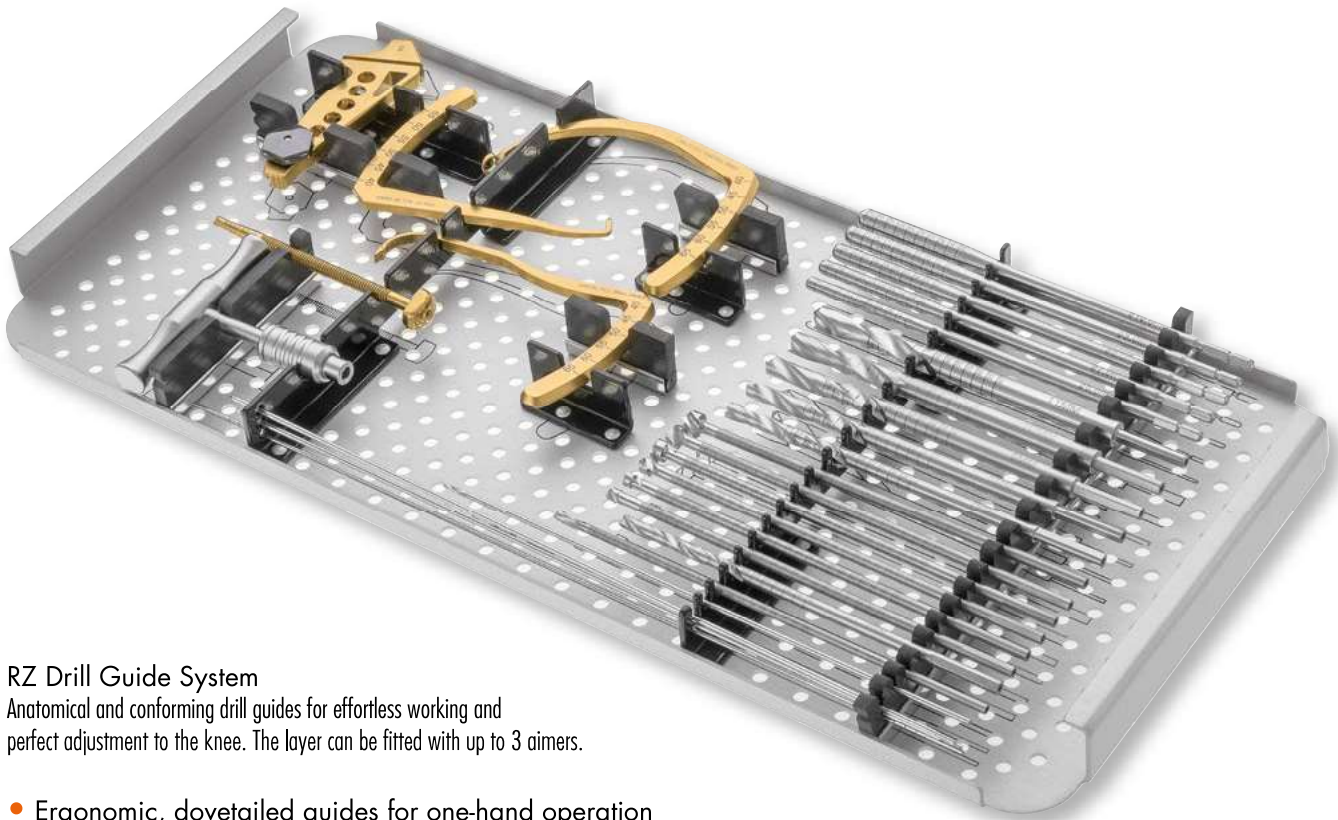

RZ Drill Guide System

Anatomical and conforming drill guides for effortless working and perfect adjustment to the knee. The layer can be fitted with up to 3 aimers.

- Ergonomic, dovetailed guides for one-hand operation thanks to locking mechanism
- Lightweight and compact design
- Ergonomic, dove-tailed guides
- Secure placement on the tibia
- Posterior capsule is protected during guide wire drilling



225-001-101 ACL / PCL Handle



225-001-102 ACL / PCL Bullet

ARTHROSCOPY

Knee



1



2

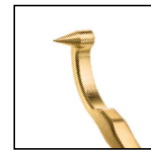

3



4



5



6



7



AIMER

- 1 225-001-105 ACL Tip
- 2 225-001-106 ACL Tip O
- 3 225-001-107 ACL Tip C left
- 4 225-001-108 ACL Tip C right
- 5 225-001-115 PCL Tibial Aimer
- 6 225-001-116 PCL Tibial Aimer
- 7 225-001-117 PCL Femoral Aimer



Used to expand tibial and femoral tunnels while compressing the cancellous bone without drilling

TUNNEL DILATORS / T-HANDLE

- 225-000-406 6mm, cannulated
- 225-000-407 7mm, cannulated
- 225-000-408 8mm, cannulated
- 225-000-409 9mm, cannulated
- 225-000-410 10mm, cannulated
- 225-000-400 T-Handle (suitable for 225-000-406 to -410)



CANNULATED TIBIAL REAMERS

- | | | | |
|-------------|--------|-------------|---------|
| 225-000-060 | 6.0mm | 225-000-095 | 9.5mm* |
| 225-000-065 | 6.5mm* | 225-000-100 | 10.0mm |
| 225-000-070 | 7.0mm | 225-000-105 | 10.5mm* |
| 225-000-075 | 7.5mm* | 225-000-110 | 11.0mm |
| 225-000-080 | 8.0mm | 225-000-115 | 11.5mm* |
| 225-000-085 | 8.5mm* | 225-000-112 | 12.0mm* |
| 225-000-090 | 9.0mm | | |



ENDOSCOPIC REAMER

- 225-000-008 \varnothing 4.7mm, cannulated, 200mm

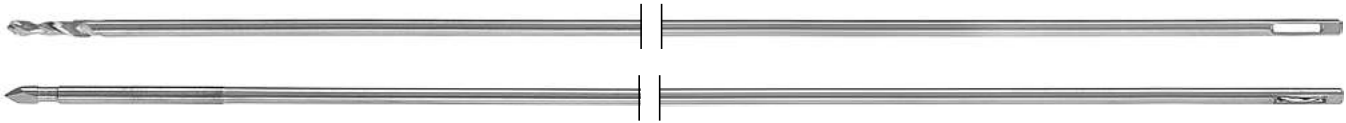

DRILL / GRAFT PASSING GUIDE PINS

225-000-005 Drill bit, \varnothing 2.4mm

225-000-006 Pin, Drill-tip

225-000-007 Pin, Diamond-tip



CANNULATED FEMORAL REAMERS

225-000-260	6.0mm	225-000-295	9.5mm*
225-000-265	6.5mm*	225-000-300	10.0mm
225-000-270	7.0mm	225-000-305	10.5mm*
225-000-275	7.5mm*	225-000-310	11.0mm
225-000-280	8.0mm	225-000-315	11.5mm*
225-000-285	8.5mm*	225-000-312	12.0mm*
225-000-290	9.0mm		



GUIDE WIRE FOR SCREWS

225-000-009 \varnothing 2.0mm

259-120-400 \varnothing 1.2mm (made of Nitinol)

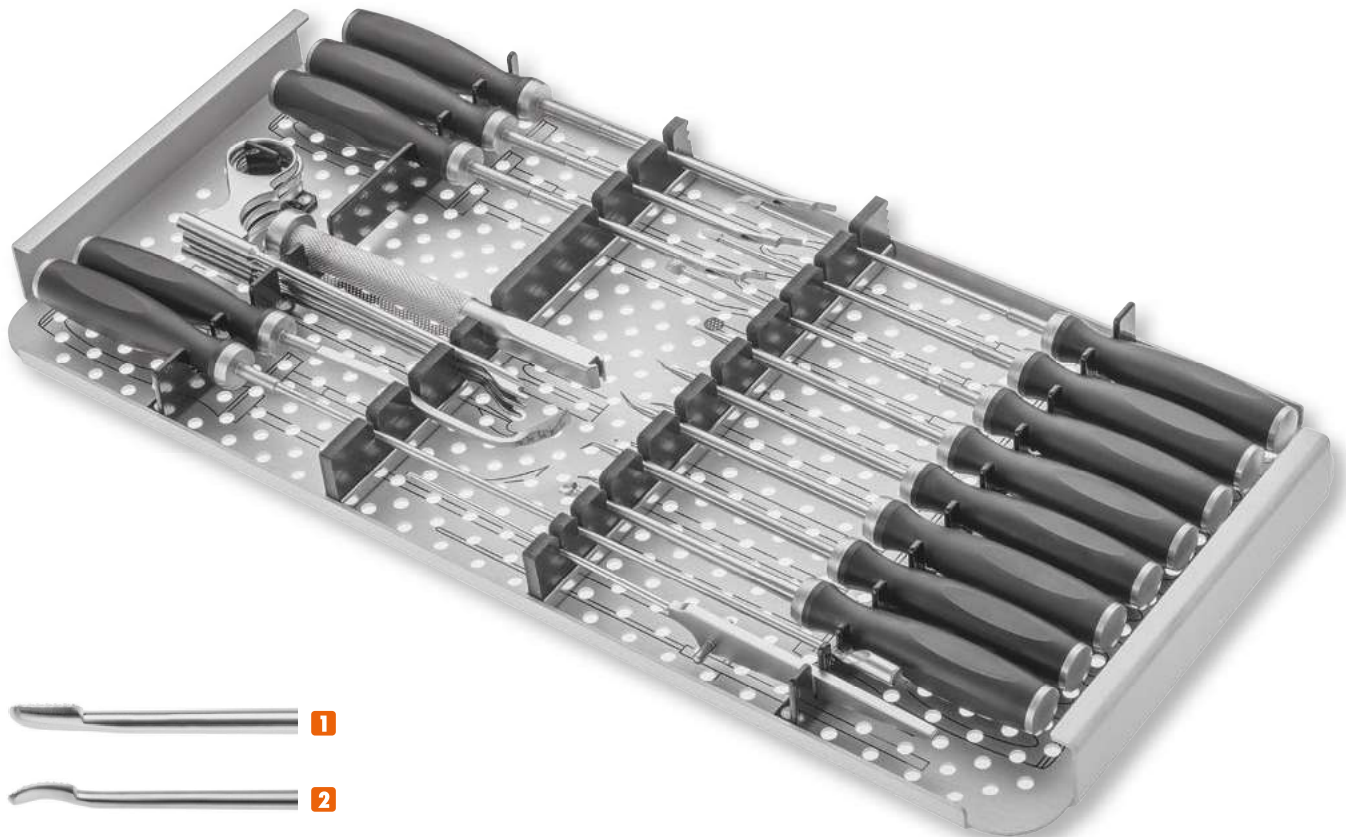

RASPS

- 1** 225-000-500 Straight rasp
- 2** 225-000-501 Convex rasp
- 3** 225-000-502 Half-round rasp

* Item not included in the set and can be ordered separately.



CHONDRO PICKS

- 1** 225-600-200 0° / straight
- 2** 225-600-225 25°
- 3** 225-600-240 40°
- 4** 225-600-260 60°



CURETTE

225-000-507 25° angled down



TRANSPORTAL FEMORAL OFFSET GUIDE

- 225-000-015 5.0mm
- 225-000-016 6.0mm
- 225-000-017 7.0mm

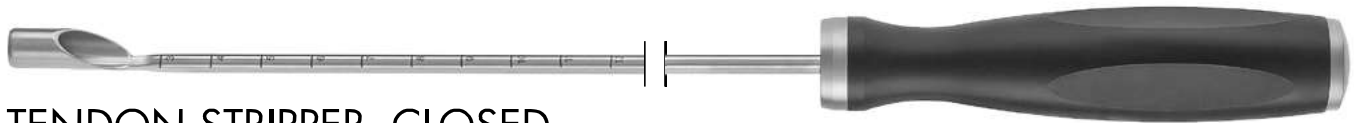

TENDON STRIPPER, CLOSED

- 225-000-606 6.0mm*
- 225-000-607 7.0mm
- 225-000-608 8.0mm*



PCL ELEVATOR

- 225-000-503 with wire capture hole



ARTHROSCOPIC PROBE

- 225-400-002 5mm graduations

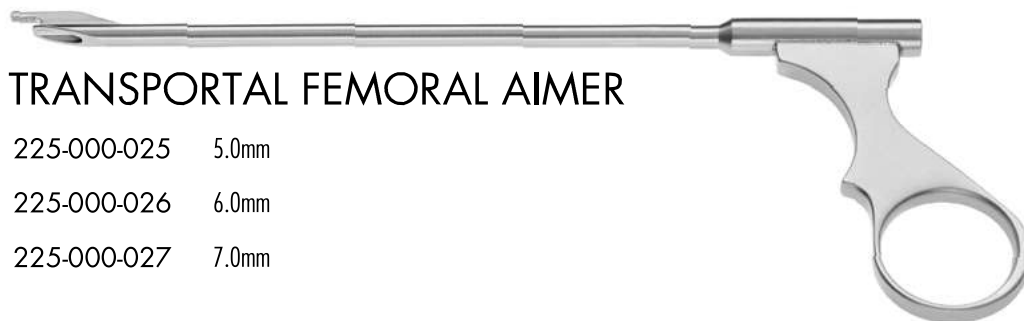

TRANSPORTAL FEMORAL AIMER

- 225-000-025 5.0mm
- 225-000-026 6.0mm
- 225-000-027 7.0mm



IMPACTOR

- 225-000-012 For spiked ligament staple

* Item not included in the set and can be ordered separately.

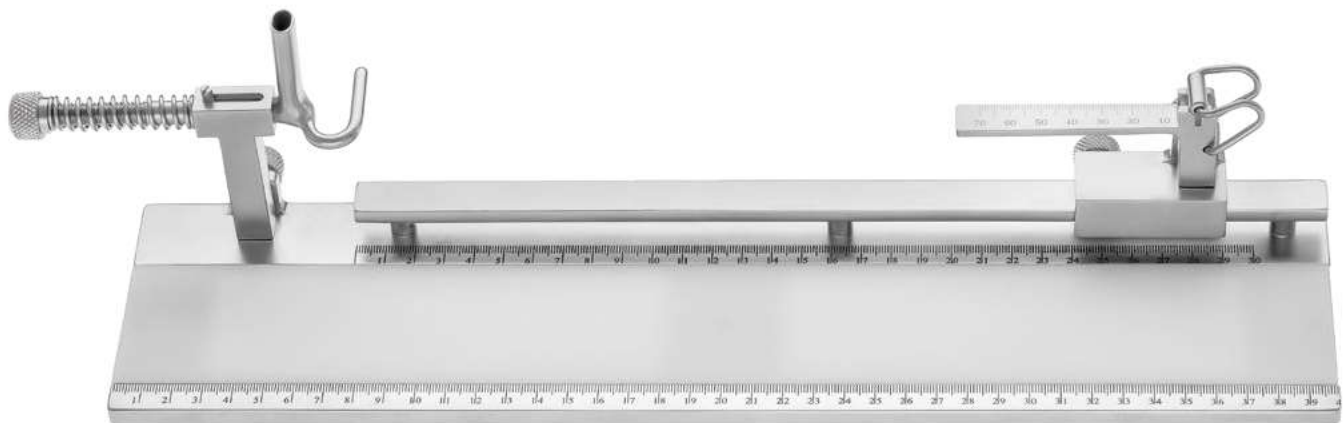
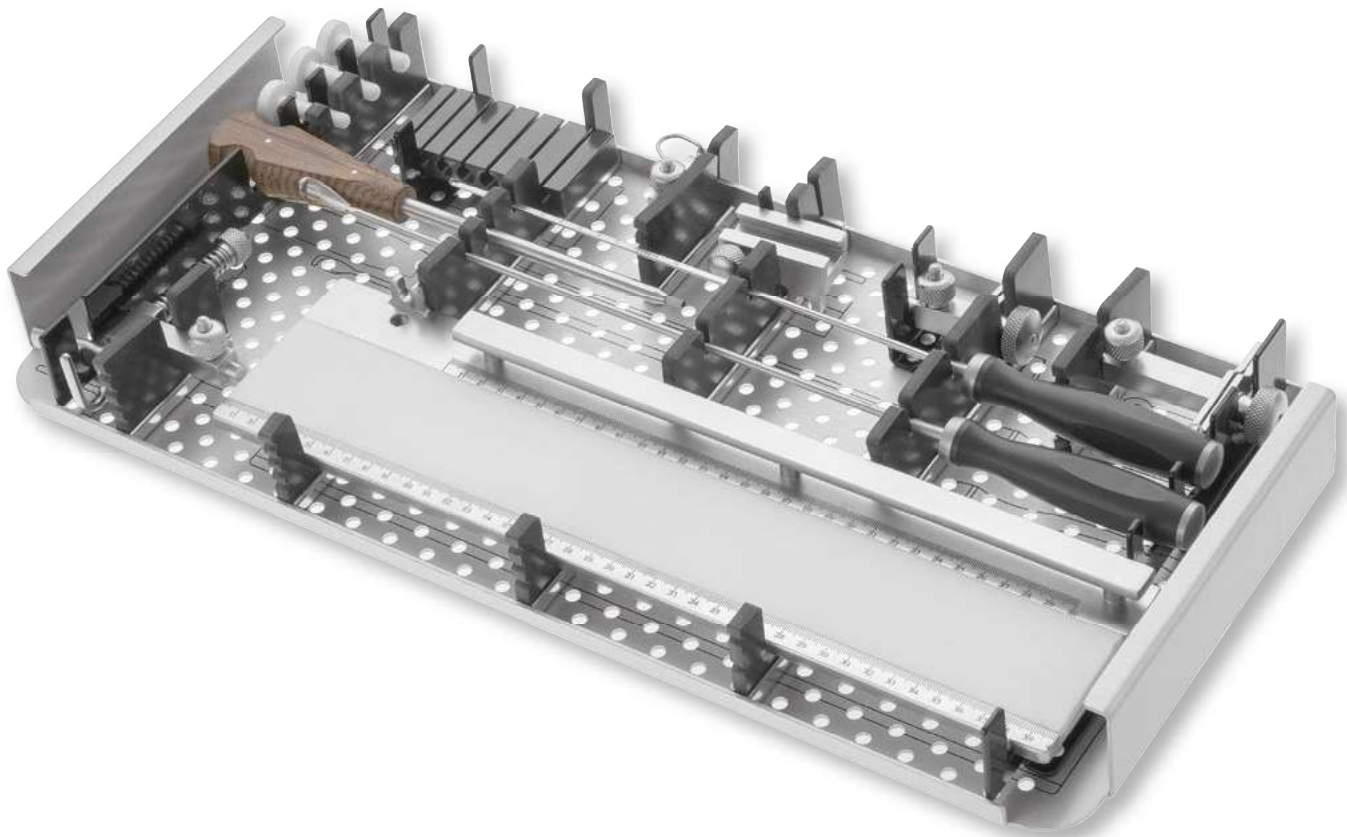

GRAFT PREPERATION STATION

225-000-700 Fully modular system for 6 to 12 increments

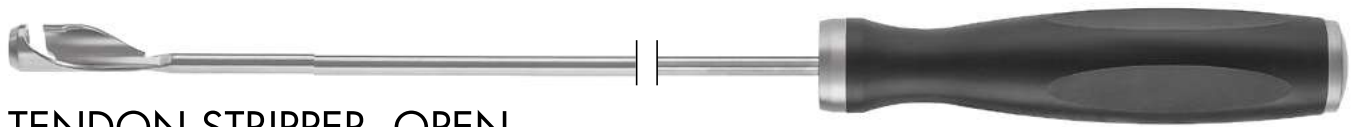

TENDON STRIPPER, OPEN

225-000-616 6.0mm*

225-000-617 7.0mm

225-000-618 8.0mm*

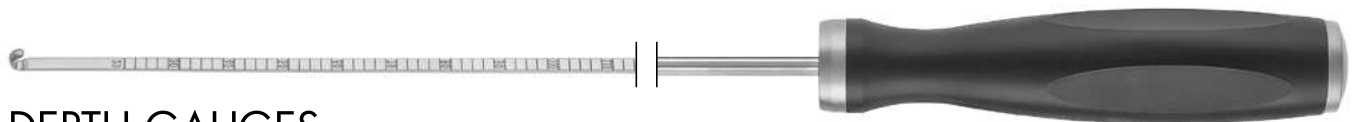

DEPTH GAUGES

225-000-010 For measuring the total length of femoral channel



SCREWDRIVER

225-000-011 Cannulated



GRAFT SIZING BLOCK

225-000-800 From 6mm to 12mm (in 1mm steps)

225-000-801 From 6.5mm to 11.5mm (in 1mm steps)*



TUNNEL PLUGS

225-000-037 7-8mm

225-000-038 8-9mm

225-000-039 9-10mm

* Item not included in the set and can be ordered separately.